

[54] GOLF CLUB HEAD

[76] Inventor: Anthony J. Antonious, 205 E. Joppa Rd., Towson, Md. 21204

[\*] Notice: The portion of the term of this patent subsequent to May 1, 2002 has been disclaimed.

[\*\*] Term: 14 Years

[21] Appl. No.: 653,531

[22] Filed: Sep. 24, 1984

[52] U.S. Cl. .... D21/217

[58] Field of Search ..... D21/217-219; 273/167-175, 163 R, 164, 77 R, 78

[56] References Cited

U.S. PATENT DOCUMENTS

D. 212,890 12/1968 Rose ..... D21/217

D. 240,749 7/1976 Benson ..... D21/219

OTHER PUBLICATIONS

Par Golf 1968 Cat., p. 27, top, item C, Mallet Putter. Golf World, Jul. 13, 1979, top right, "The Wishbone", Putter.

Primary Examiner—Melvin B. Feifer  
Attorney, Agent, or Firm—N. J. Aquilino

[57] CLAIM

The ornamental design for a golf club head, as shown and described.

DESCRIPTION

FIG. 1 is a perspective view of the golf club head showing my new design.

FIG. 2 is a rear elevational view thereof, with a broken line portion of a shaft shown for illustrative purposes only.

FIG. 3 is an end elevational view thereof.

FIG. 4 is a top plan view thereof.

FIG. 5 is an end elevational view taken from the opposite side of FIG. 3.

FIG. 6 is a bottom view thereof.

FIG. 7 is a front elevational view thereof.

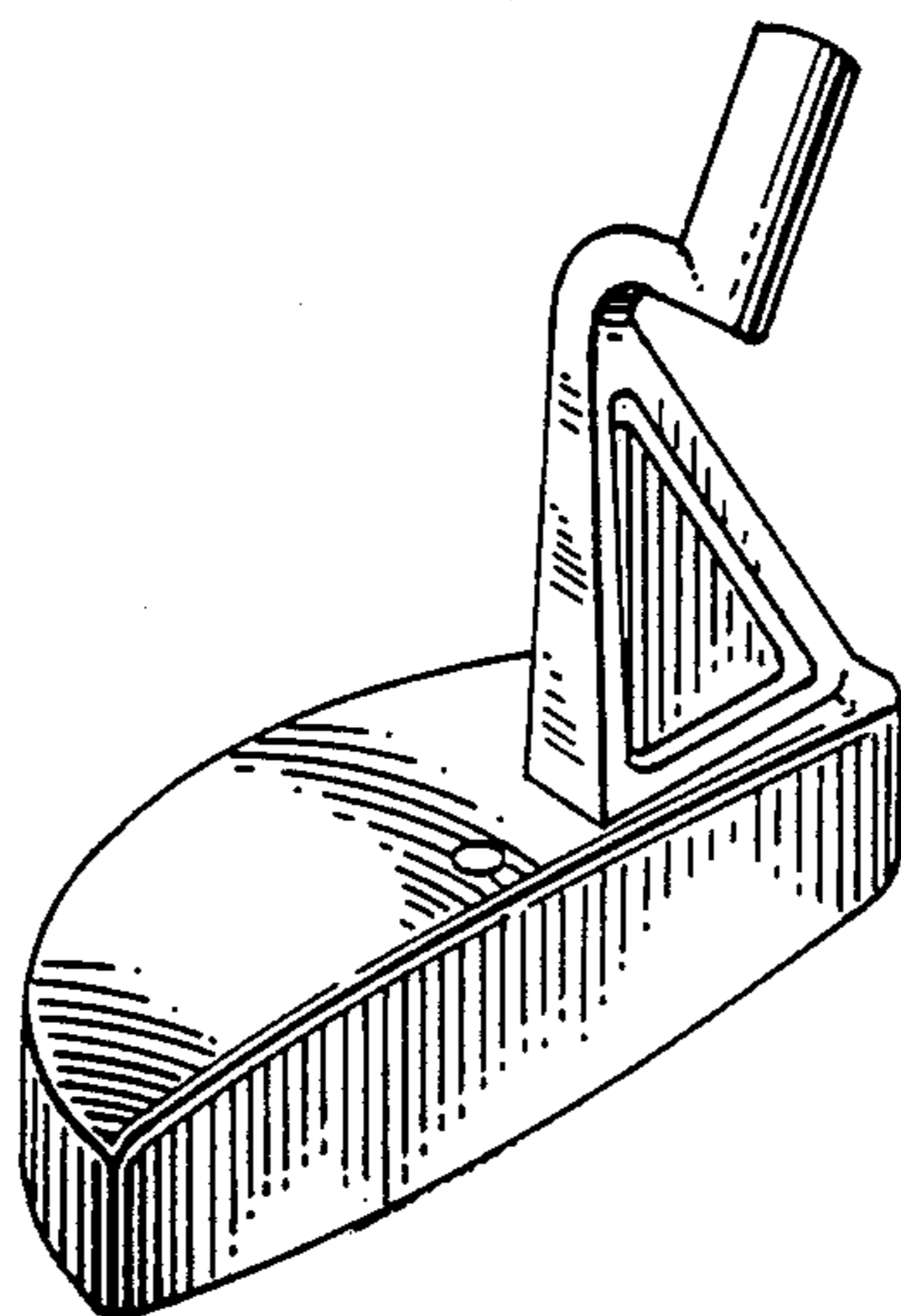

*FIG. 1.*

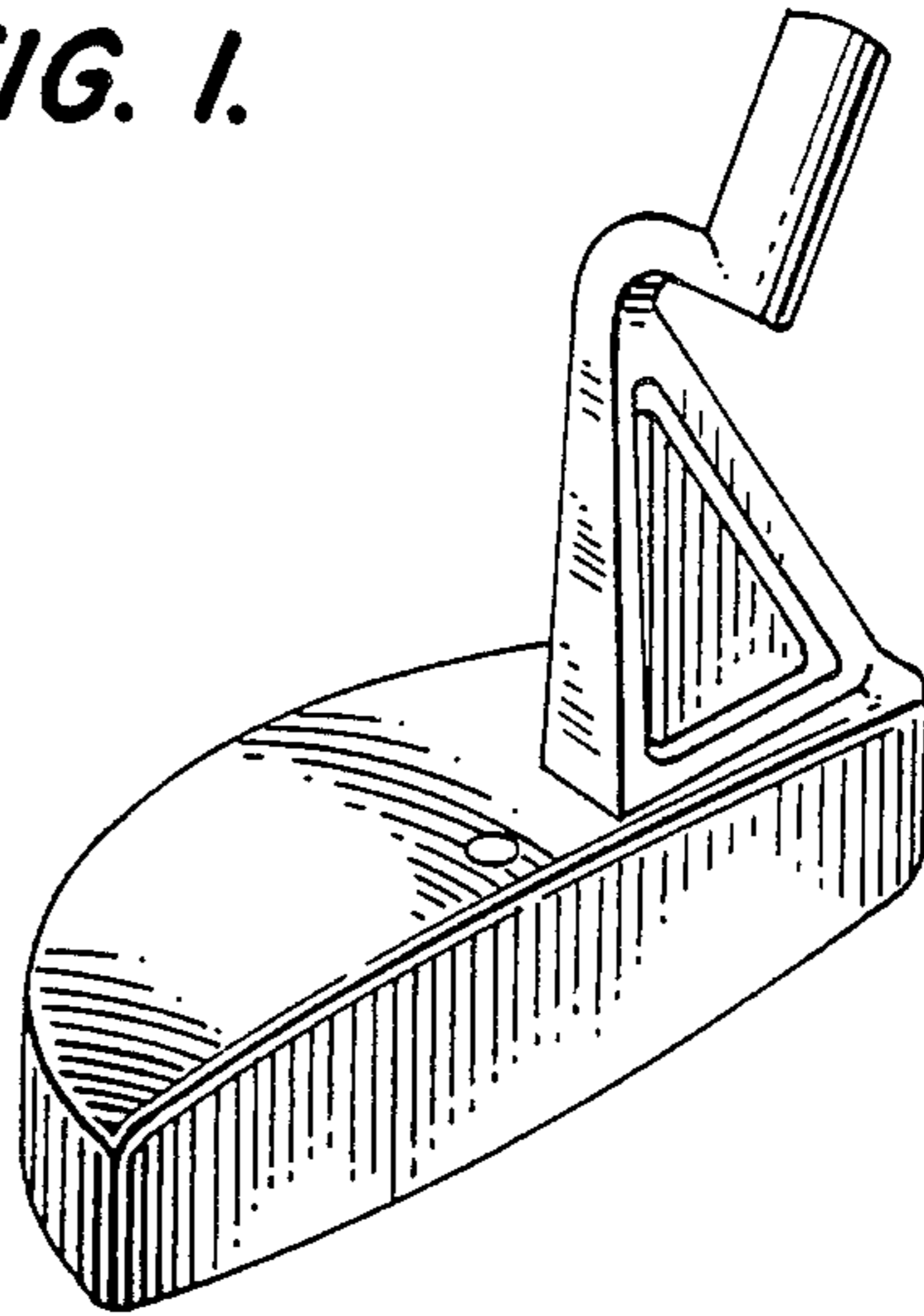

*FIG. 2.*

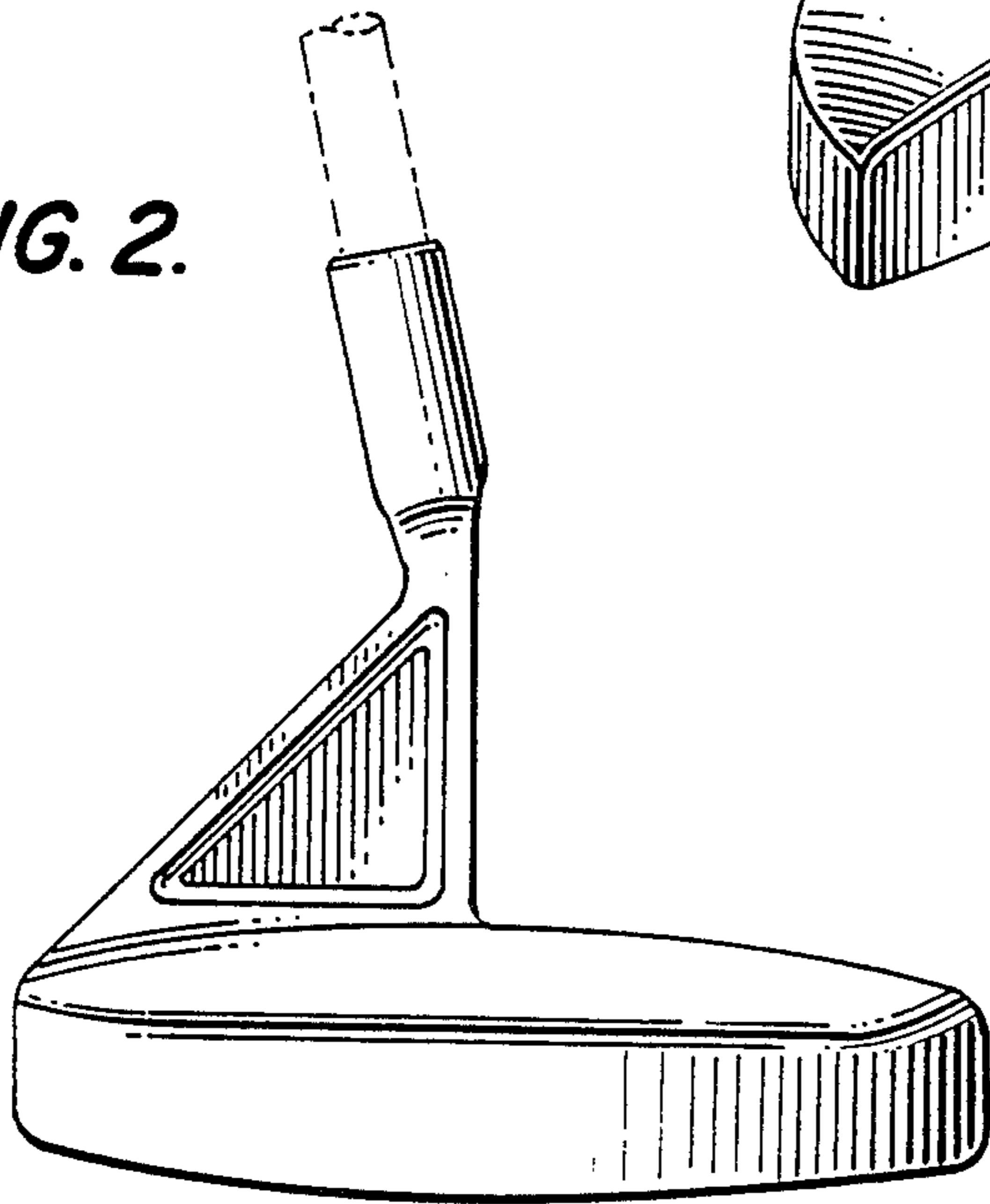

*FIG. 3.*

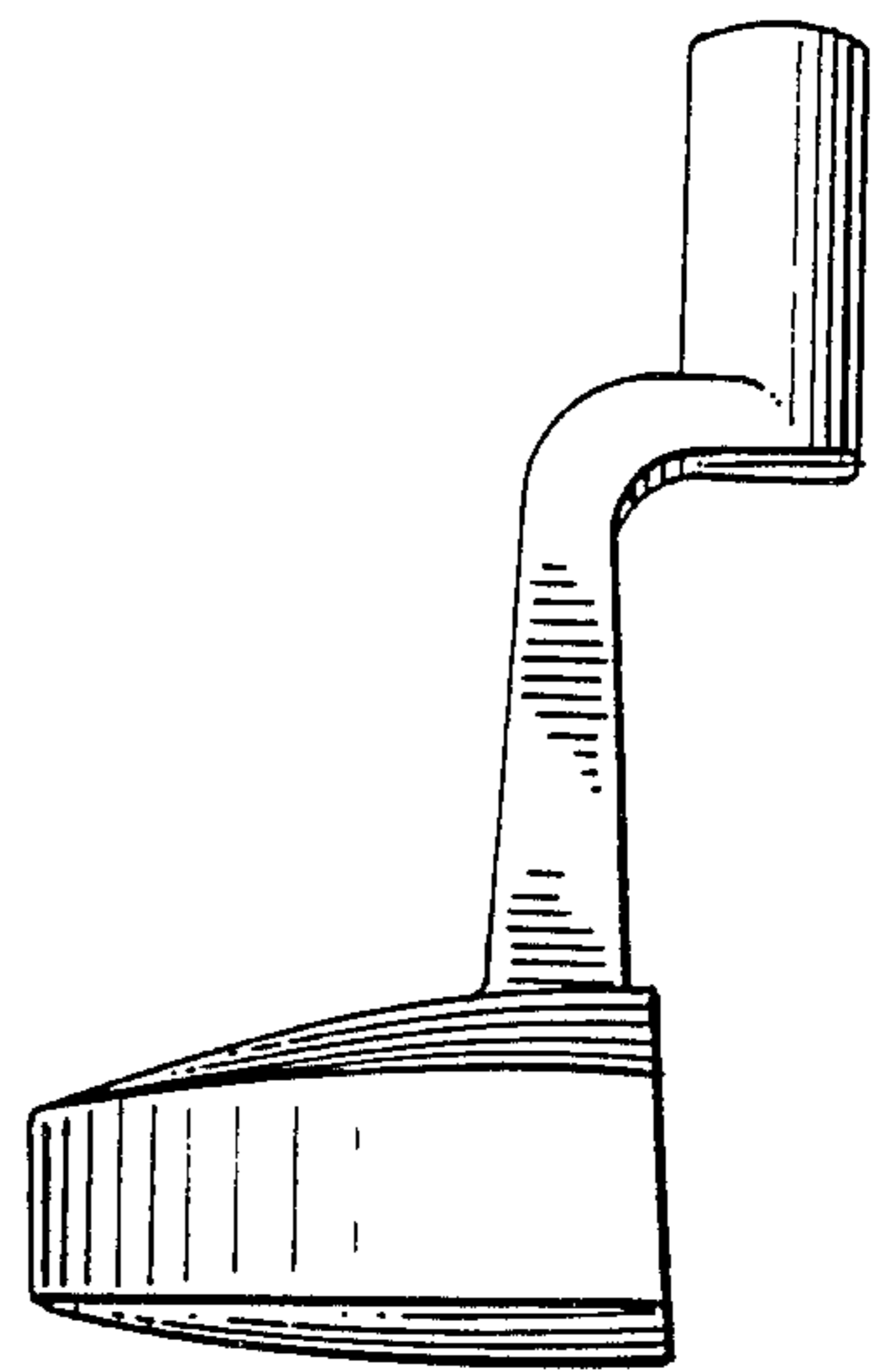

*FIG. 4.*

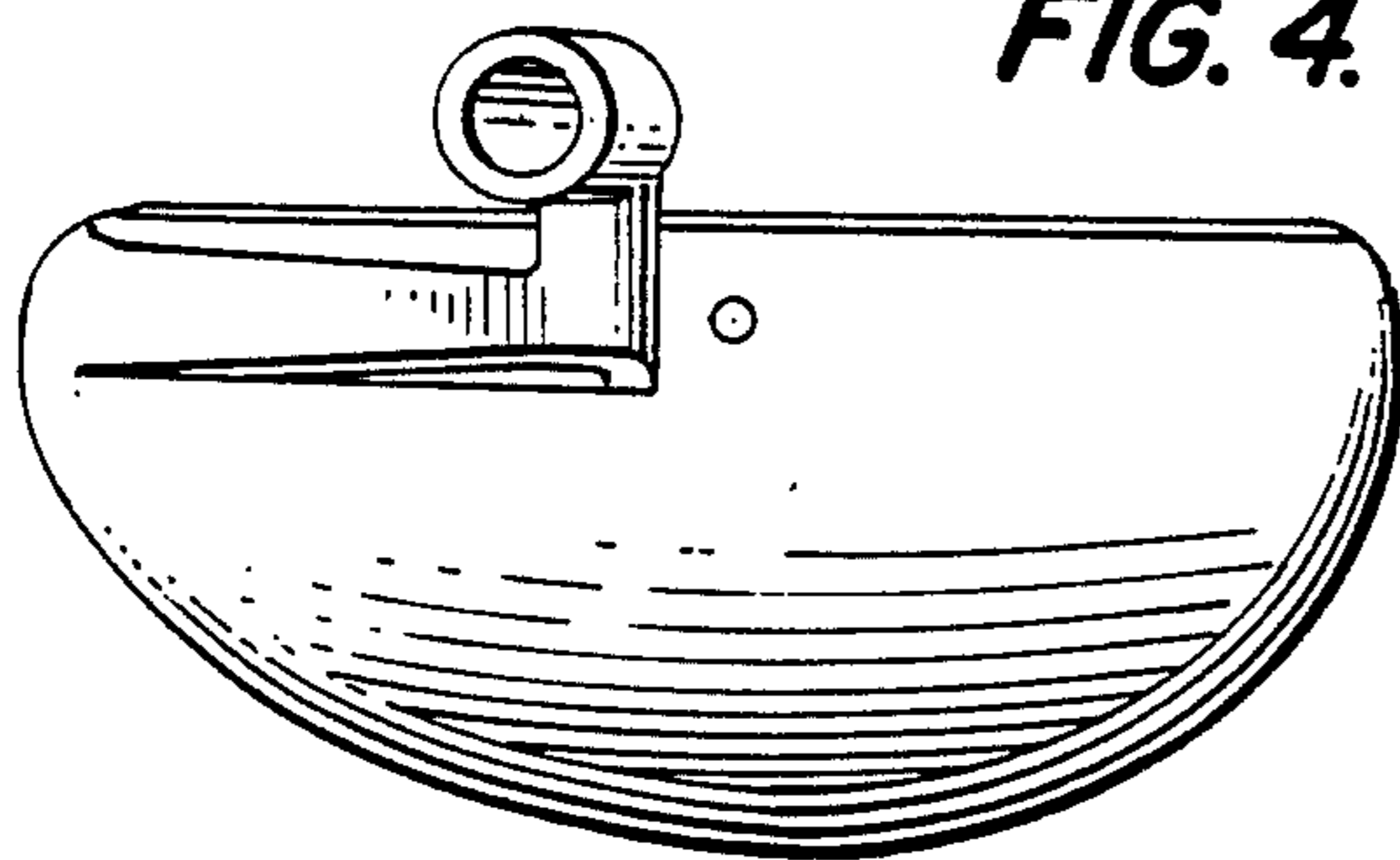

*FIG. 5.*

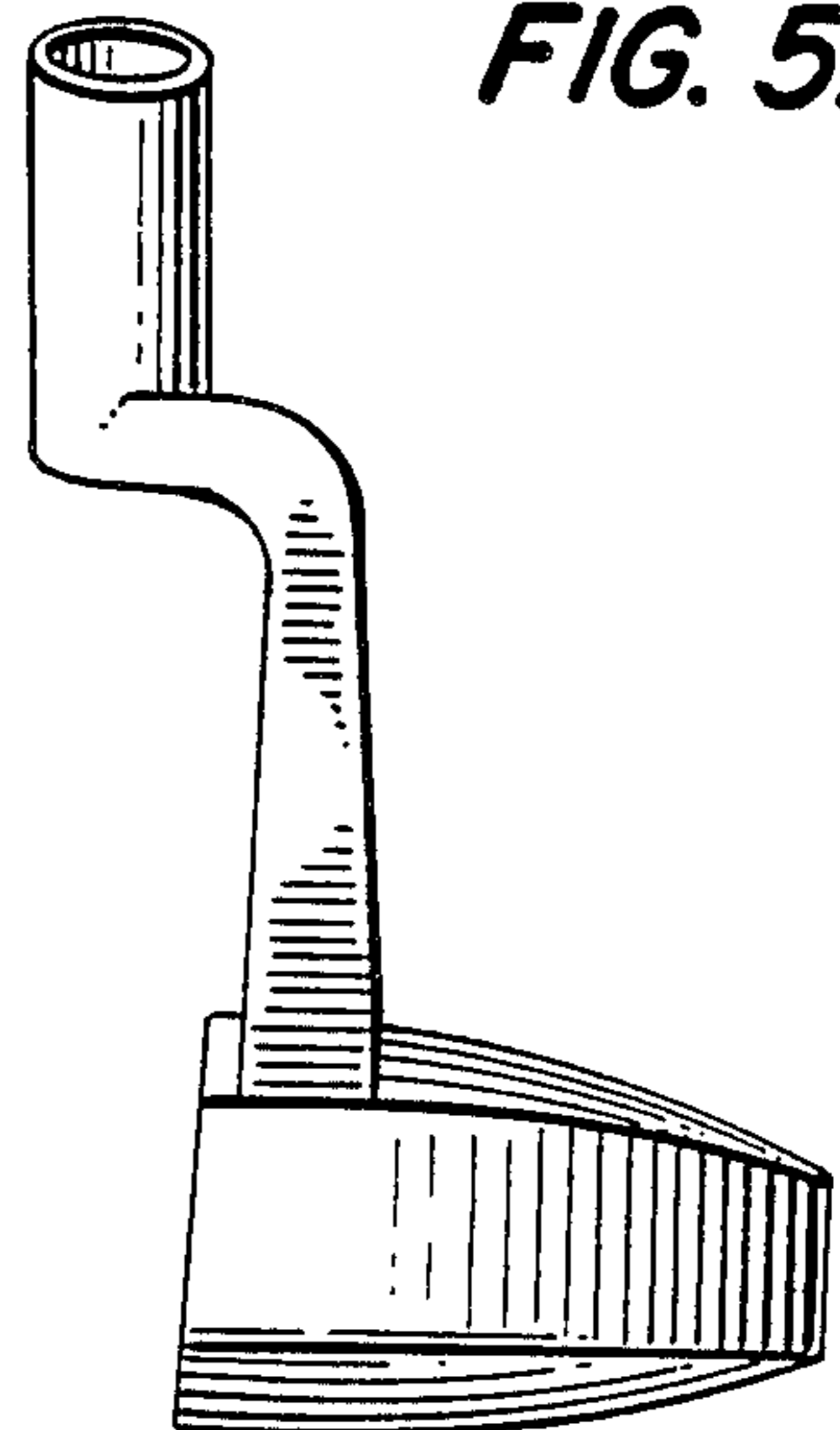

**FIG. 6.**

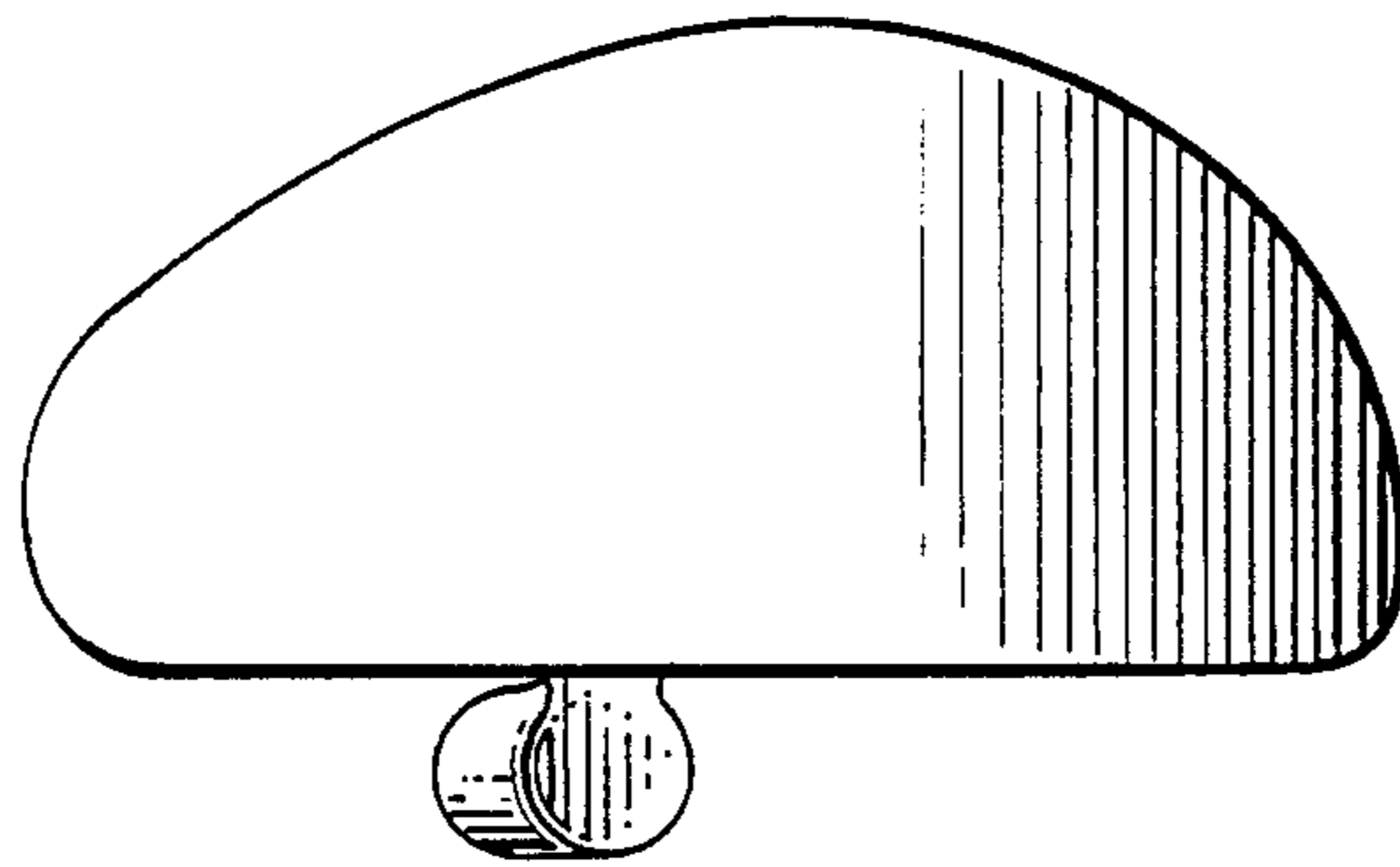

**FIG. 7.**

