

[54] AQUARIUM PUMP

[76] Inventor: Shian-Fun Tsai, 2 Fl., No. 20, Alley 7, Lane 23, Sec. 5, Nanking East Road, Taipei, Taiwan

[**] Term: 14 Years

[21] Appl. No.: 917,821

[22] Filed: Oct. 10, 1986

[52] U.S. Cl. D15/8

[58] Field of Search D15/7, 8, 9; 417/413, 417/424, 234, 236, 321, 572; 210/416.2

[56] References Cited

U.S. PATENT DOCUMENTS

- D. 224,356 7/1972 Kondo D15/8
- D. 253,652 12/1979 Maryanski D15/8
- 4,421,644 12/1983 Gedye 210/416.2 X
- 4,620,924 11/1986 Goldman et al. 210/416.2 X

Primary Examiner—Wallace R. Burke
Assistant Examiner—Brian N. Vinson
Attorney, Agent, or Firm—Asian Pacific International Patent and Trademark Office

[57] CLAIM

The ornamental design for an aquarium pump, as shown and described.

DESCRIPTION

FIG. 1 is a front elevational view of an aquarium pump, showing my new design;
FIG. 2 is a right side elevational view thereof;
FIG. 3 is a rear elevational view thereof;
FIG. 4 is a left side elevational view thereof;
FIG. 5 is a top plan view thereof;
FIG. 6 is a bottom plan view thereof; and,
FIG. 7 is a front, top and right side perspective view thereof.

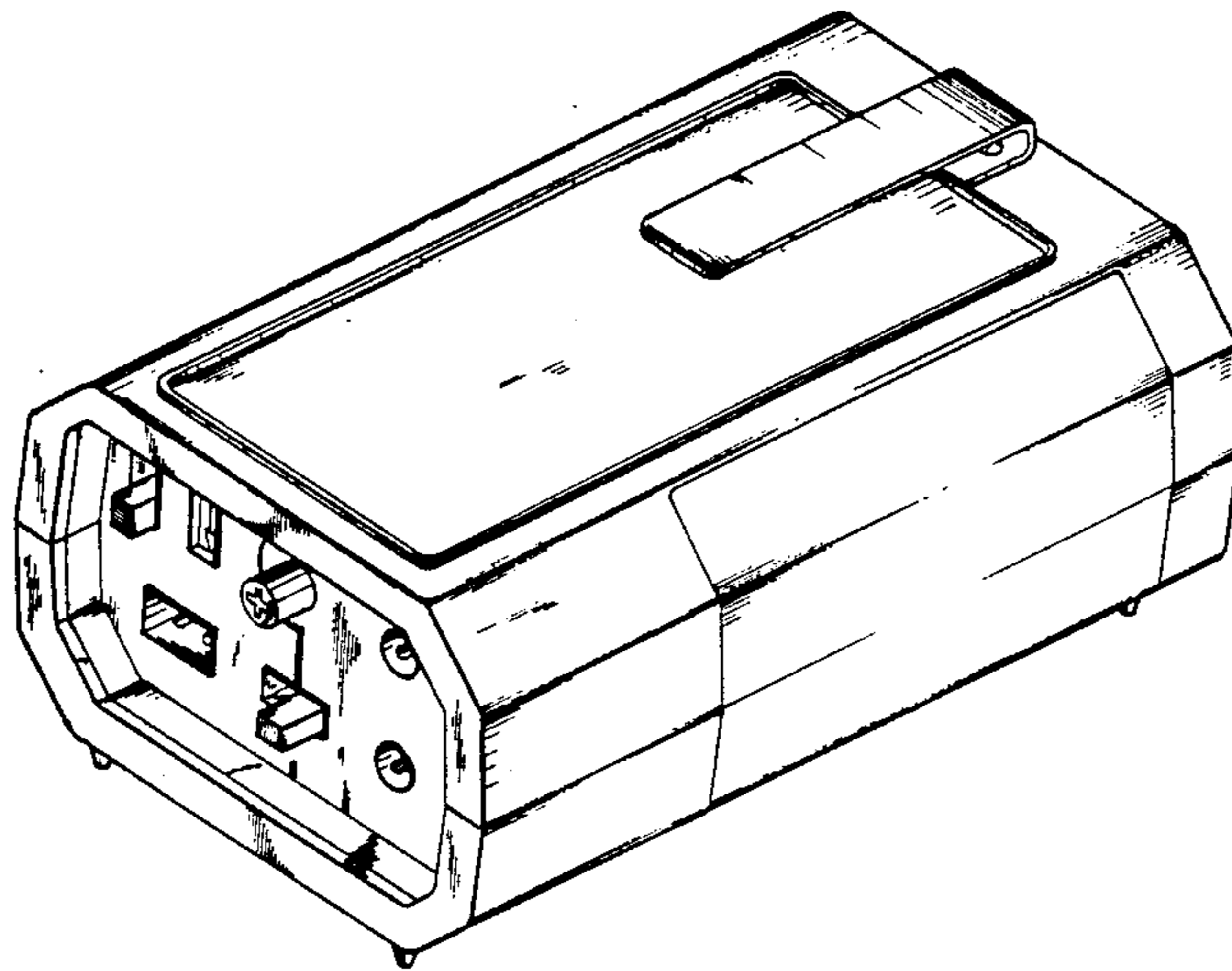

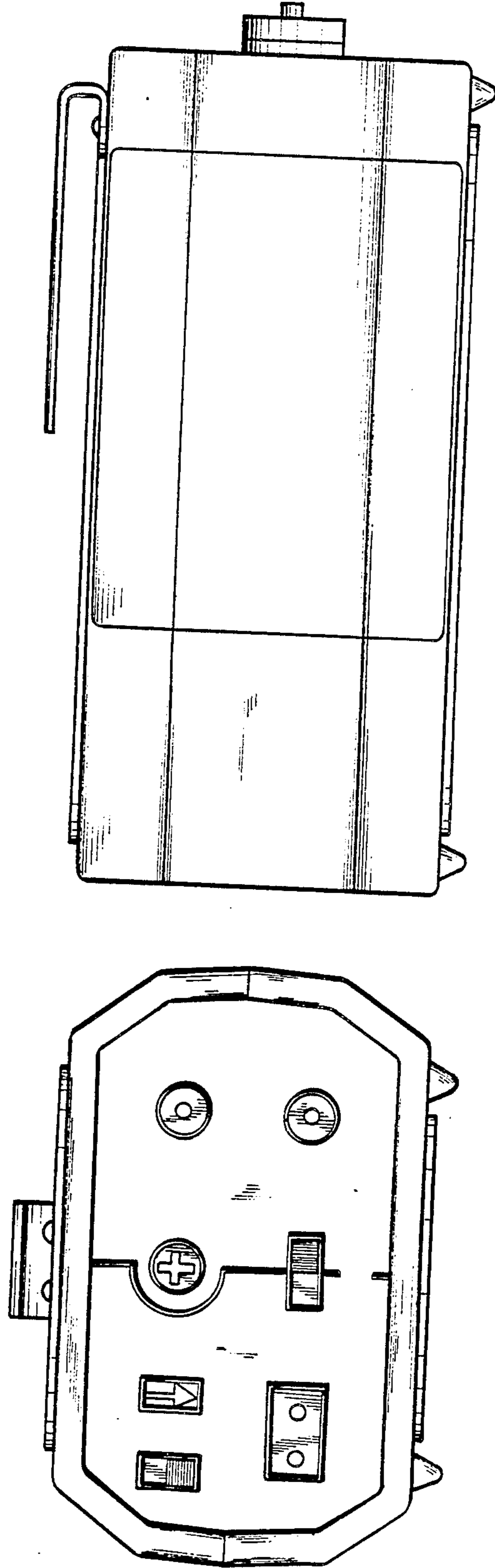

FIG. 2

FIG. 1

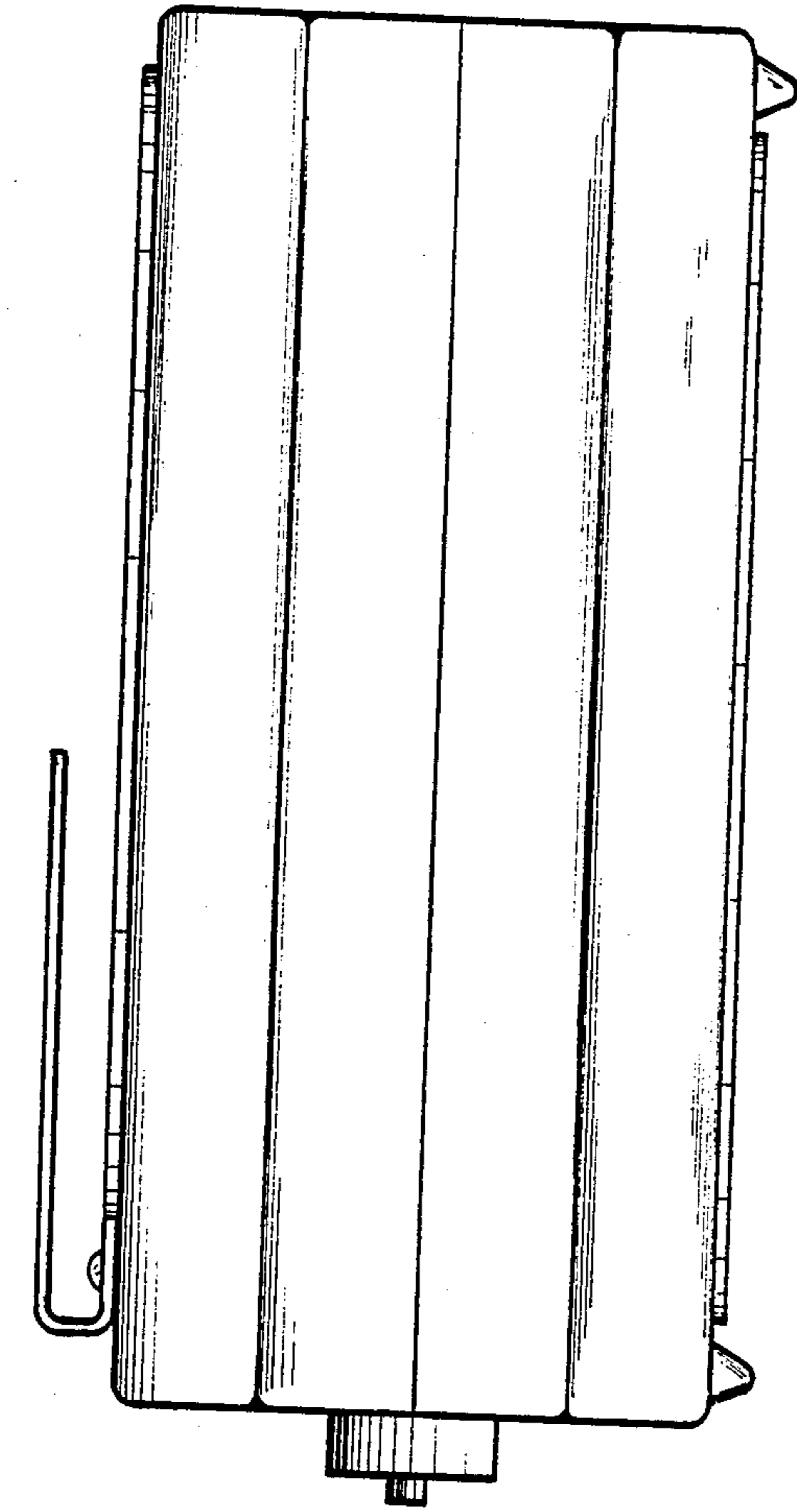

FIG. 3

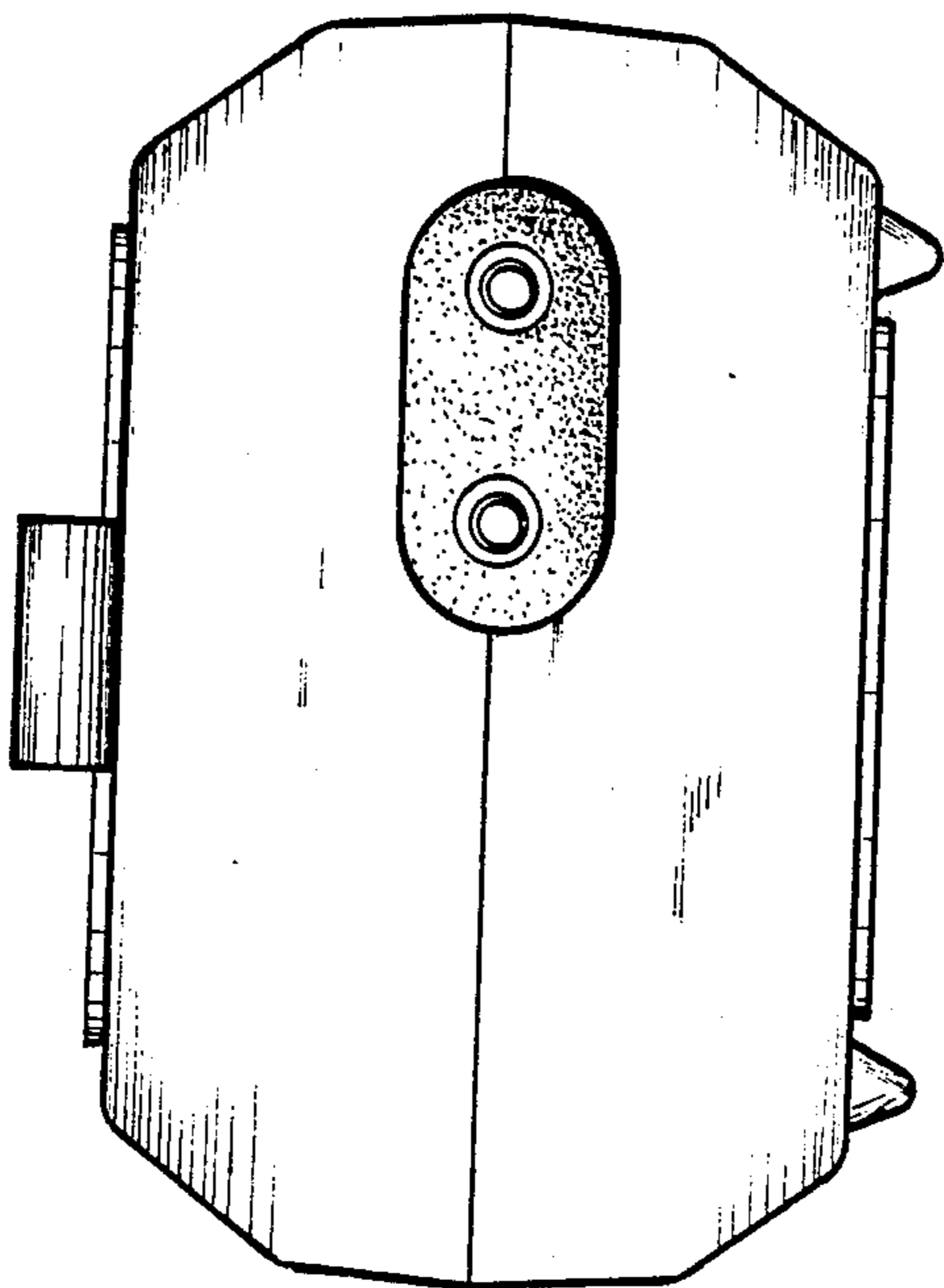

FIG. 4

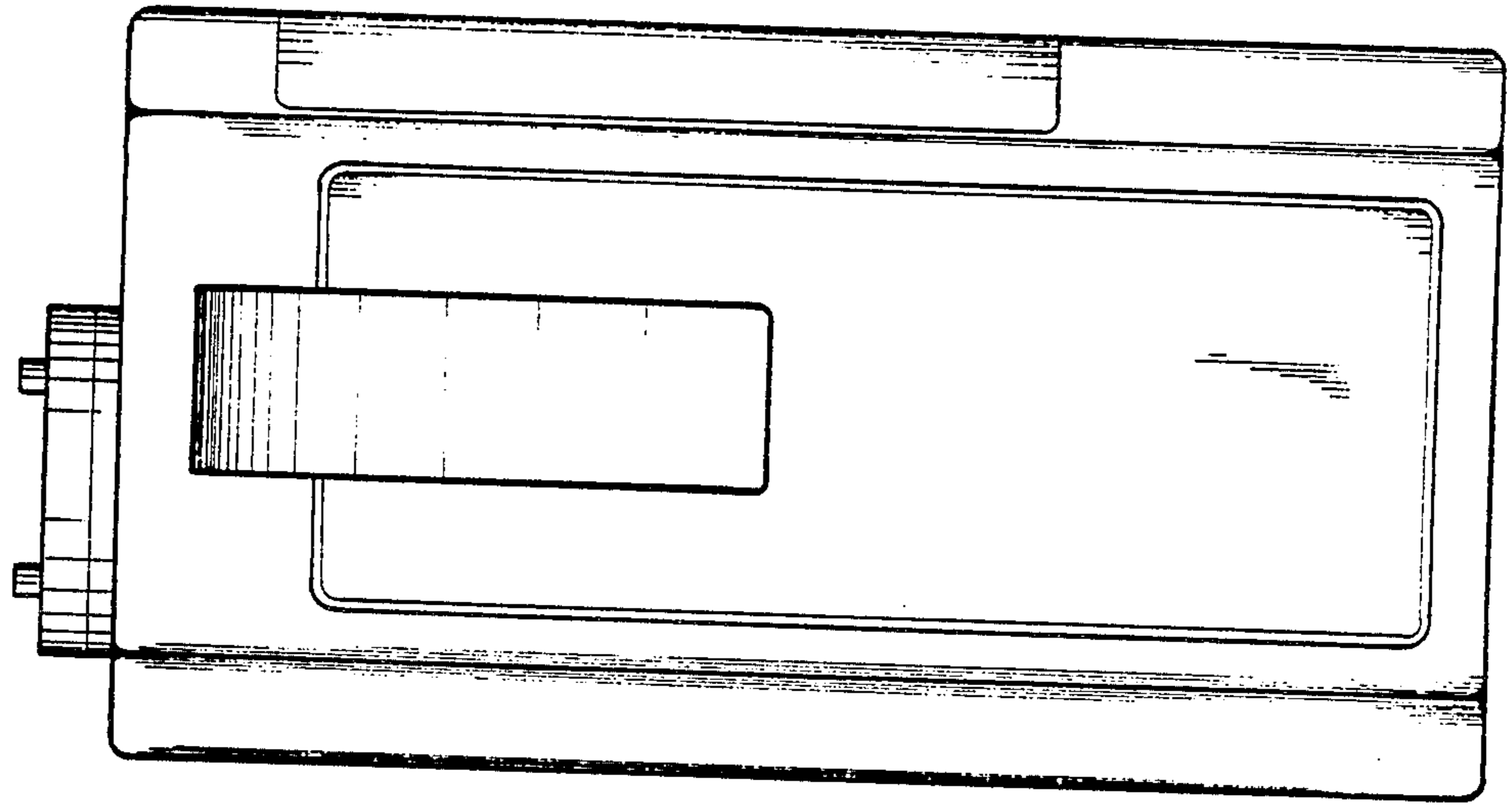

FIG. 6

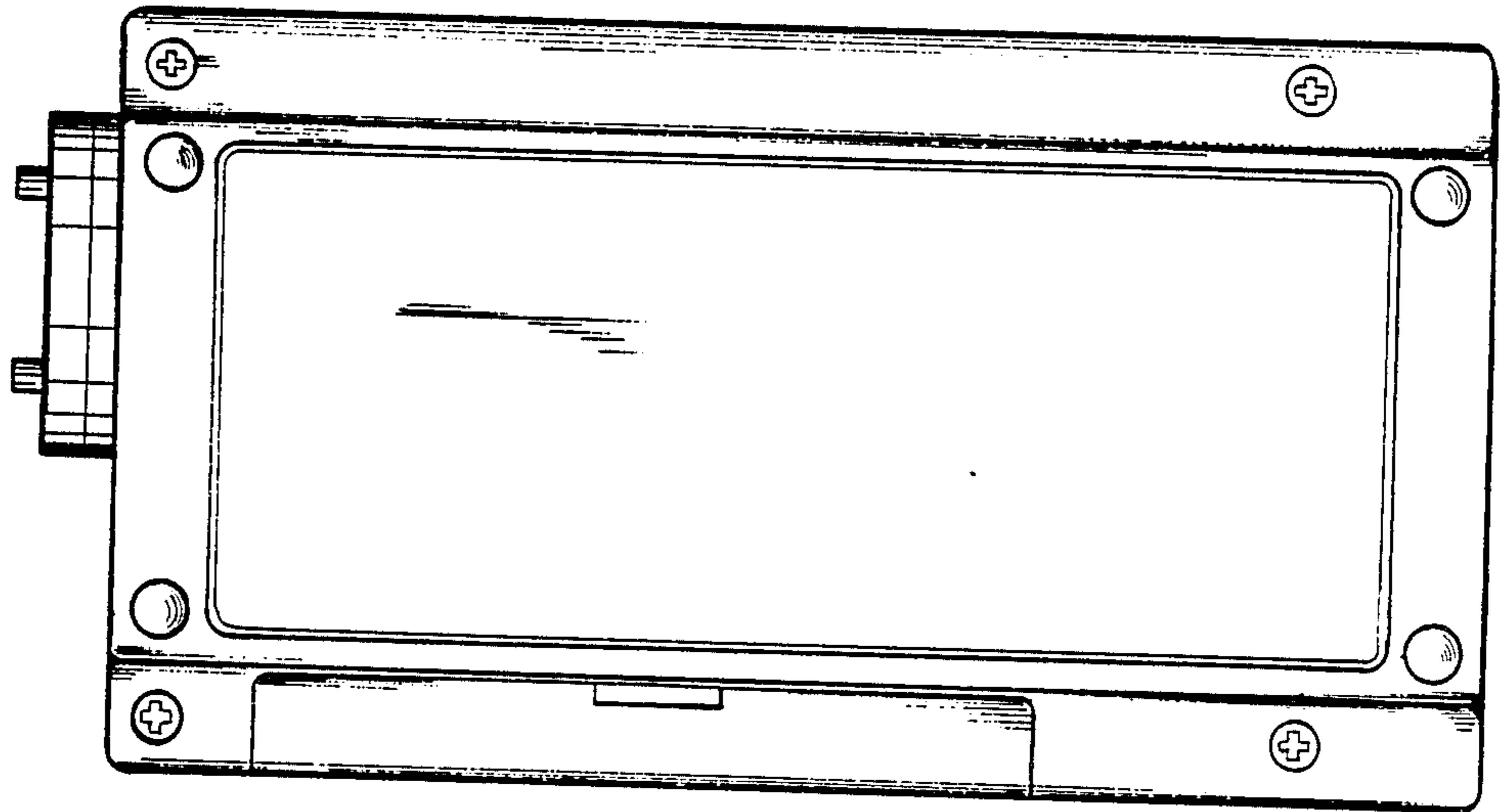

FIG. 5

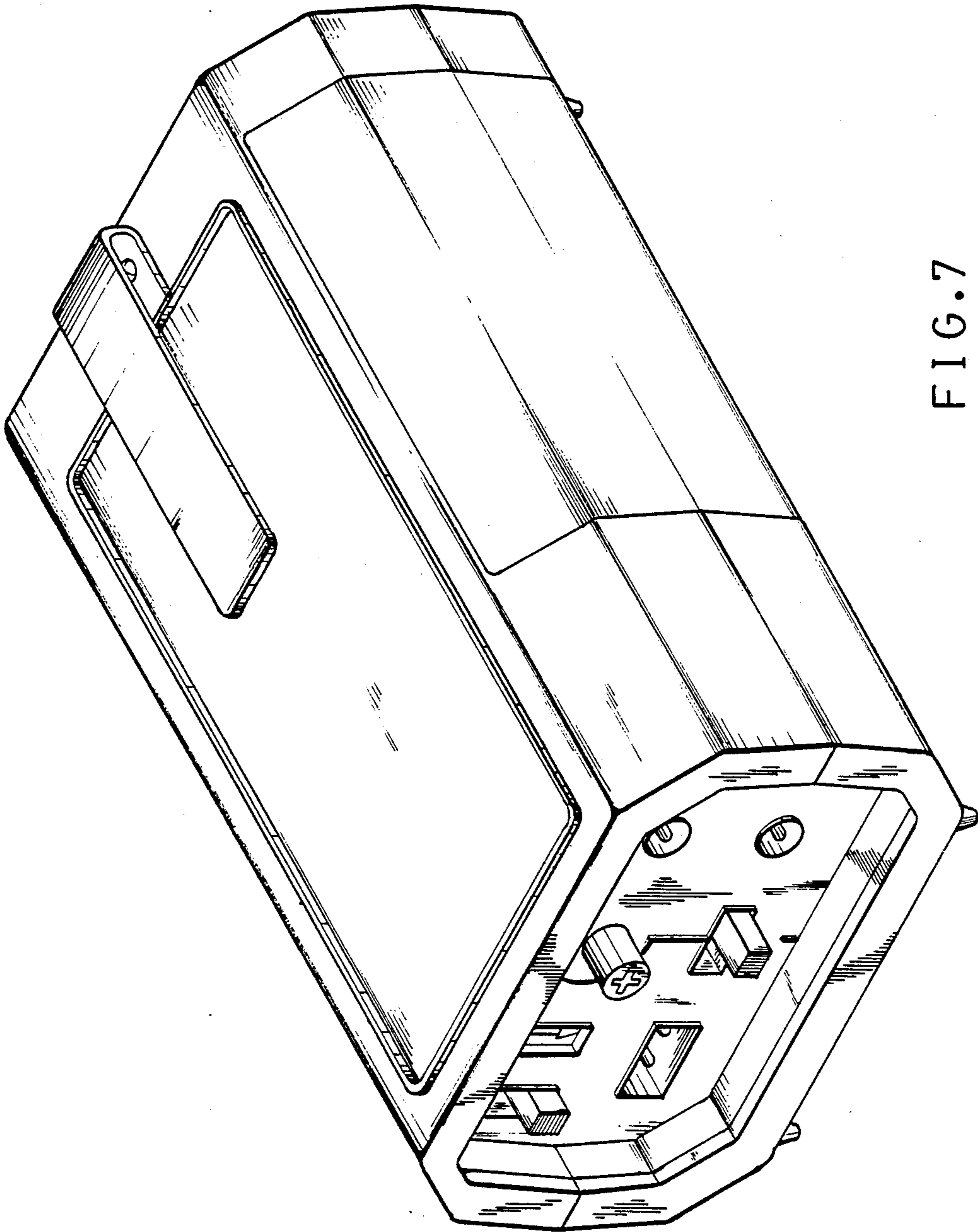

FIG. 7