

[54] **DISPLAY CASE**

[75] **Inventor: Herman Jakubowski, Spring Valley, N.Y.**

[73] **Assignee: Refcon, Inc., Congers, N.Y.**

[\*\*] **Term: 14 Years**

[21] **Appl. No.: 703,087**

[22] **Filed: Feb. 19, 1985**

[52] **U.S. Cl. .... D6/472**

[58] **Field of Search ..... D6/470, 471, 472;  
312/114, 116**

[56] **References Cited**

**U.S. PATENT DOCUMENTS**

- D. 168,288 12/1952 Cameron ..... D6/471
- D. 209,722 12/1967 Mangini ..... D6/472 X
- D. 268,069 3/1983 Milstein ..... D6/472

1,614,319 1/1927 Schmidt ..... 312/116

**FOREIGN PATENT DOCUMENTS**

2904873 8/1980 Fed. Rep. of Germany ..... 312/114

*Primary Examiner*—Carmen H. Vales

*Attorney, Agent, or Firm*—Schweitzer & Cornman

[57] **CLAIM**

The ornamental design for a display case, substantially as shown.

**DESCRIPTION**

FIG. 1 is a front elevational view of a display case showing my new design;

FIG. 2 is a rear elevational view thereof;

FIG. 3 is a left side elevational view thereof;

FIG. 4 is a right side elevational view thereof;

FIG. 5 is a top plan view thereof;

FIG. 6 is a bottom plan view thereof; and

FIG. 7 is a perspective view thereof.

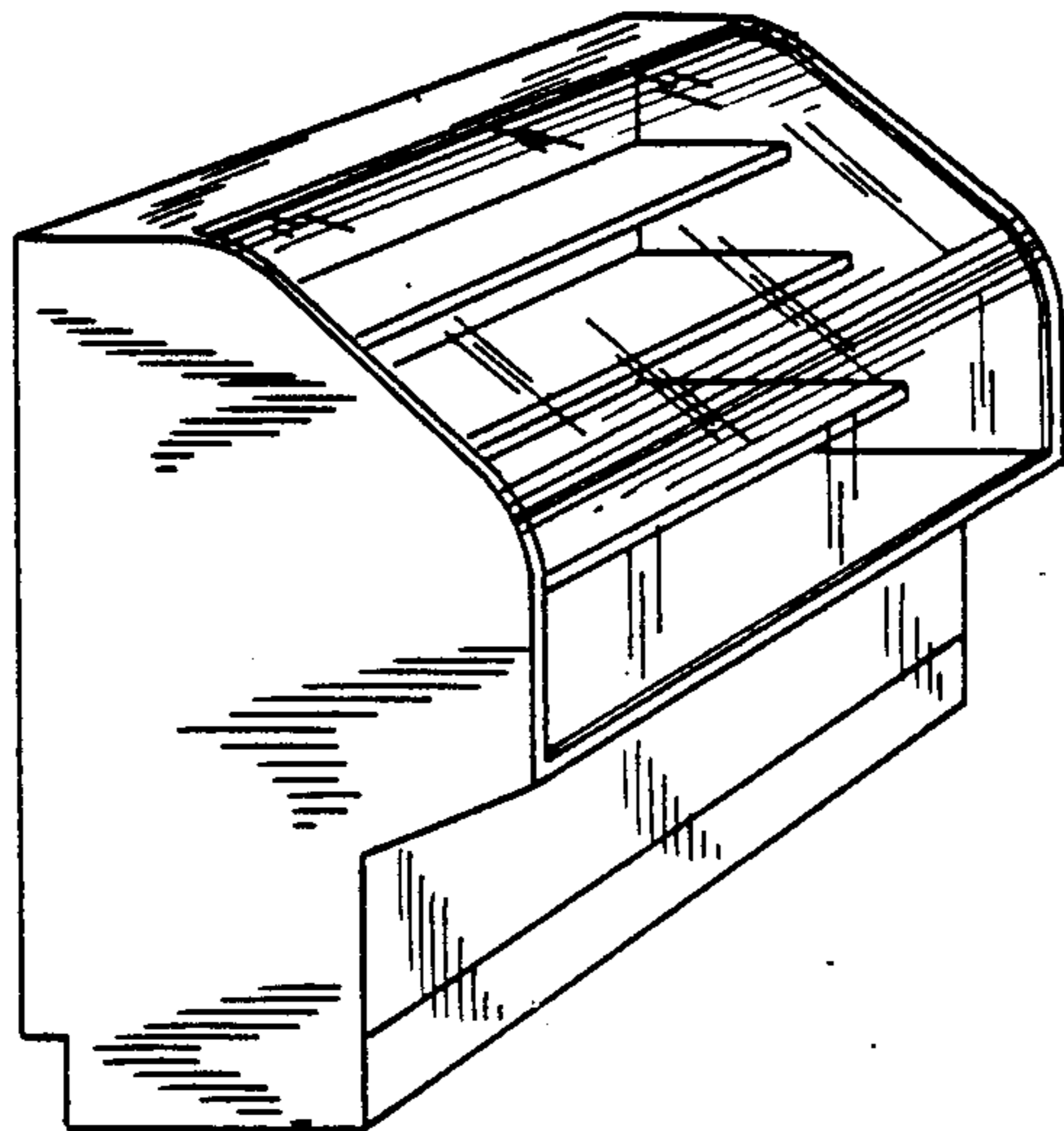

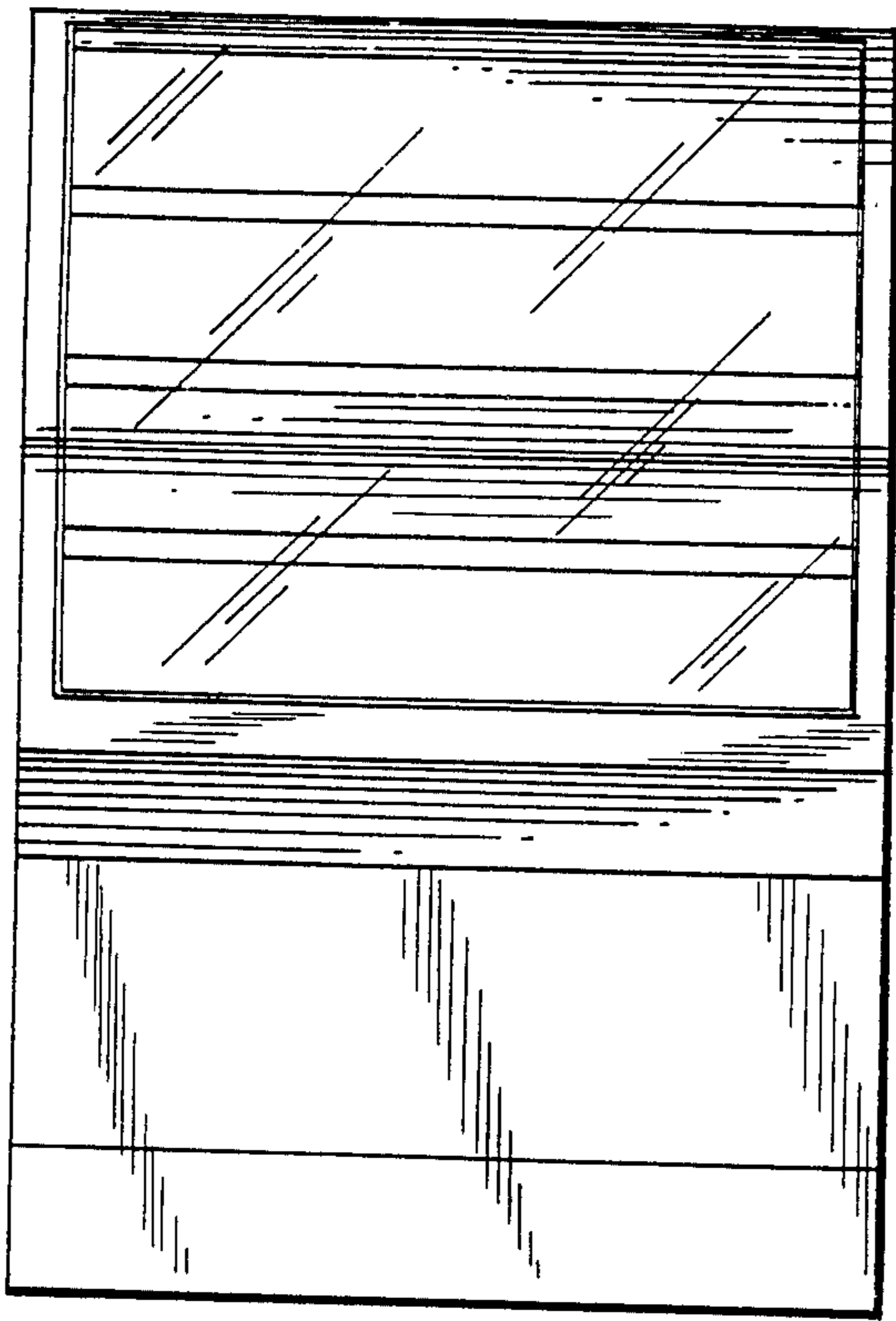

FIG. 1

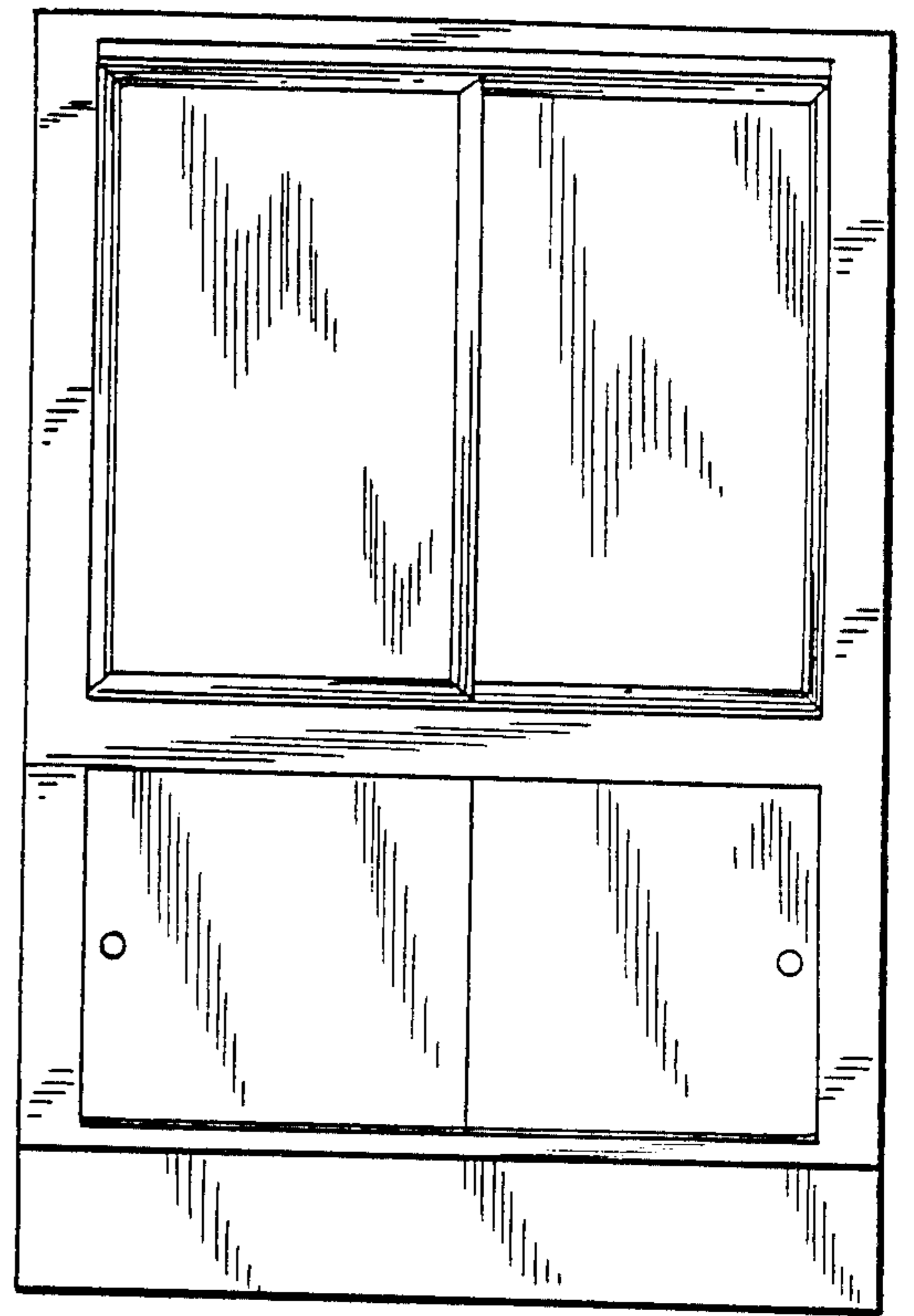

FIG. 2

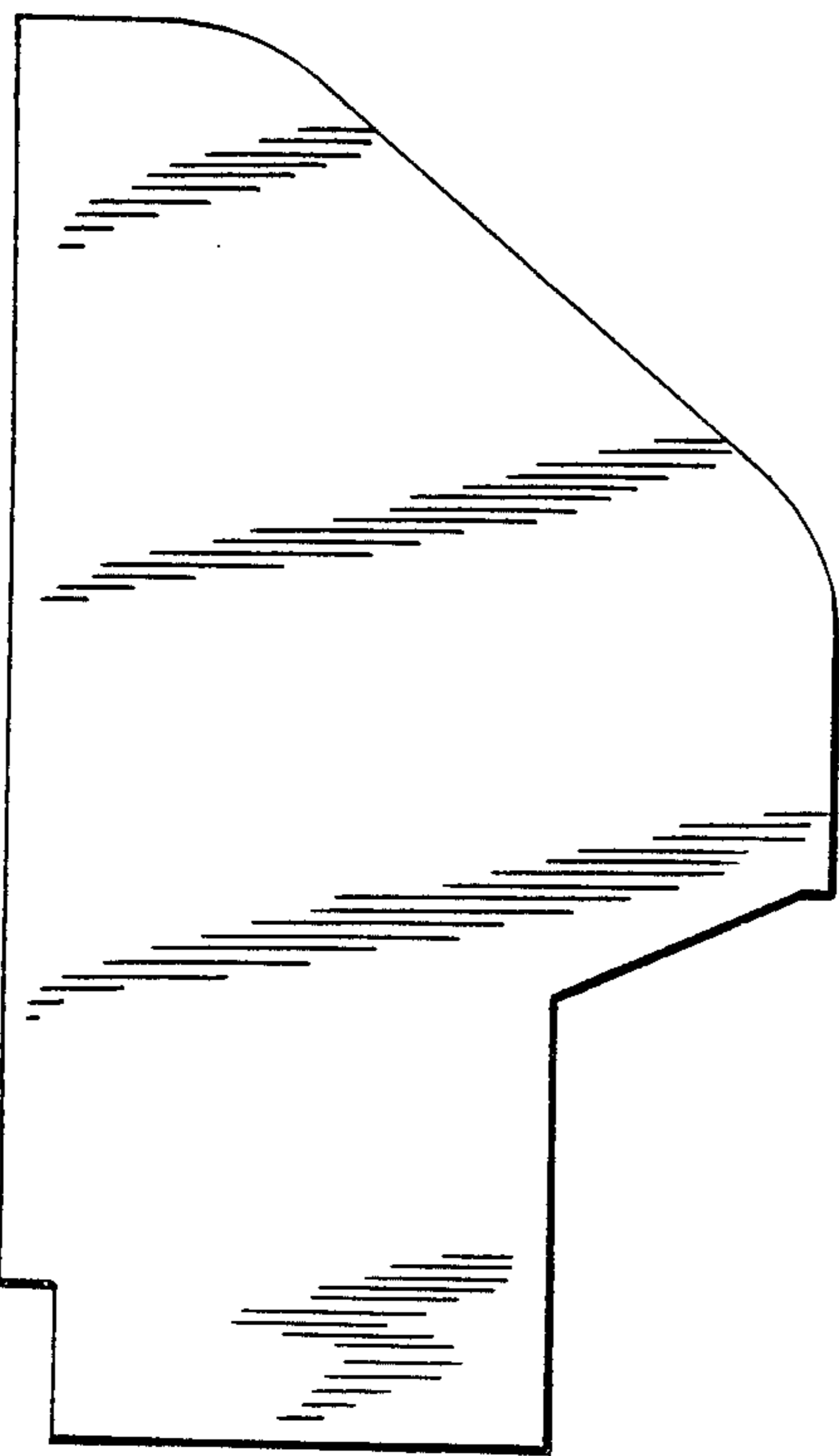

FIG. 3

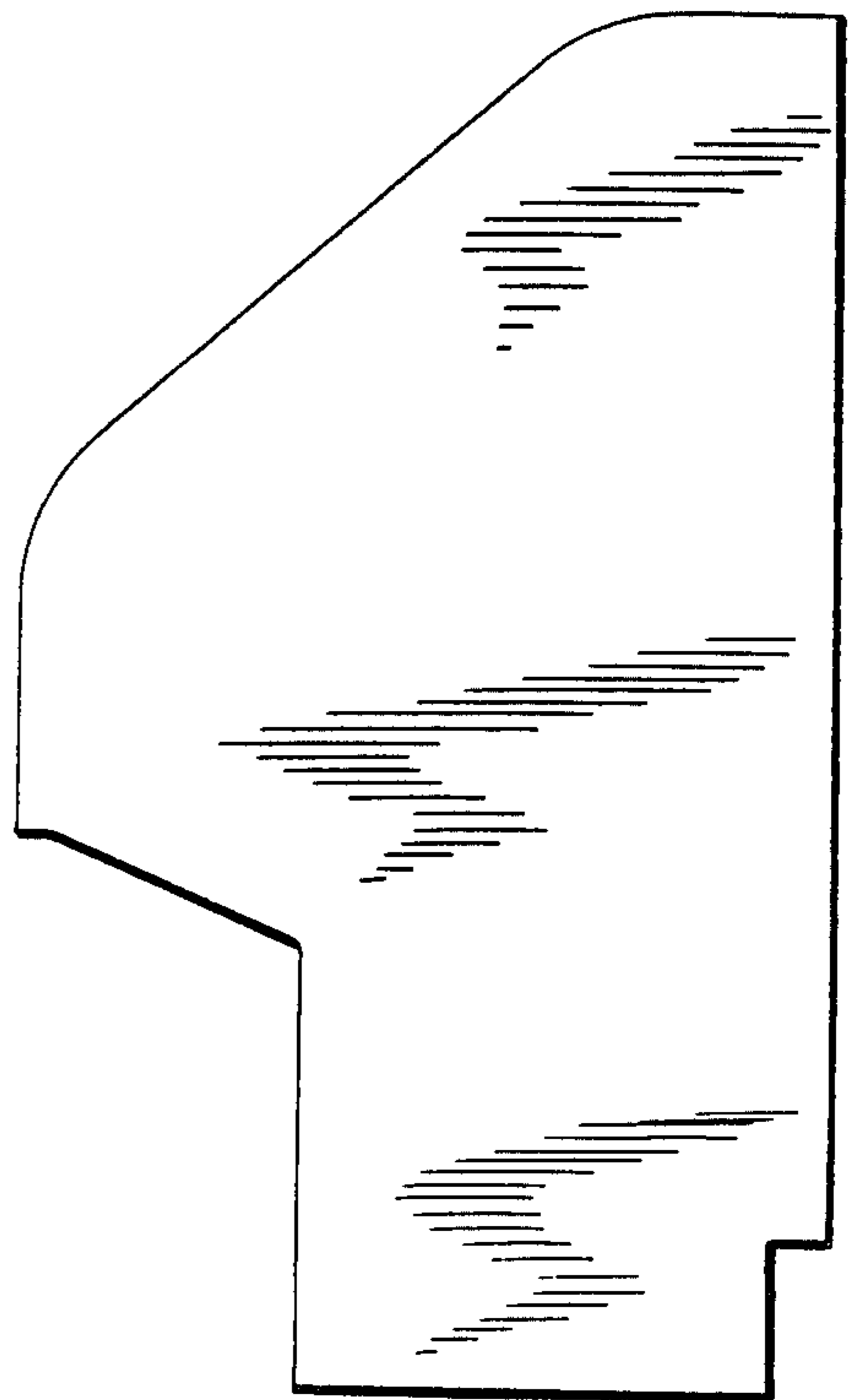

FIG. 4

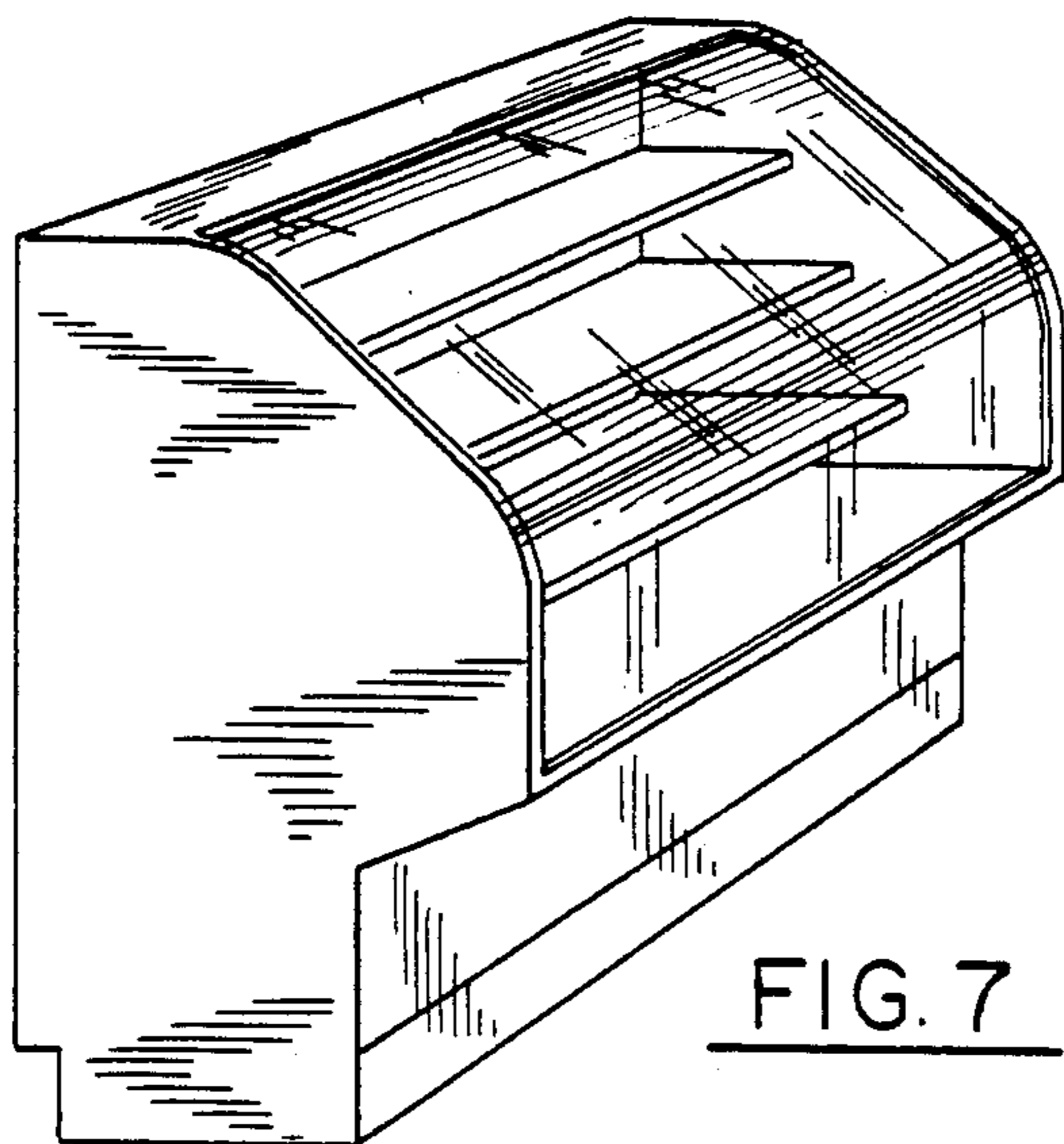

FIG. 7

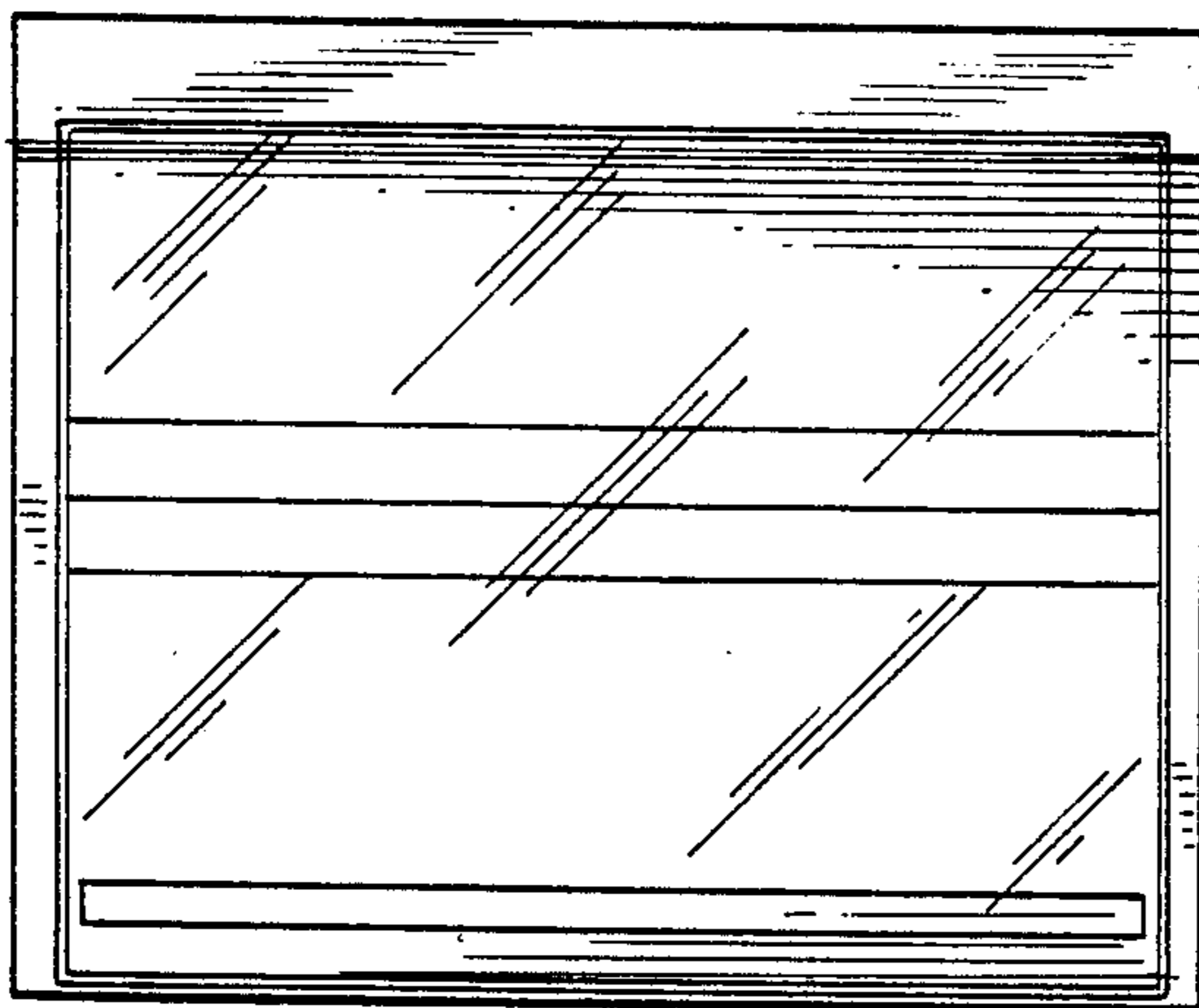

FIG. 5

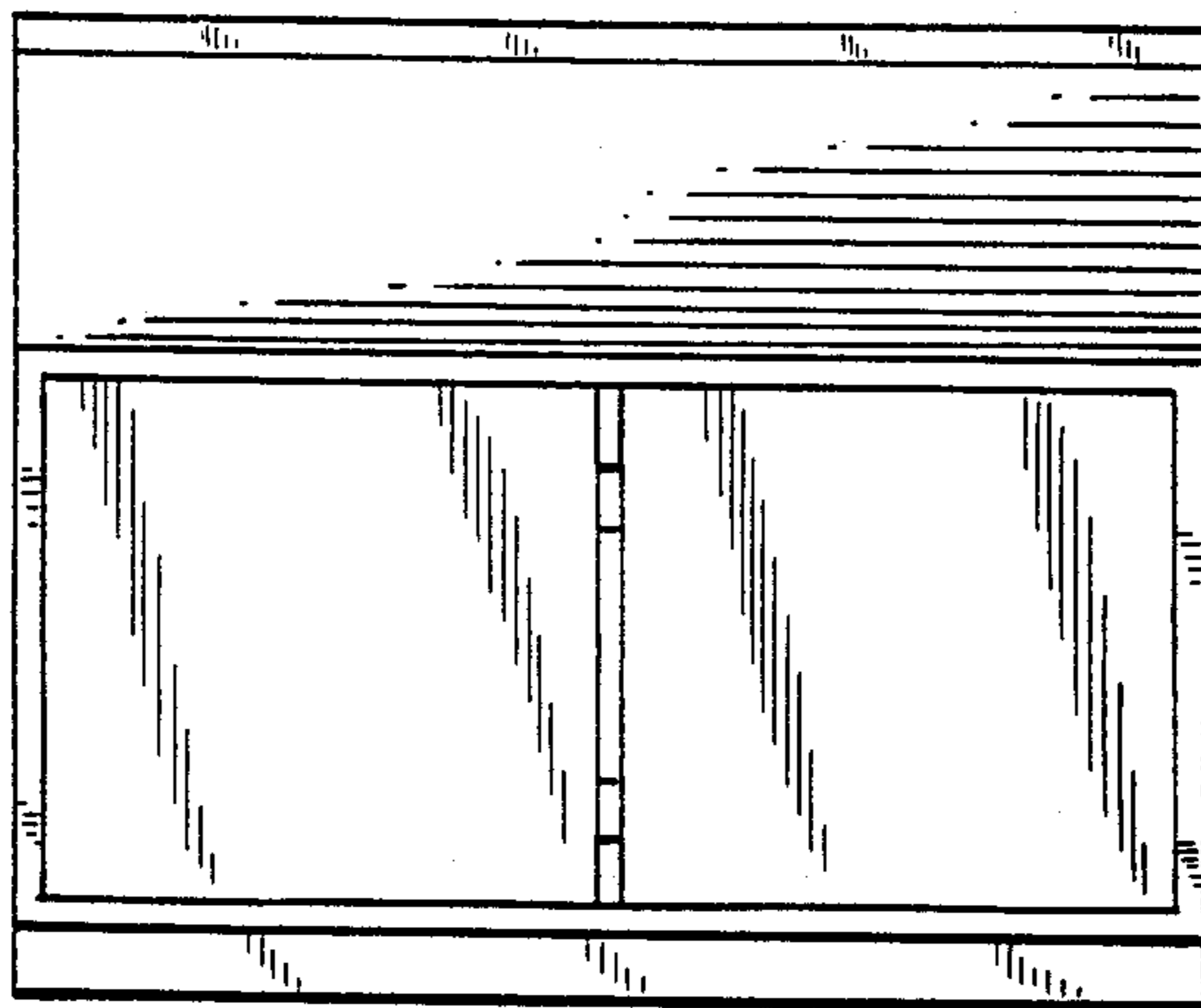

FIG. 6