

[54] BRACKET FOR A BATHROOM ACCESSORY

[75] Inventor: Raymond U. H. Tegner, Lodi, Wis.

[73] Assignee: Amerock Corporation, Rockford, Ill.

[\*\*] Term: 14 Years

[21] Appl. No.: 791,908

[22] Filed: Oct. 28, 1985

[52] U.S. Cl. .... D6/524; D6/531; D6/540; D8/373

[58] Field of Search ..... D6/524, 527, 529, 531, D6/532, 534, 535, 536, 540; D8/373, 353; 211/13, 65, 87, 88, 75; 248/309.1, 359 R, 359 A, 360, 359.1, 309.1, 311.2, 315

[56] References Cited

U.S. PATENT DOCUMENTS

- D. 228,842 10/1973 Tegner .
- D. 231,166 4/1974 Tegner ..... D6/536
- D. 234,173 1/1978 Tegner .

- D. 237,044 10/1975 Mori ..... D8/353
- D. 238,734 2/1976 Read et al. .... D6/540
- D. 261,959 11/1981 Shames et al. .... D6/524

Primary Examiner—B. J. Bullock  
Attorney, Agent, or Firm—Leydig, Voit & Mayer

[57] CLAIM

The ornamental design for a bracket for a bathroom accessory, as shown and described.

DESCRIPTION

FIG. 1 is a top view of a bracket for a bathroom accessory, showing my new design;  
 FIG. 2 is a side view as seen from the bottom of FIG. 1.  
 FIG. 3 is an end view as seen from the right of FIG. 1.  
 FIG. 4 is a sectional view taken in the direction of the arrows on line 4—4 of FIG. 1;  
 FIG. 5 is a sectional view taken in the direction of the arrows on line 5—5 of FIG. 1;  
 FIG. 6 is a fragmentary sectional view taken in the direction of the arrows on line 6—6 of FIG. 5.

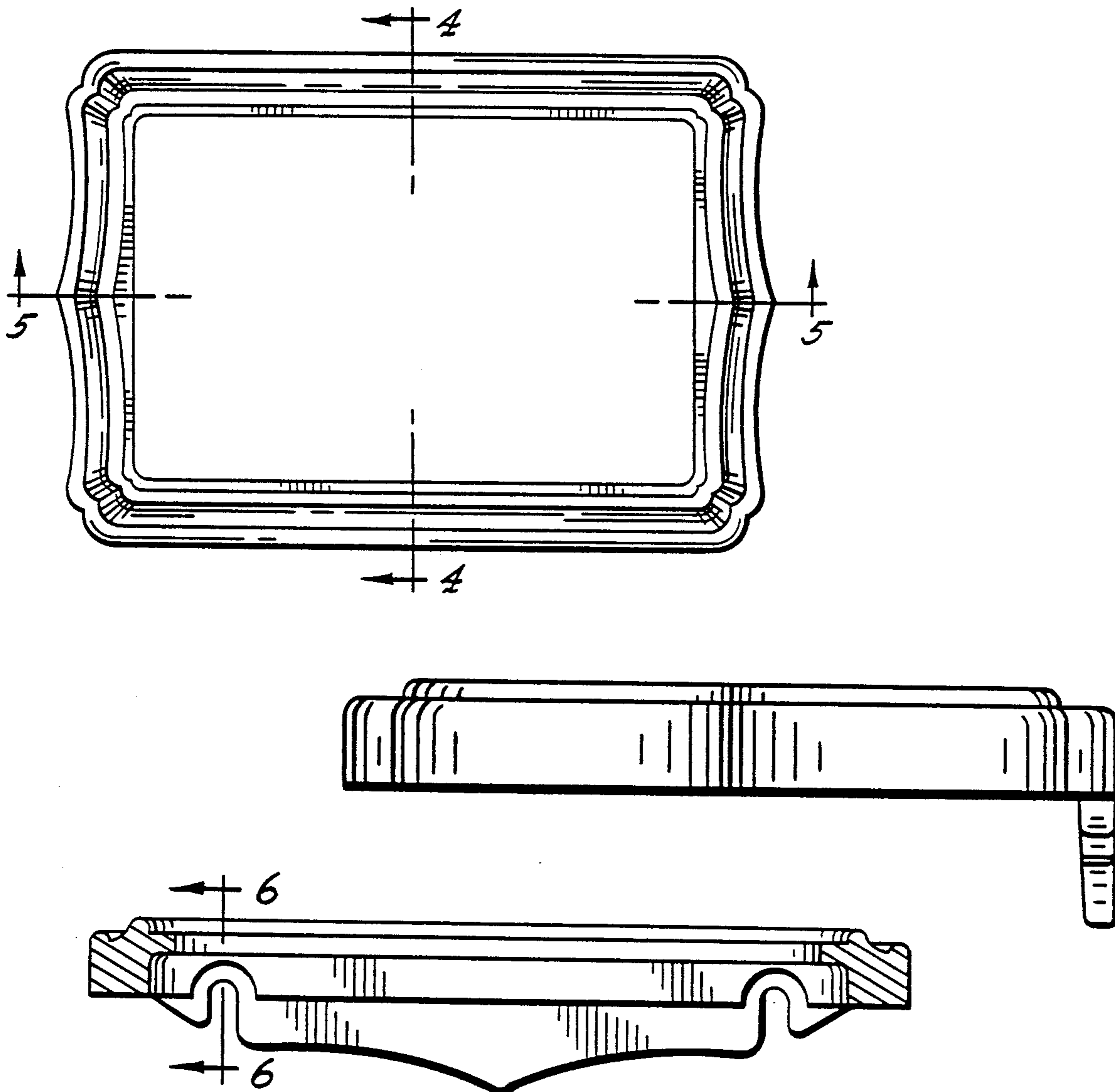

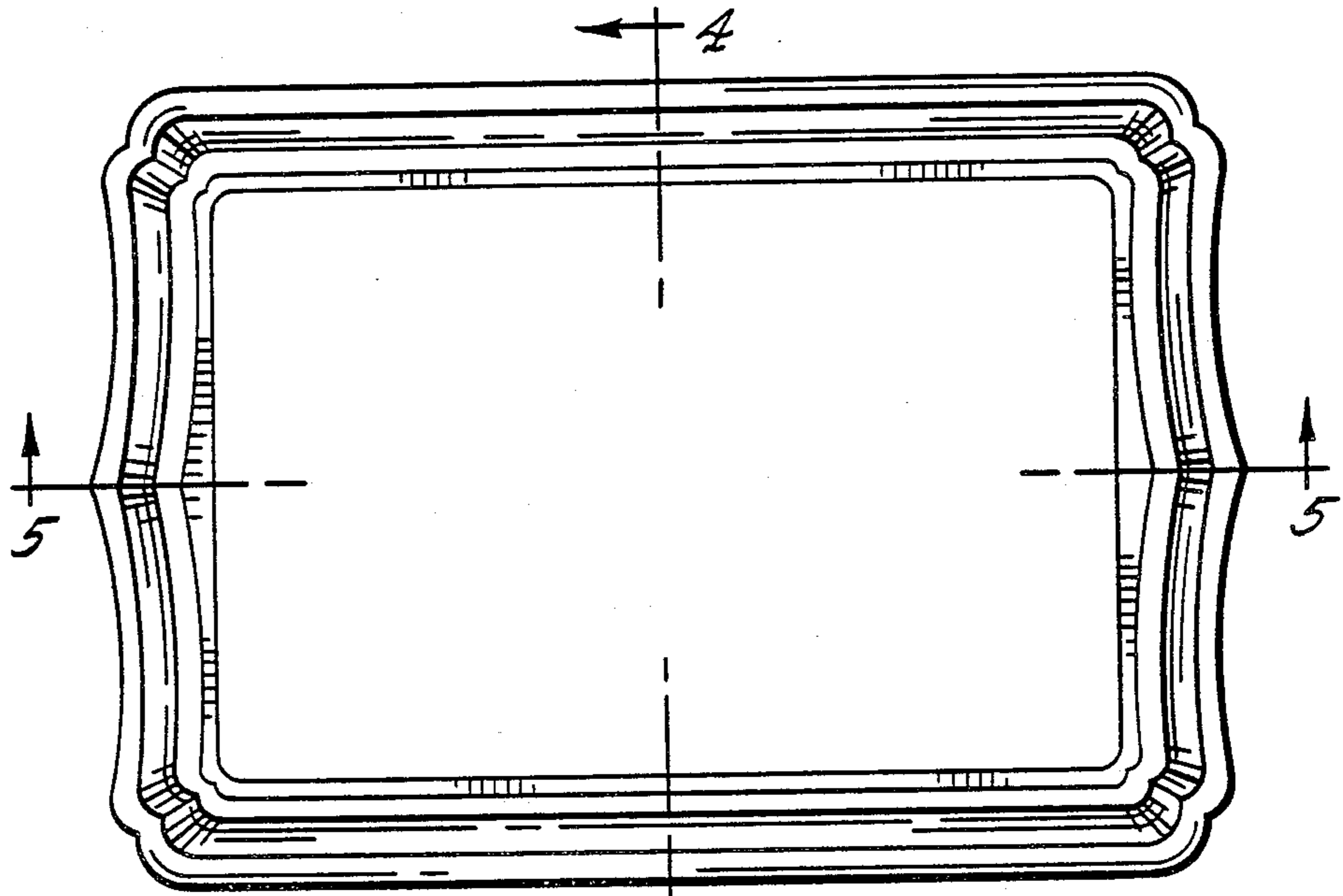

FIG. 1.

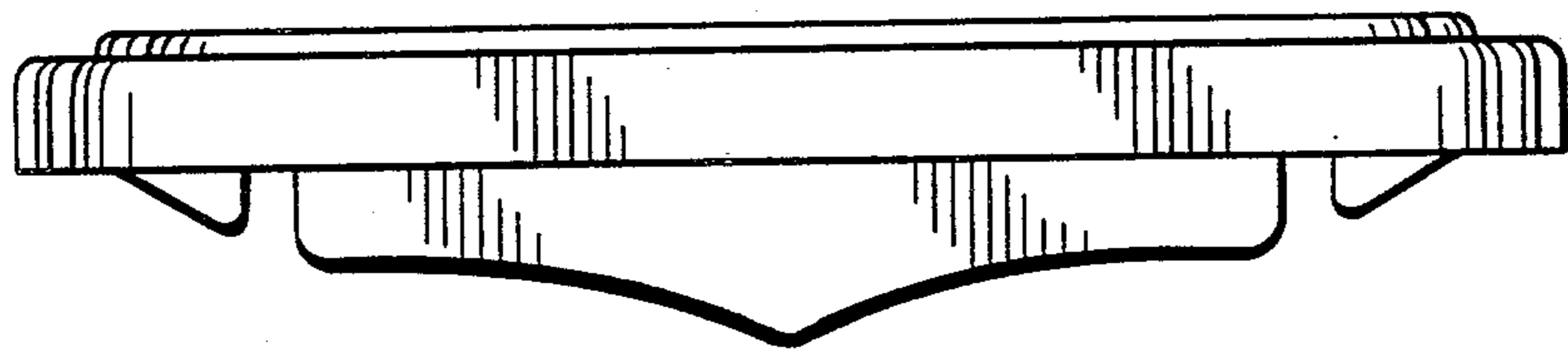

FIG. 2.

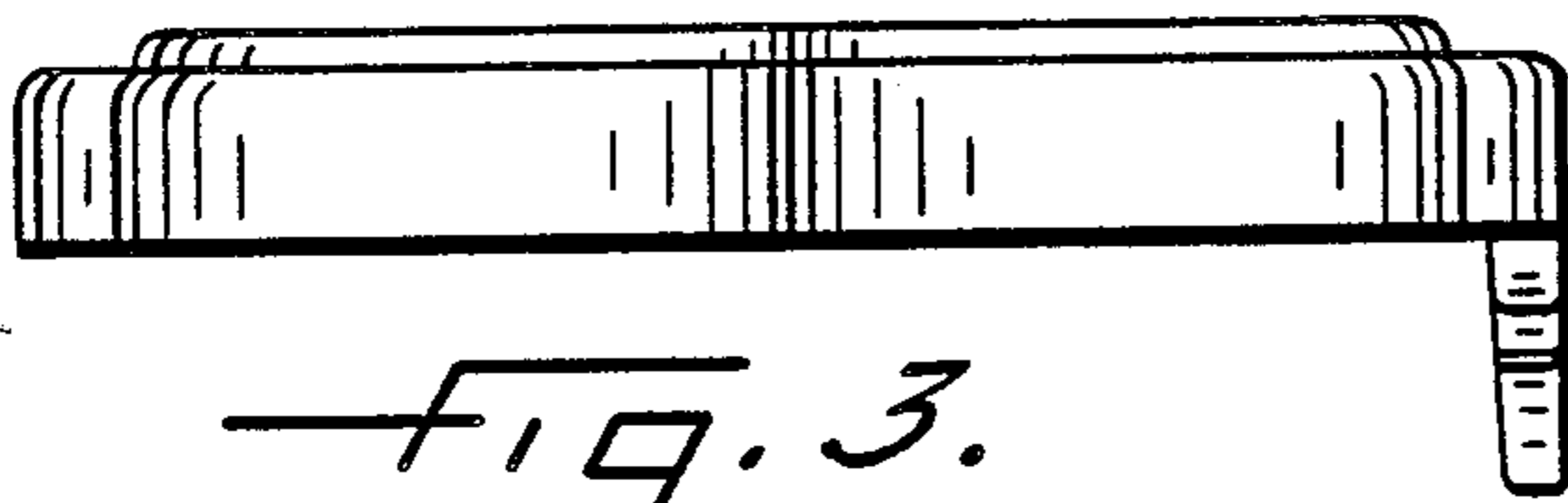

FIG. 3.

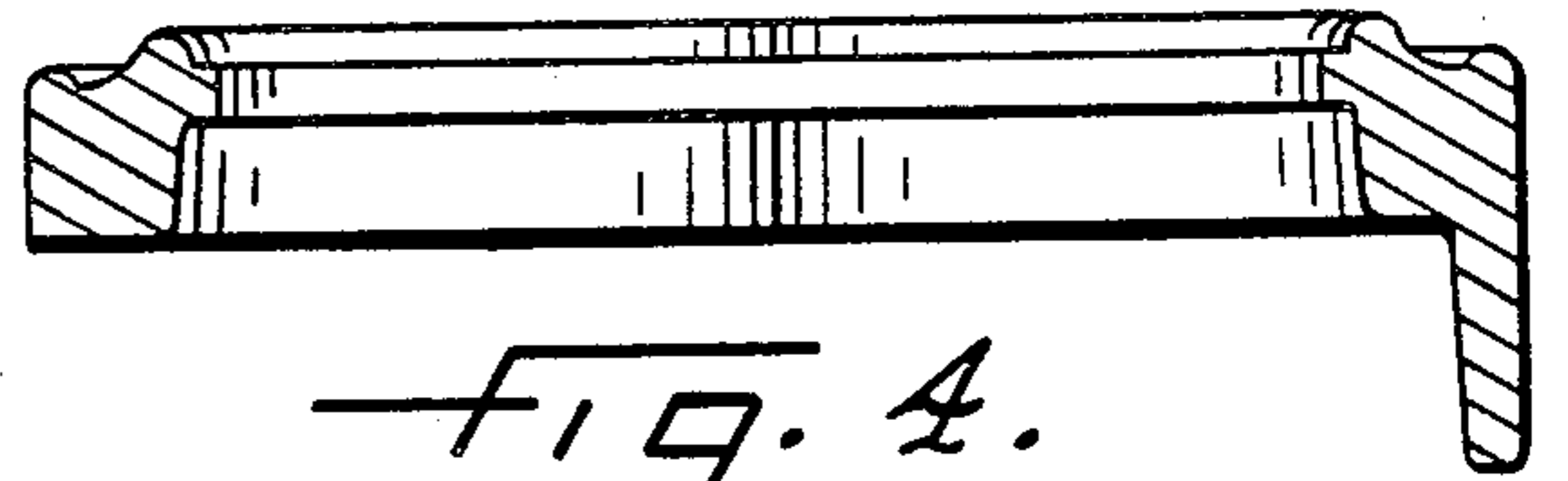

FIG. 4.

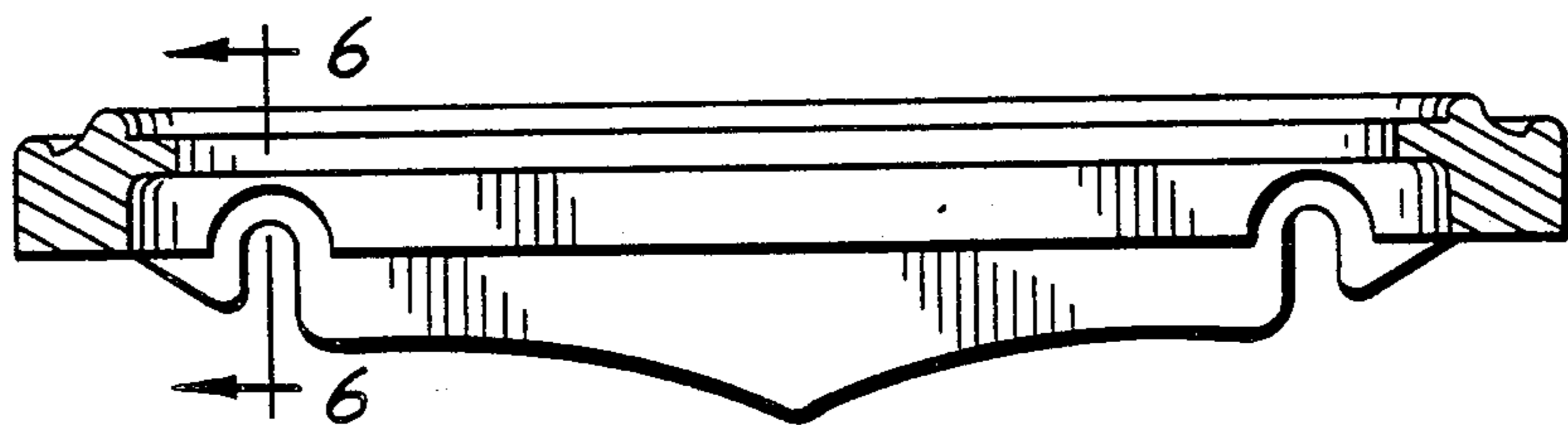

FIG. 5.

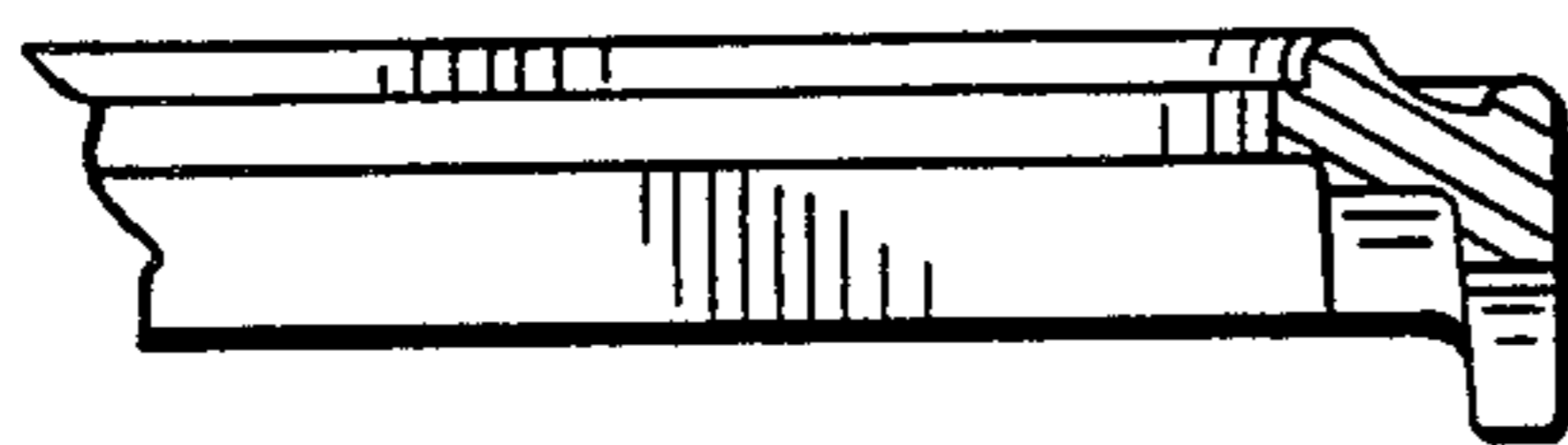

FIG. 6.