

[54] DISPLAY STAND

[75] Inventor: O. Timothy White, Carnesville, Ga.

[73] Assignee: Royston Corporation, Royston, Ga.

[\*\*] Term: 14 Years

[21] Appl. No.: 730,859

[22] Filed: May 6, 1985

[52] U.S. Cl. .... D6/455

[58] Field of Search ..... D6/329, 396, 442, 455,  
D6/486; D20/10, 16, 17, 21, 41

[56] References Cited

U.S. PATENT DOCUMENTS

D. 10,341	12/1877	Luchs .....	D6/442
D. 37,304	1/1905	Palmer .....	D6/455
D. 42,076	1/1912	Van Diver .....	D6/455 X
D. 47,821	9/1915	Huskey .....	D6/455
D. 65,640	9/1924	Duff et al. ....	D6/455
D. 71,560	11/1926	Nash .....	D6/455
D. 106,502	10/1937	Fine .	
D. 109,166	4/1938	Tilton et al. .	
D. 133,434	8/1942	Graham .....	D6/486 X
236,860	9/1975	Berger .....	D6/455
275,969	10/1984	Bowers .....	D20/10 X
275,970	10/1984	Bowers .....	D20/41 X
2,372,387	3/1945	Morin, Jr. et al. ....	40/145
3,517,905	6/1970	Nestegard .....	248/469
3,952,437	4/1976	Mitchell .....	40/152.1

Primary Examiner—Carmen H. Vales

Attorney, Agent, or Firm—Howson and Howson

[57] CLAIM

The ornamental design for a display stand, as shown and described.

DESCRIPTION

FIG. 1 is a perspective view of a display stand showing my new design;

FIG. 2 is a top plan view thereof;

FIG. 3 is a bottom plan view thereof;

FIG. 4 is a front elevational view thereof;

FIG. 5 is a right side elevational view of FIG. 4;

FIG. 6 is a sectional view taken along line 6—6 of FIG. 4;

FIG. 7 is a sectional view taken along line 7—7 of FIG. 4;

FIG. 8 is a top plan view of a second embodiment of a display stand in accordance with my new design;

FIG. 9 is a bottom plan view thereof;

FIG. 10 is a front elevational view thereof;

FIG. 11 is a right side elevational view of FIG. 10;

FIG. 12 is a sectional view taken along line 12—12 of FIG. 10;

FIG. 13 is a sectional view taken along line 13—13 of FIG. 10;

FIG. 14 is a top plan view of a third embodiment of a display stand in accordance with my new design;

FIG. 15 is a bottom plan view thereof;

FIG. 16 is a front elevational view thereof;

FIG. 17 is a right side elevational view of FIG. 16;

FIG. 18 is a sectional view taken along line 18—18 of FIG. 16;

FIG. 19 is a sectional view taken along line 19—19 of FIG. 16;

FIG. 20 is a top plan view of a fourth embodiment of a display stand in accordance with my new design;

FIG. 21 is a bottom plan view thereof;

FIG. 22 is a front elevational view thereof;

FIG. 23 is a right side elevational view of FIG. 22;

FIG. 24 is a sectional view taken along line 24—24 of FIG. 22;

FIG. 25 is a sectional view taken along line 25—25 of FIG. 22;

FIG. 26 is a top plan view of a fifth embodiment of a display stand in accordance with my new design;

FIG. 27 is a bottom plan view thereof;

FIG. 28 is a front elevational view thereof;

FIG. 29 is a right side elevational view of FIG. 28;

FIG. 30 is a sectional view taken along line 30—30 of FIG. 28;

FIG. 31 is a sectional view taken along line 31—31 of FIG. 28;

FIG. 32 is a top plan view of a sixth embodiment of a display stand in accordance with my new design;

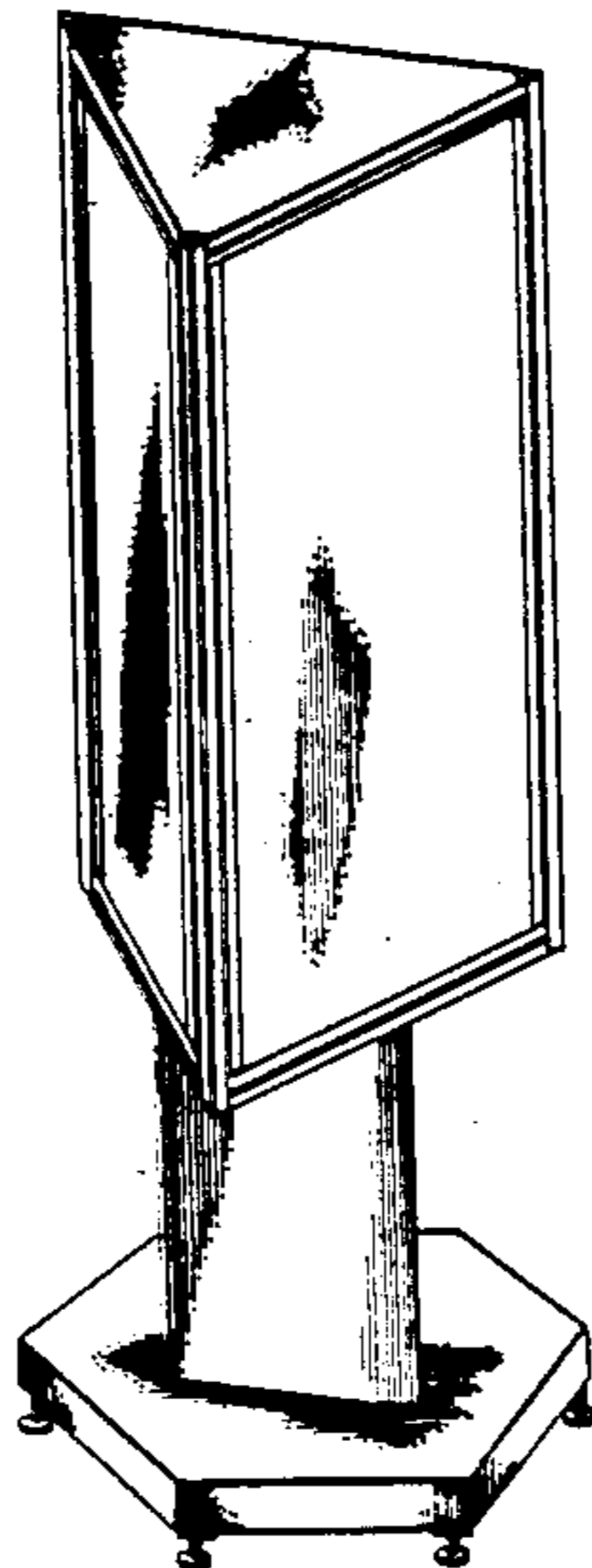
FIG. 33 is a bottom plan view thereof;

FIG. 34 is a front elevational view thereof;

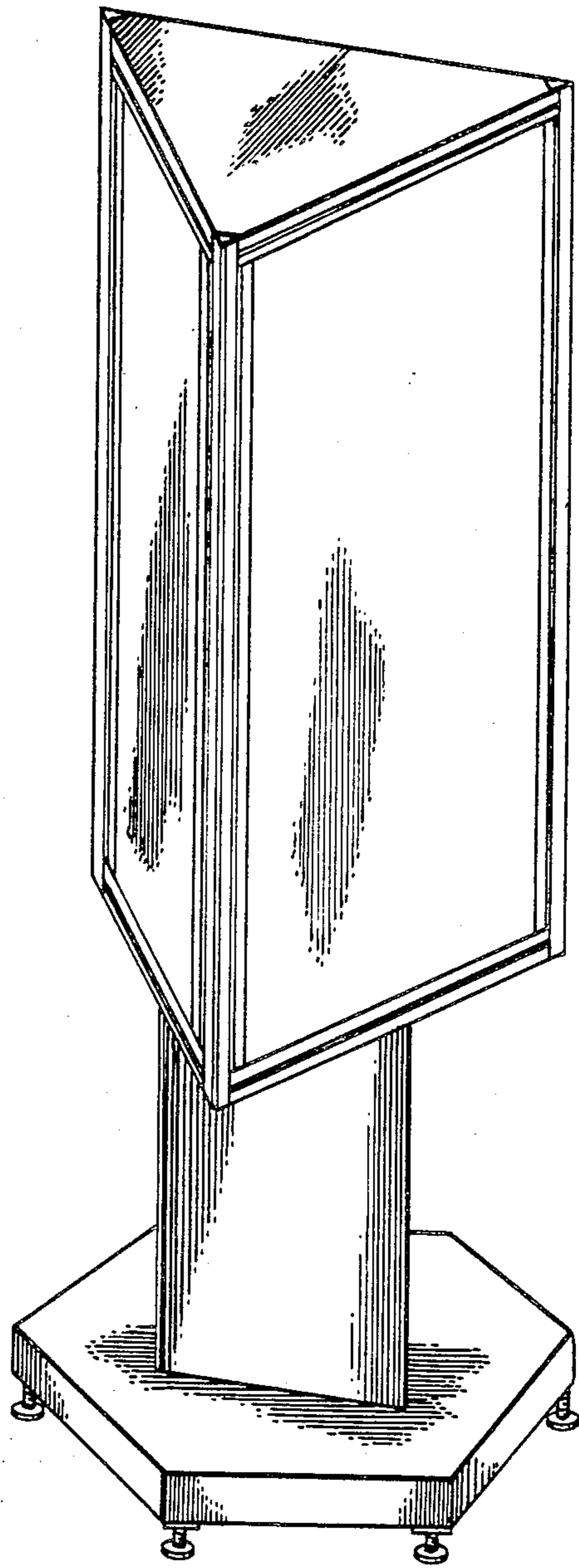
FIG. 35 is a right side elevational view of FIG. 34;

FIG. 36 is a sectional view taken along line 36—36 of FIG. 34; and

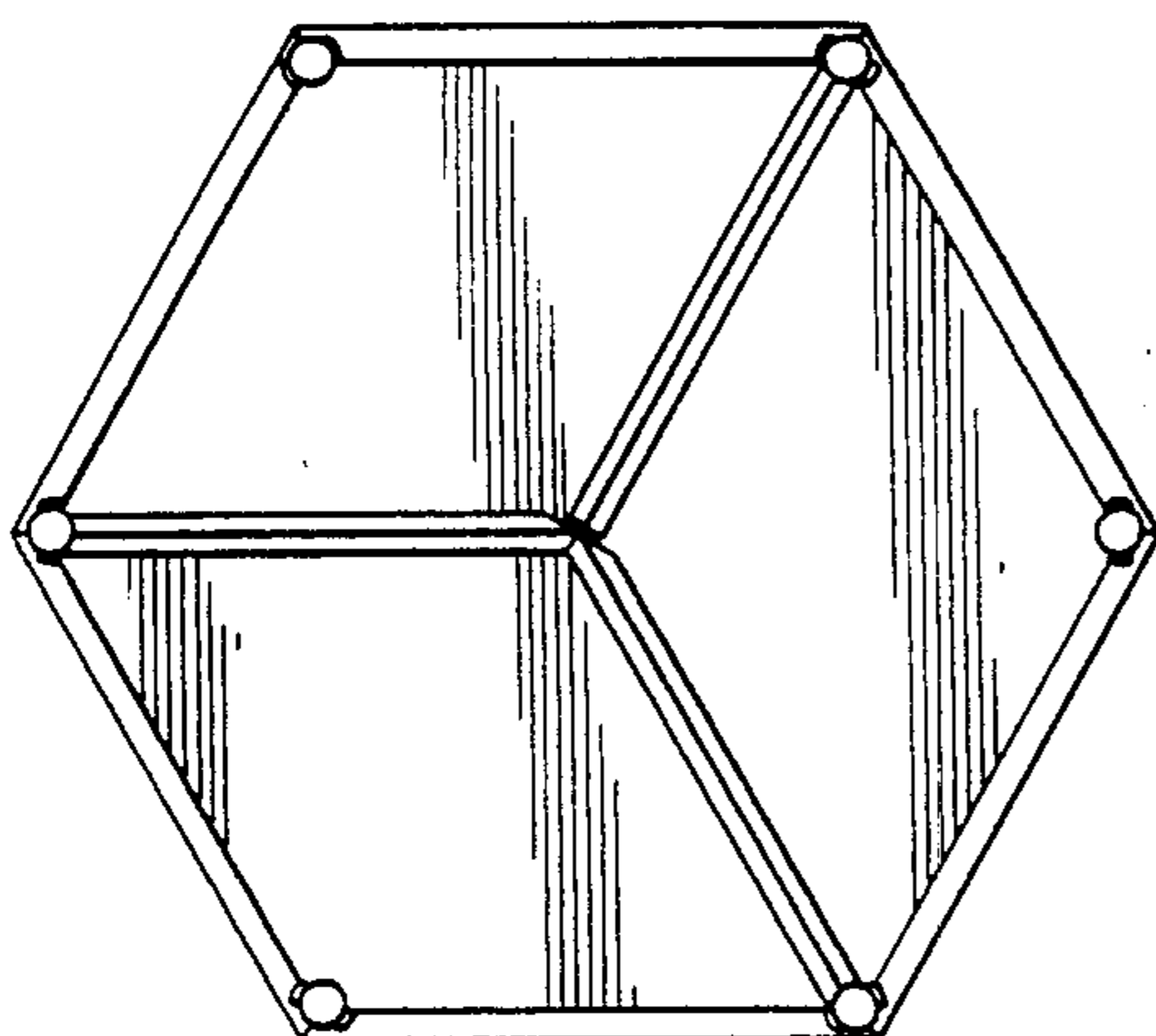
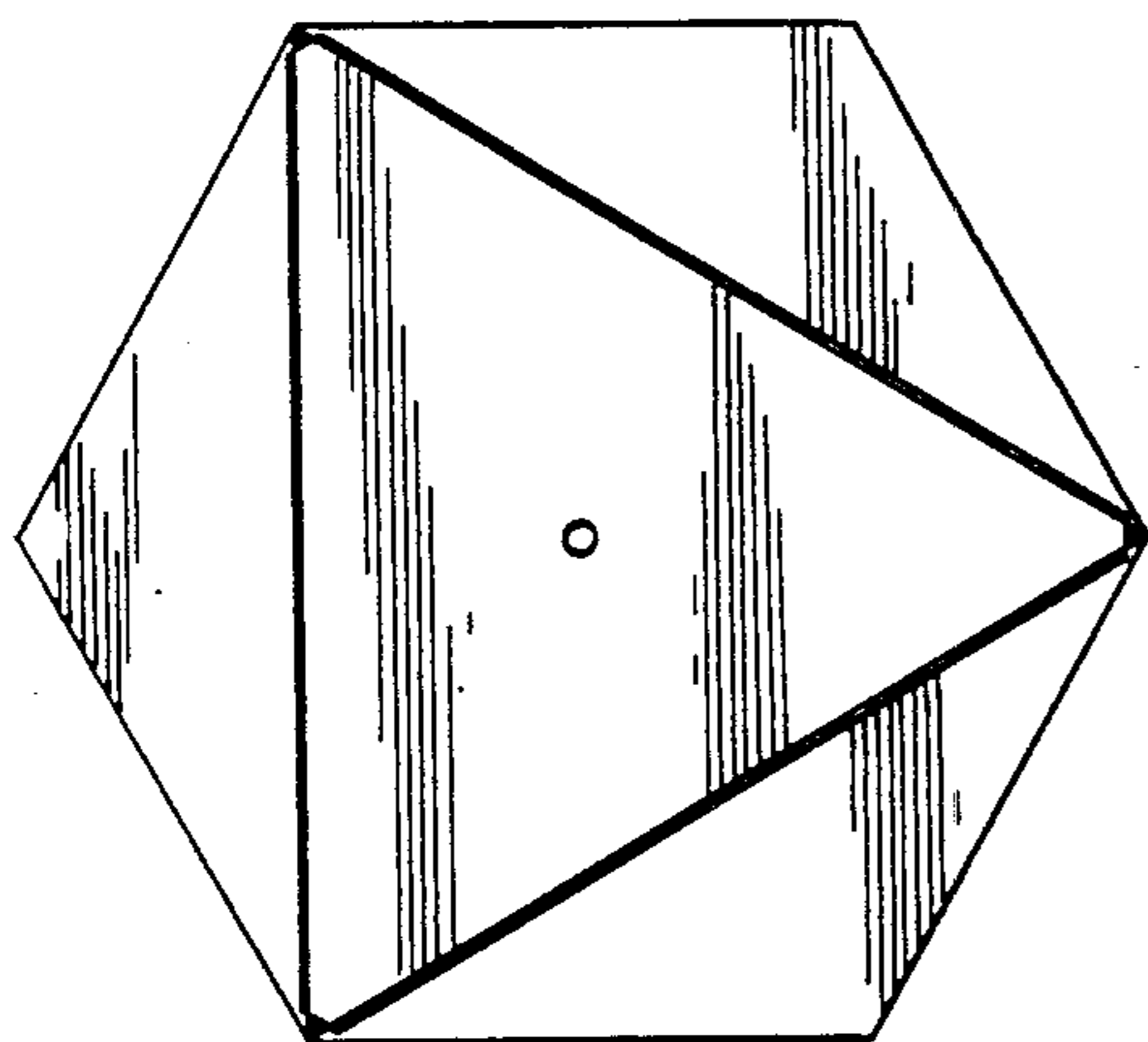
FIG. 37 is a sectional view taken along line 37—37 of FIG. 34.



*FIG. 1*

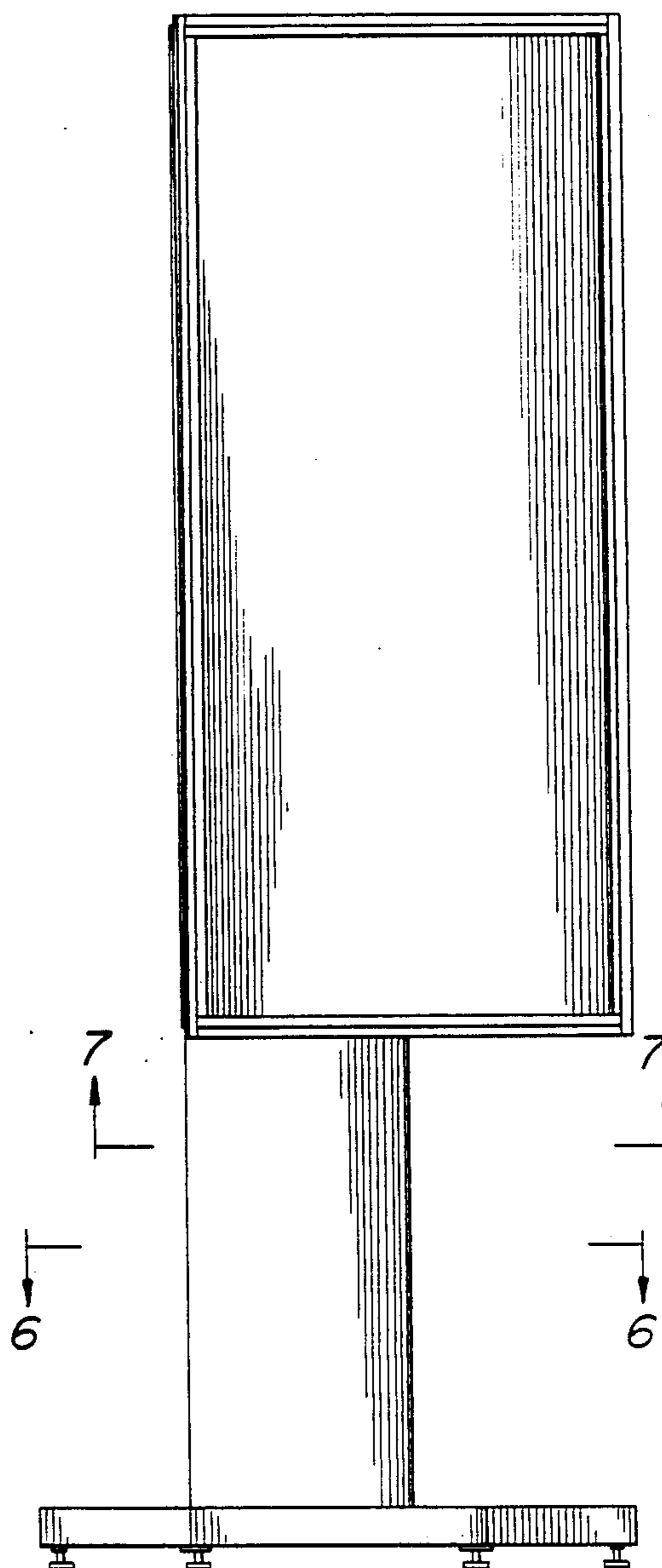


*FIG. 2*

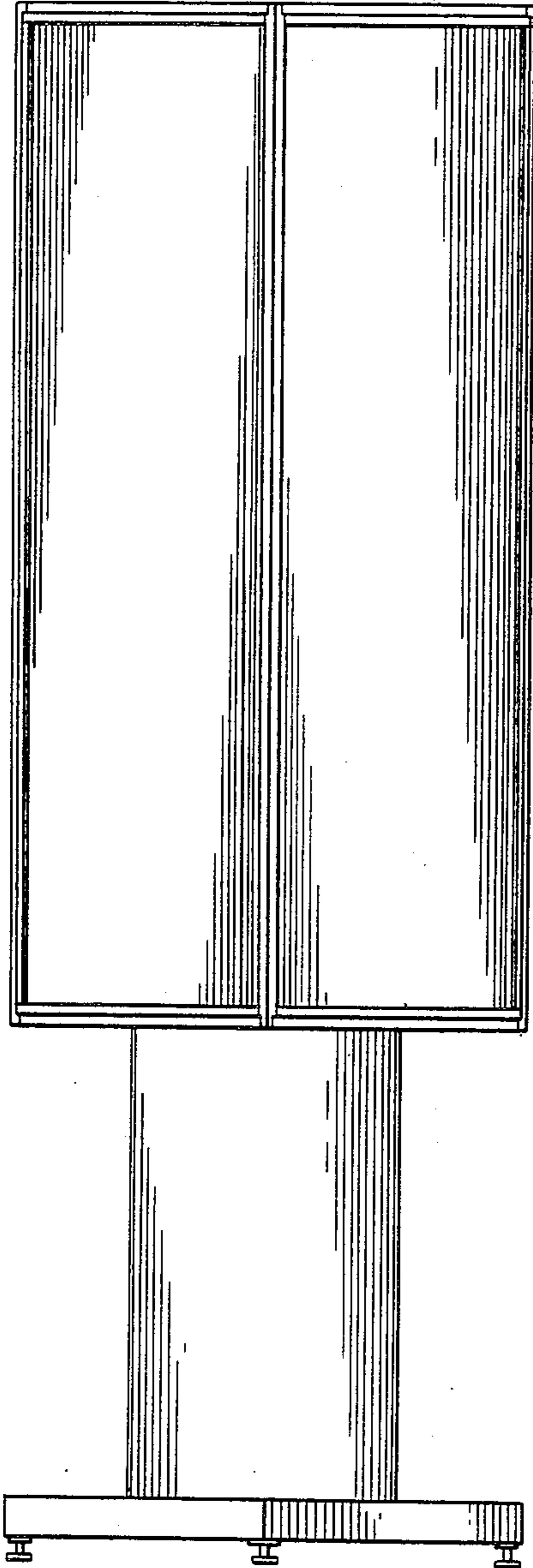


*FIG. 3*

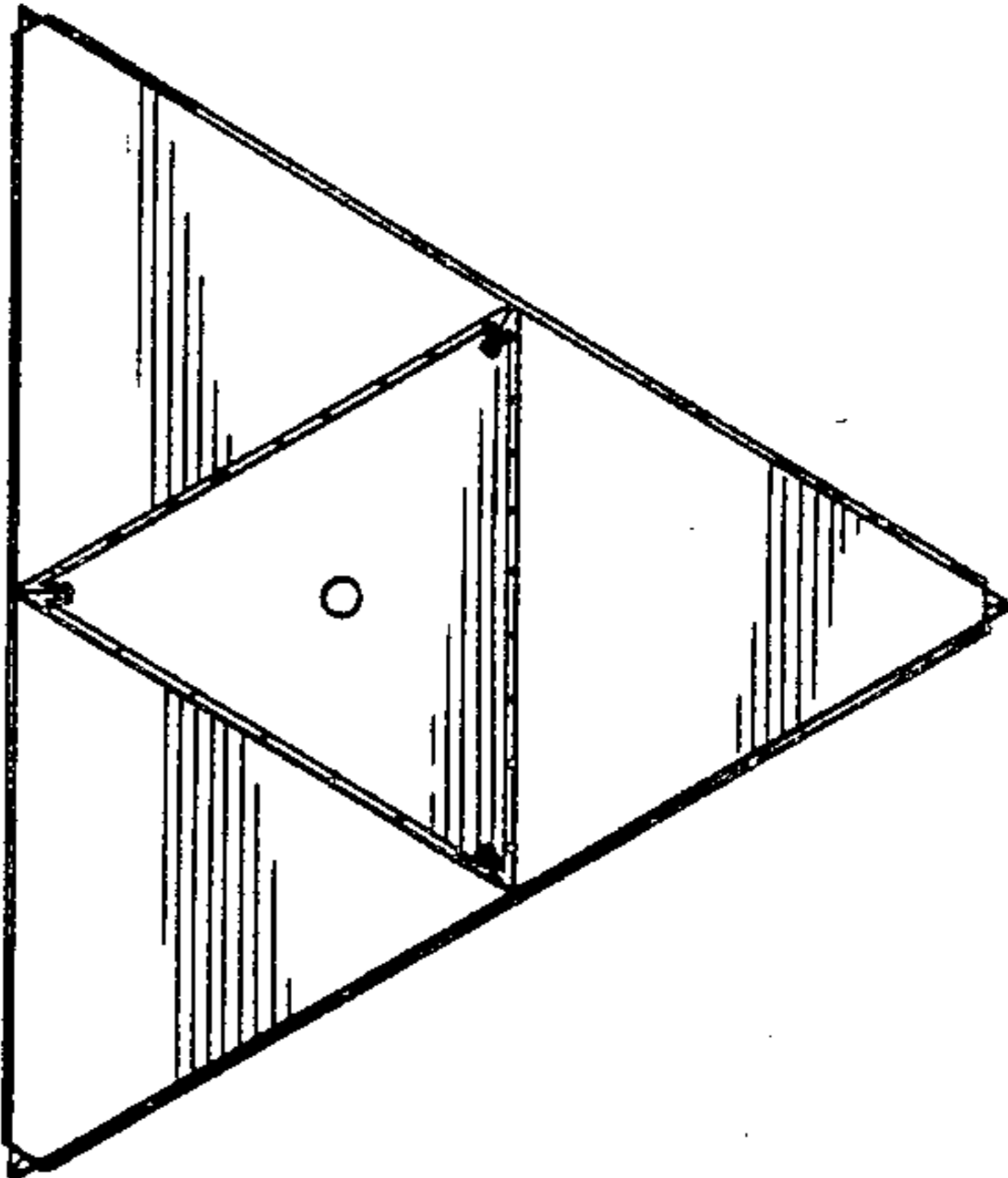
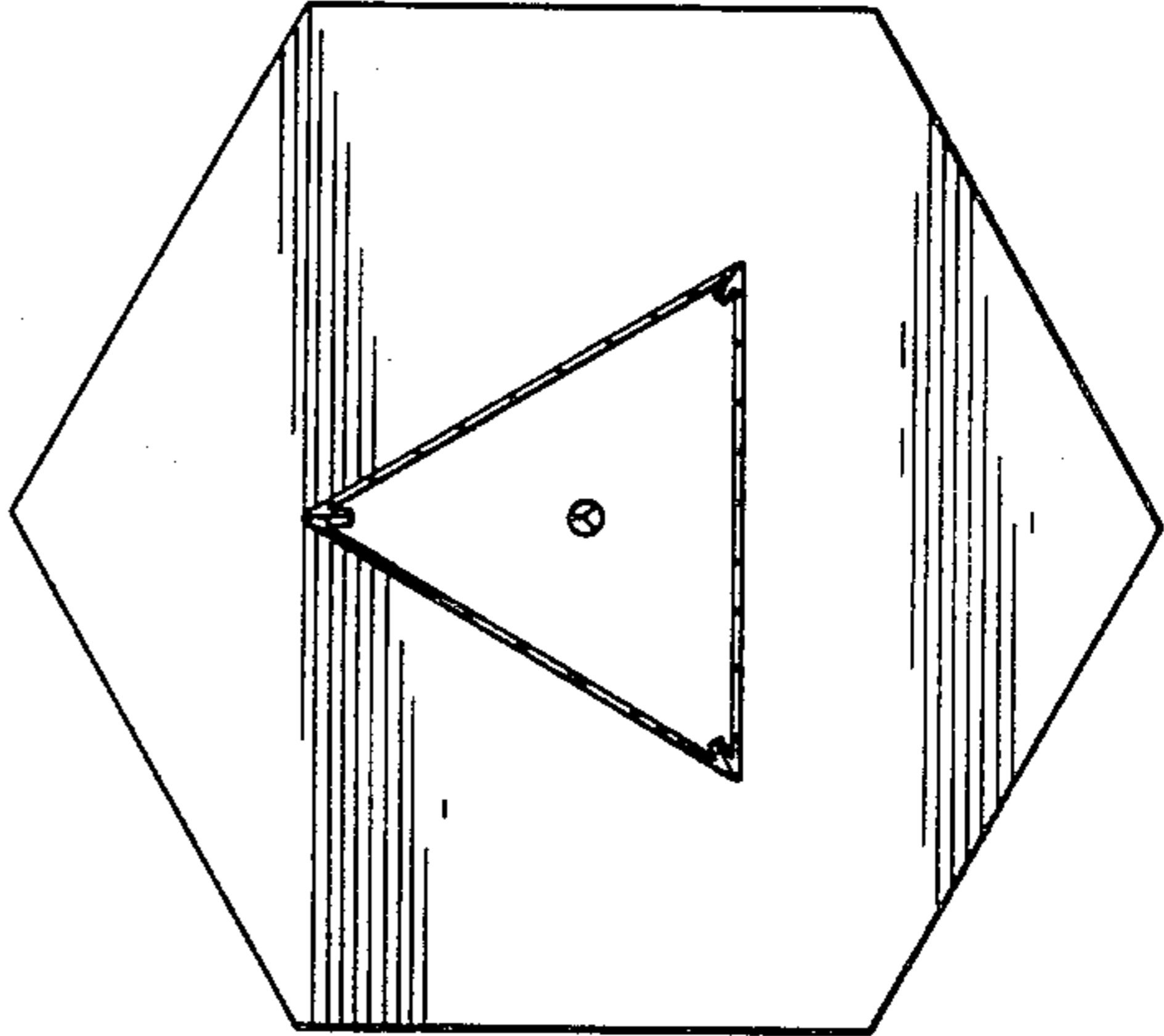
*FIG. 4*



*FIG. 5*

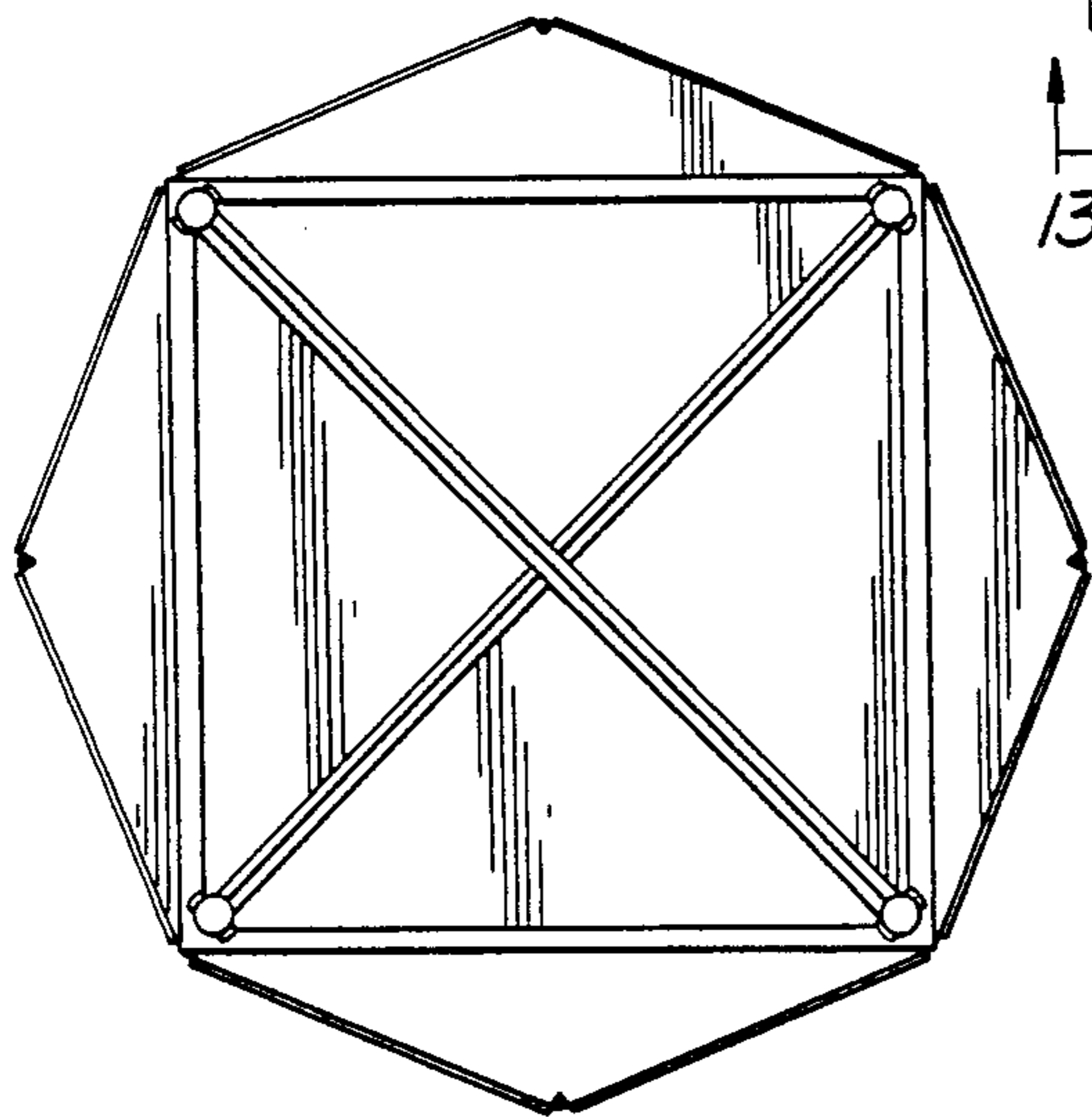
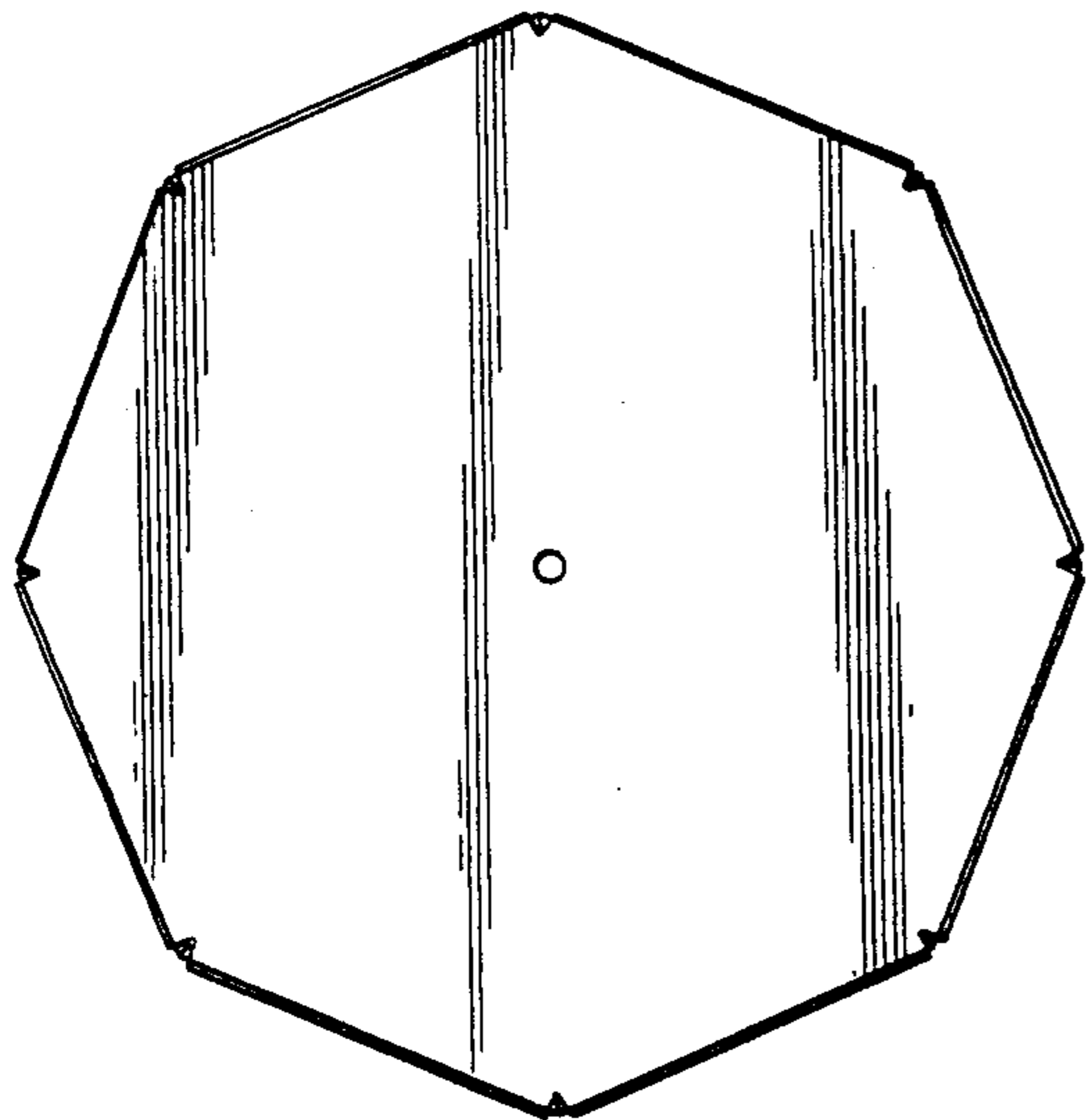


*FIG. 6*

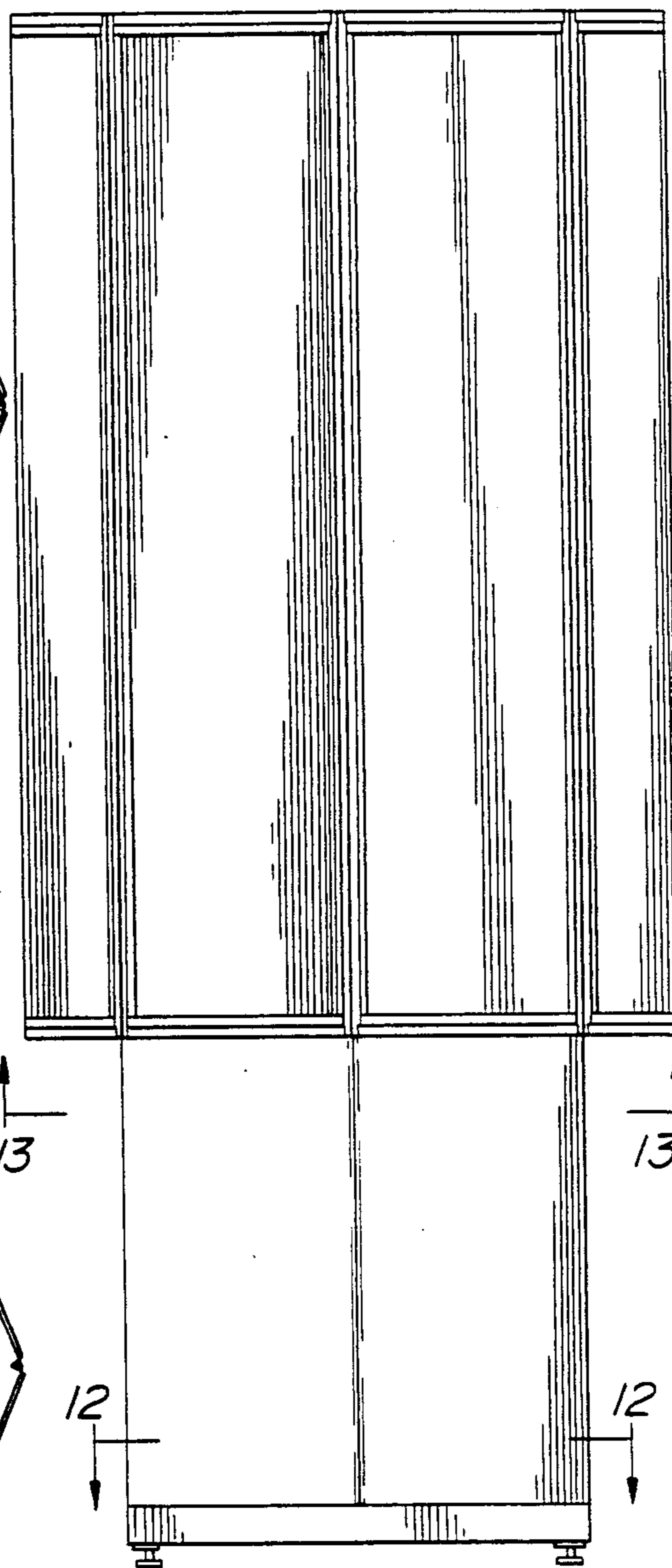


*FIG. 7*

*FIG. 8*

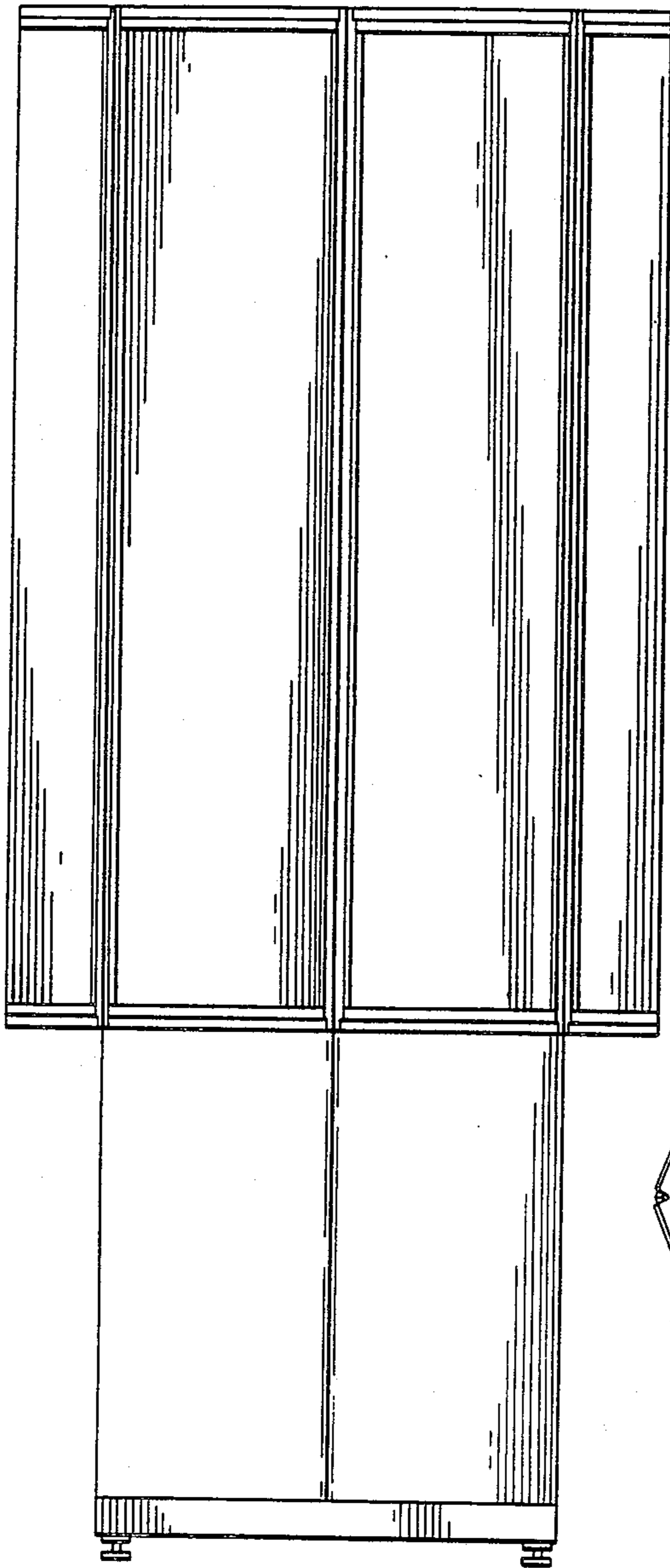


*FIG. 9*

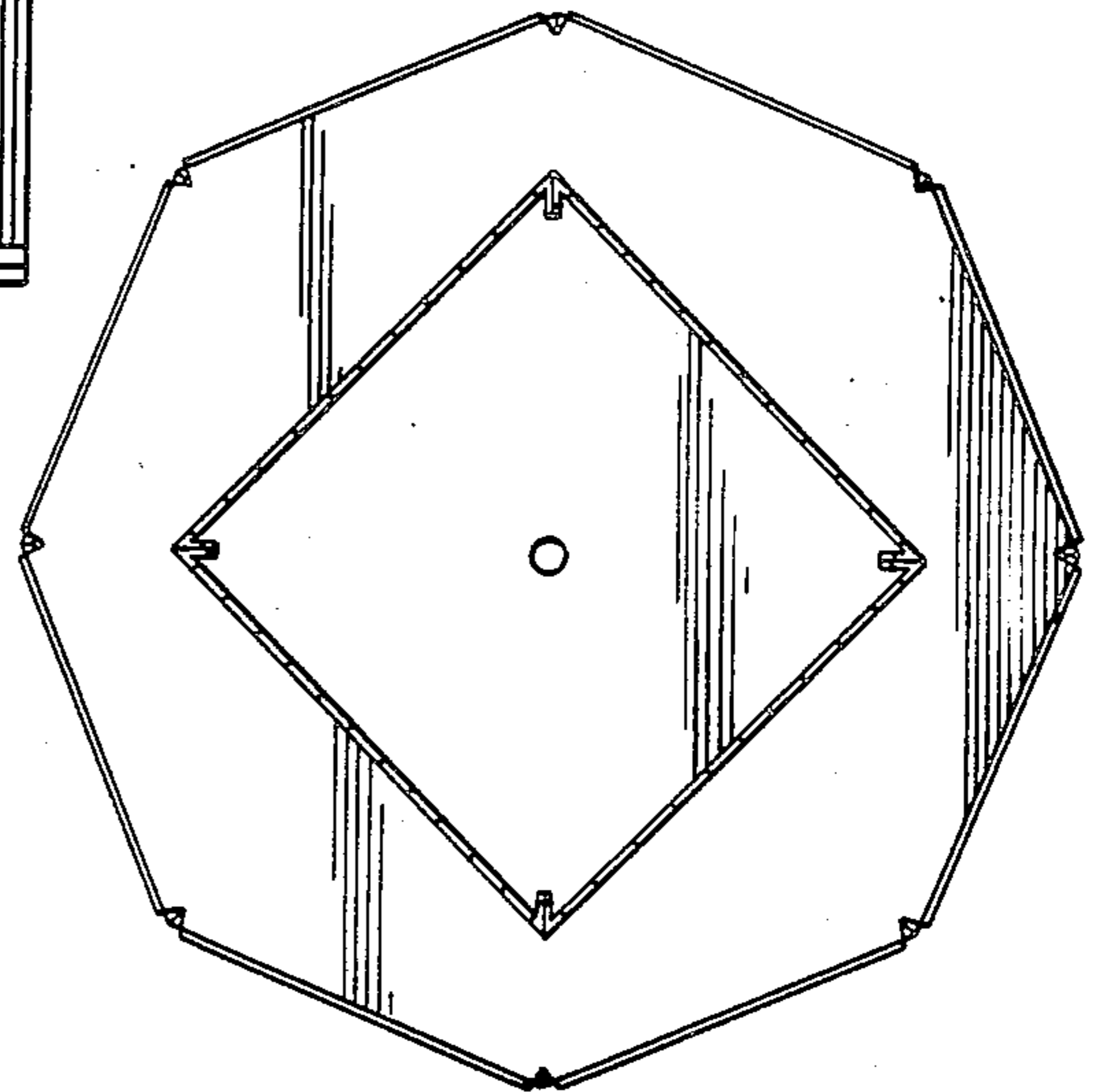
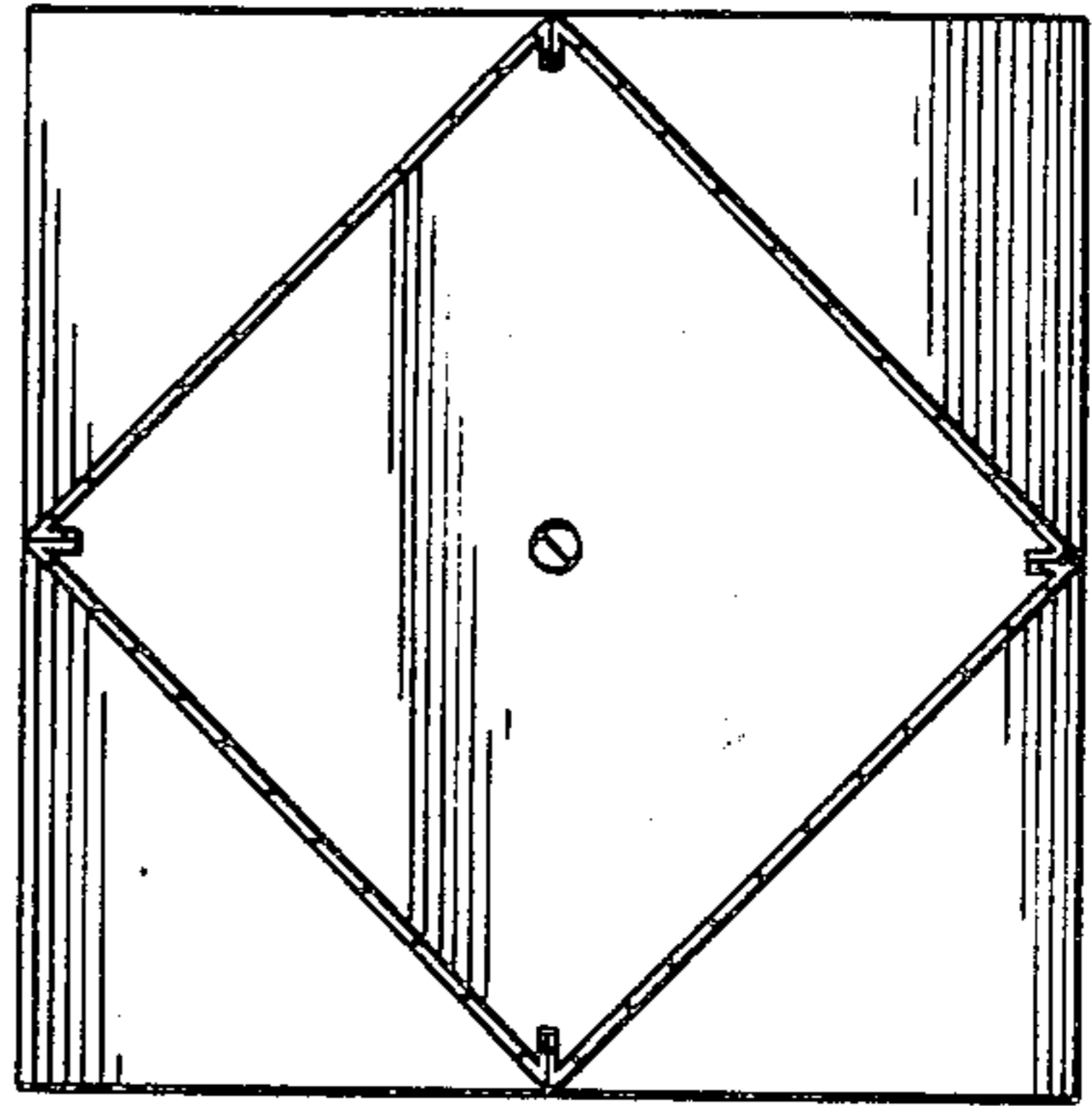


*FIG. 10*

*FIG. 11*

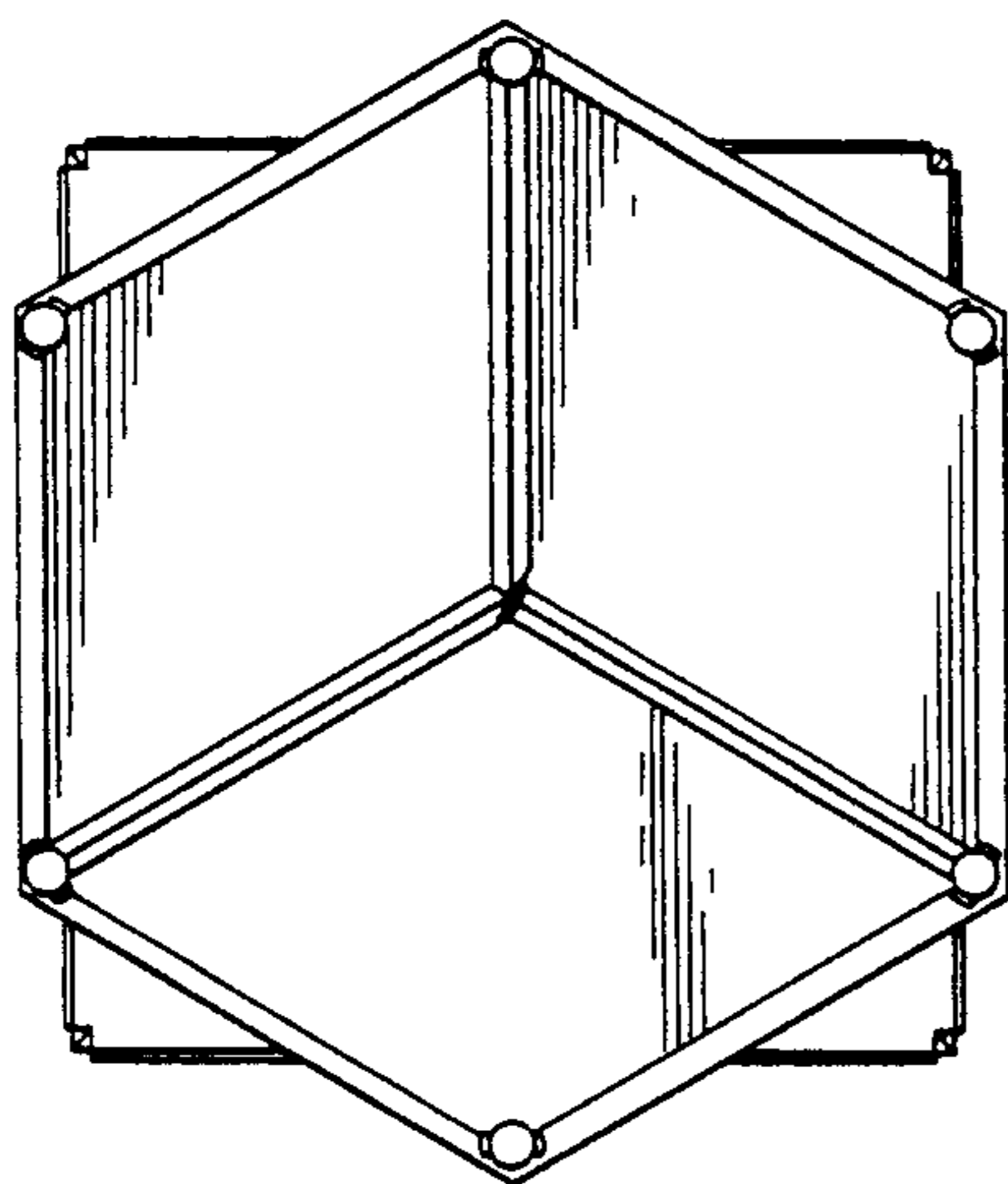
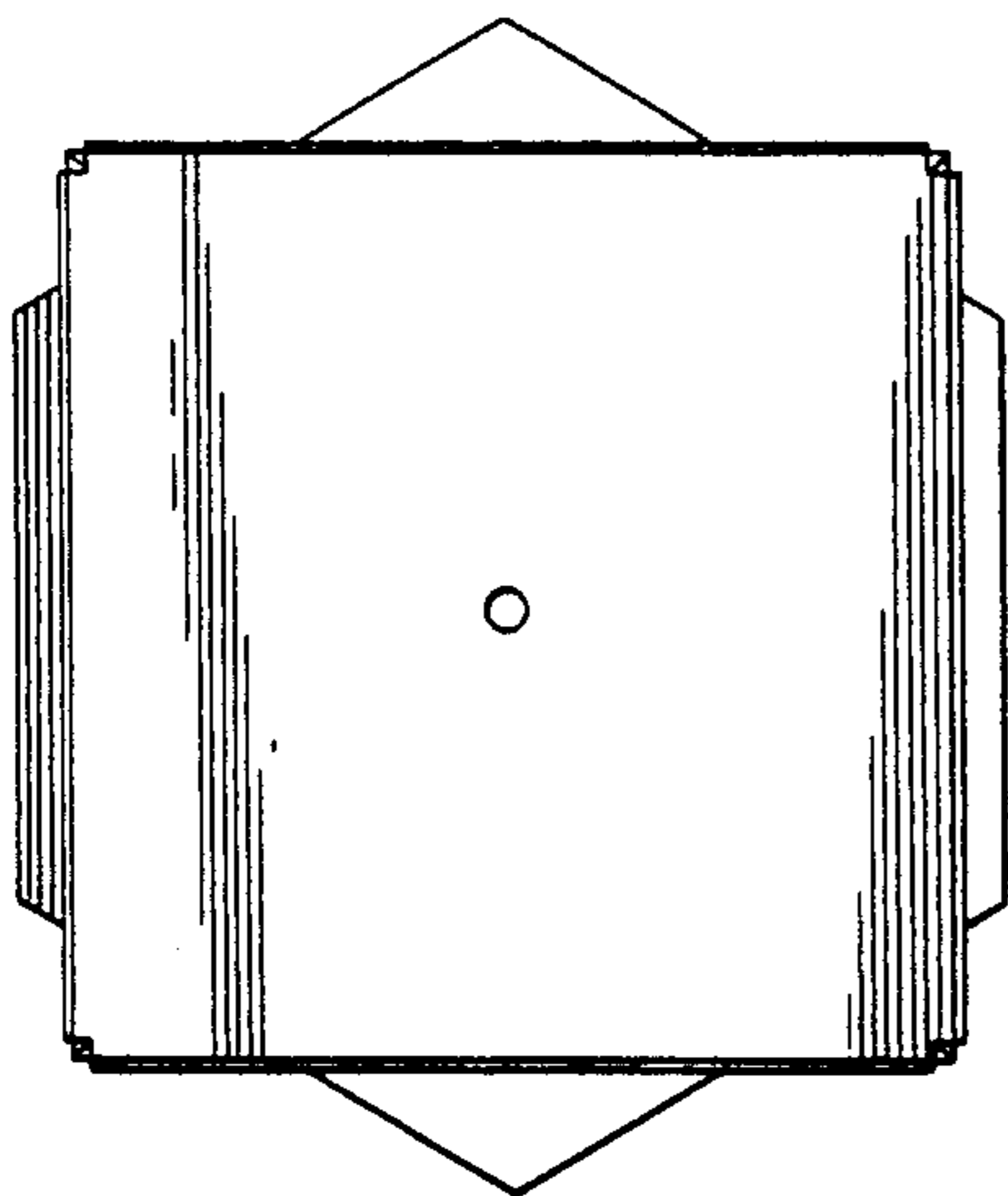


*FIG. 12*



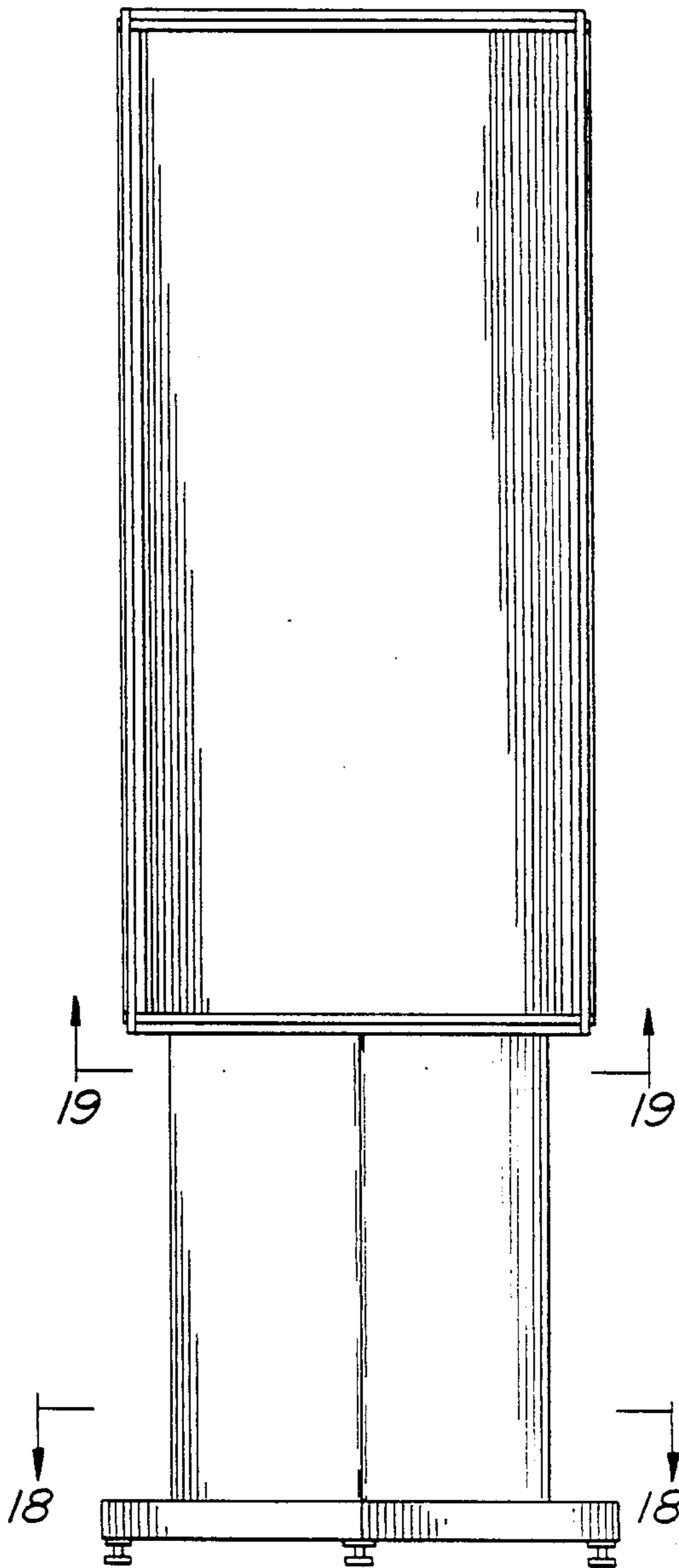
*FIG. 13*

*FIG. 14*

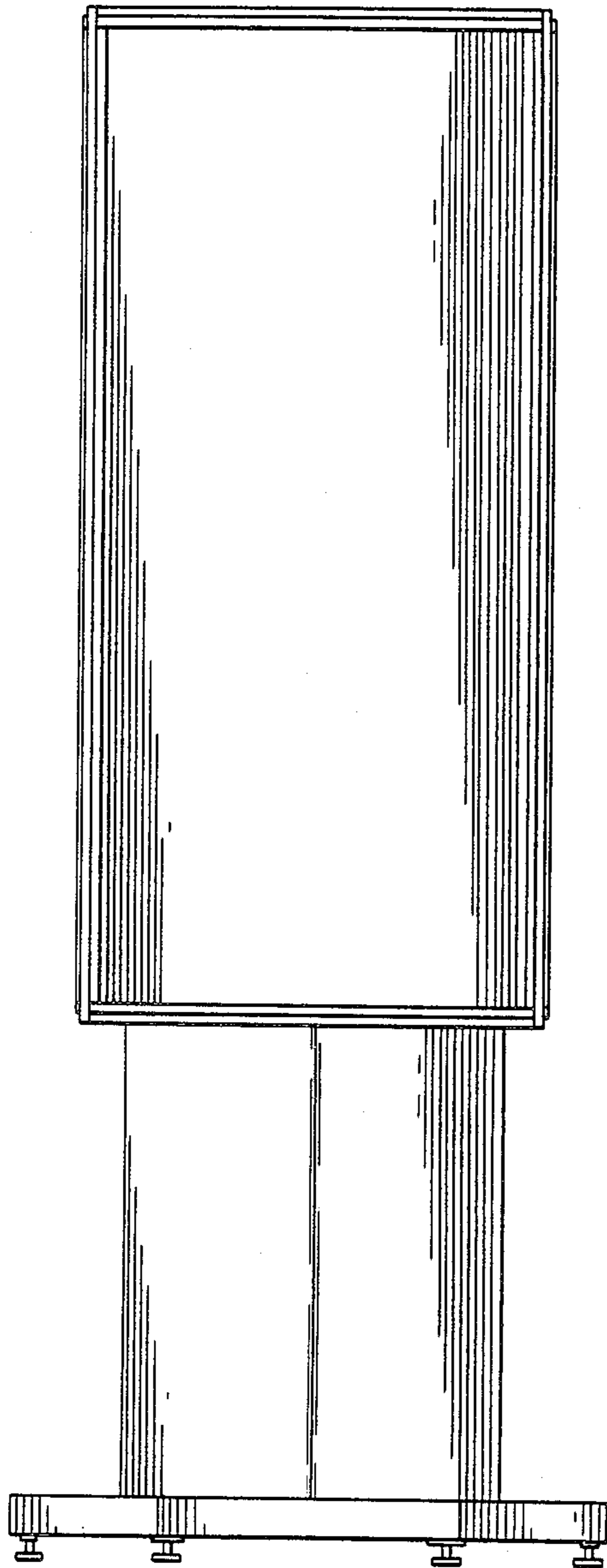


*FIG. 15*

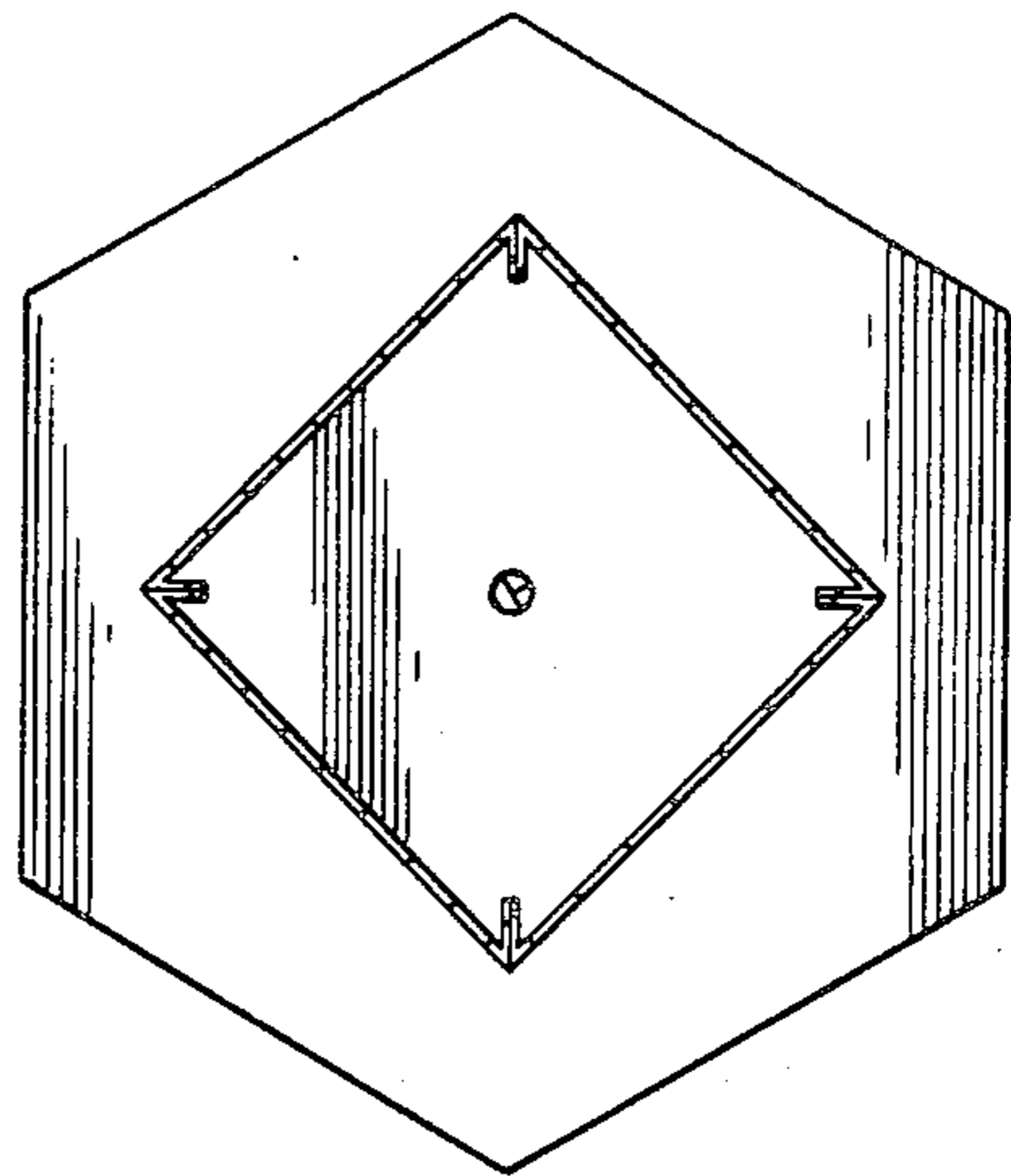
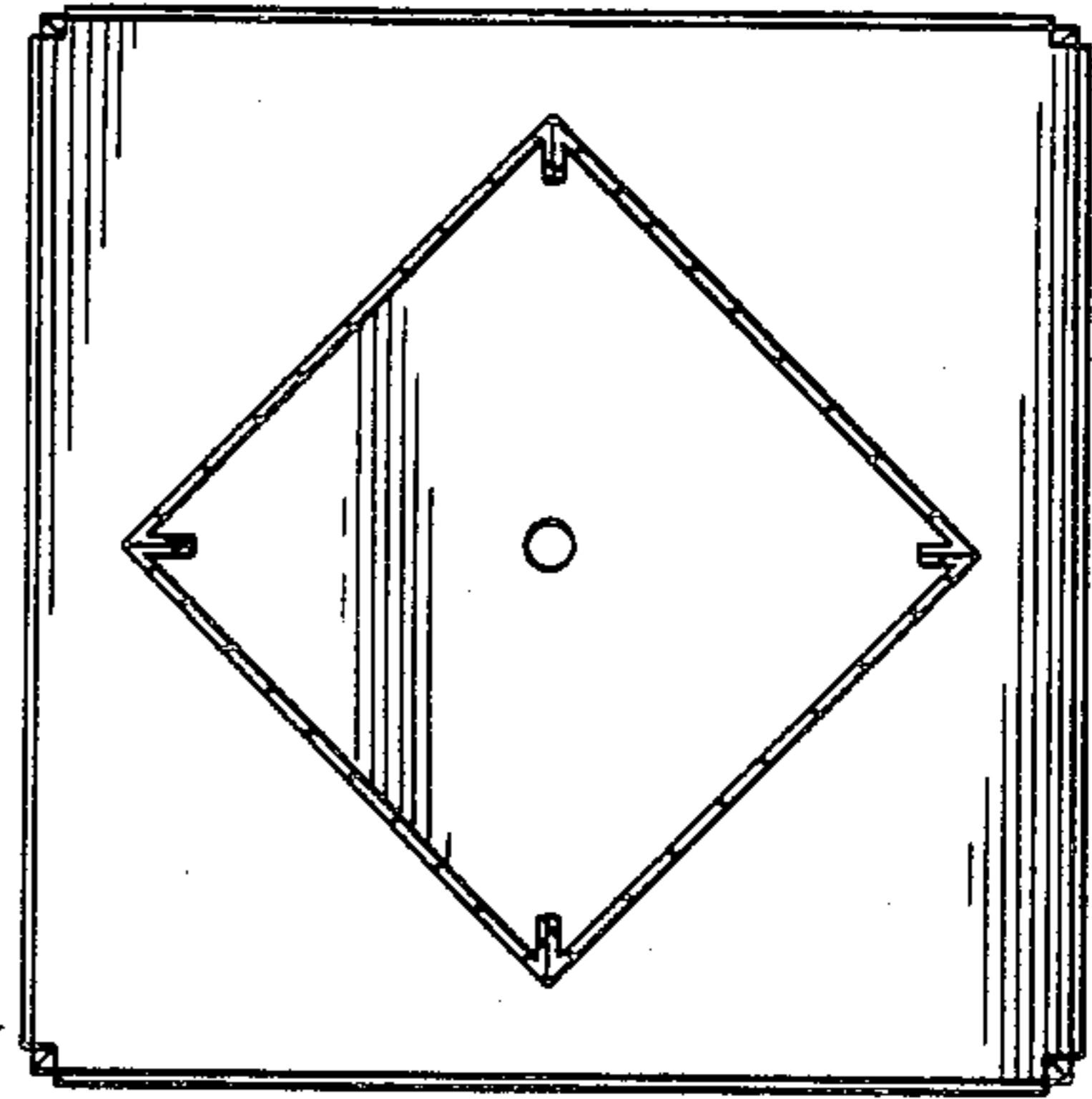
*FIG. 16*



*FIG. 17*



*FIG. 19*



*FIG. 18*



FIG. 20

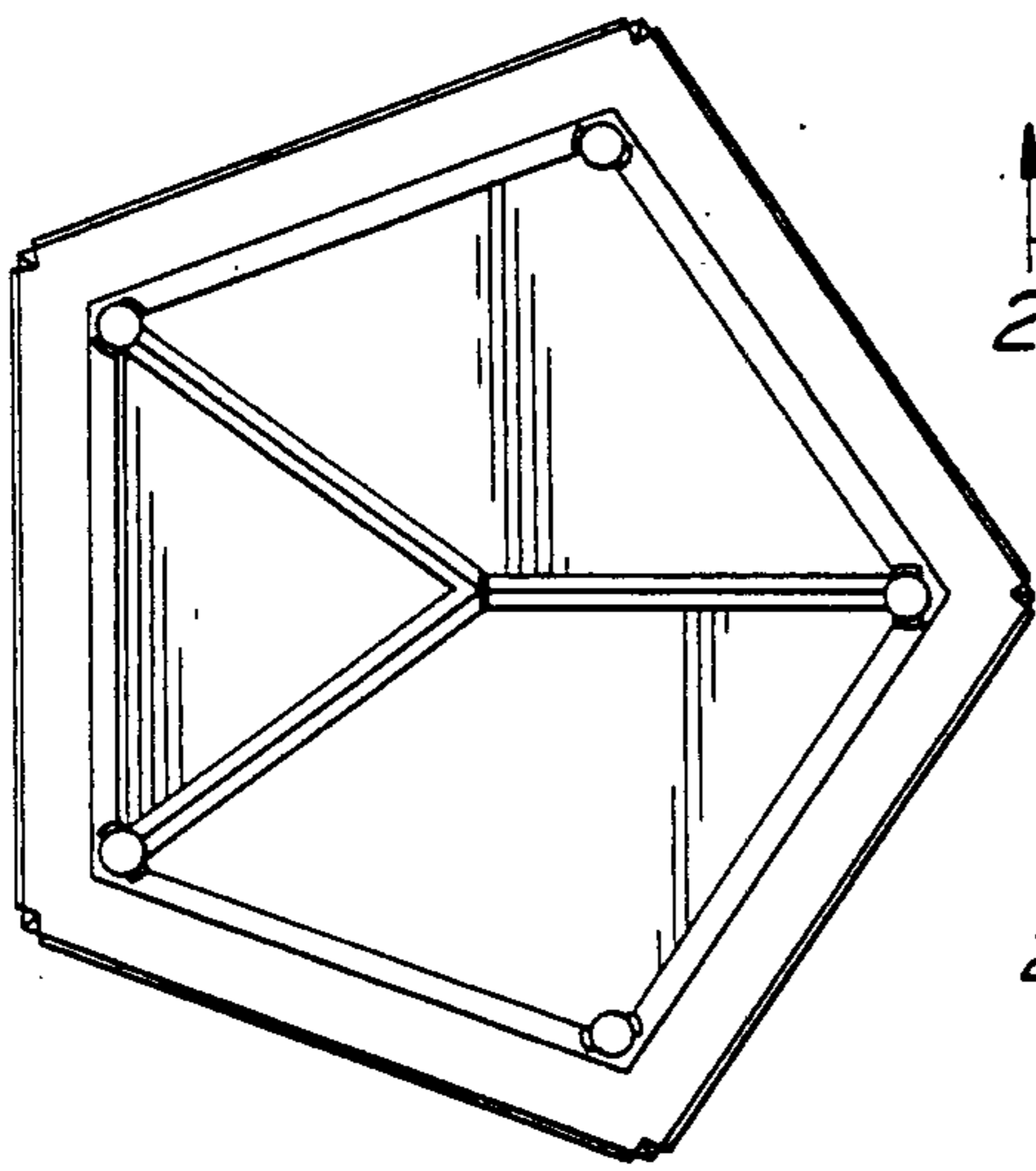
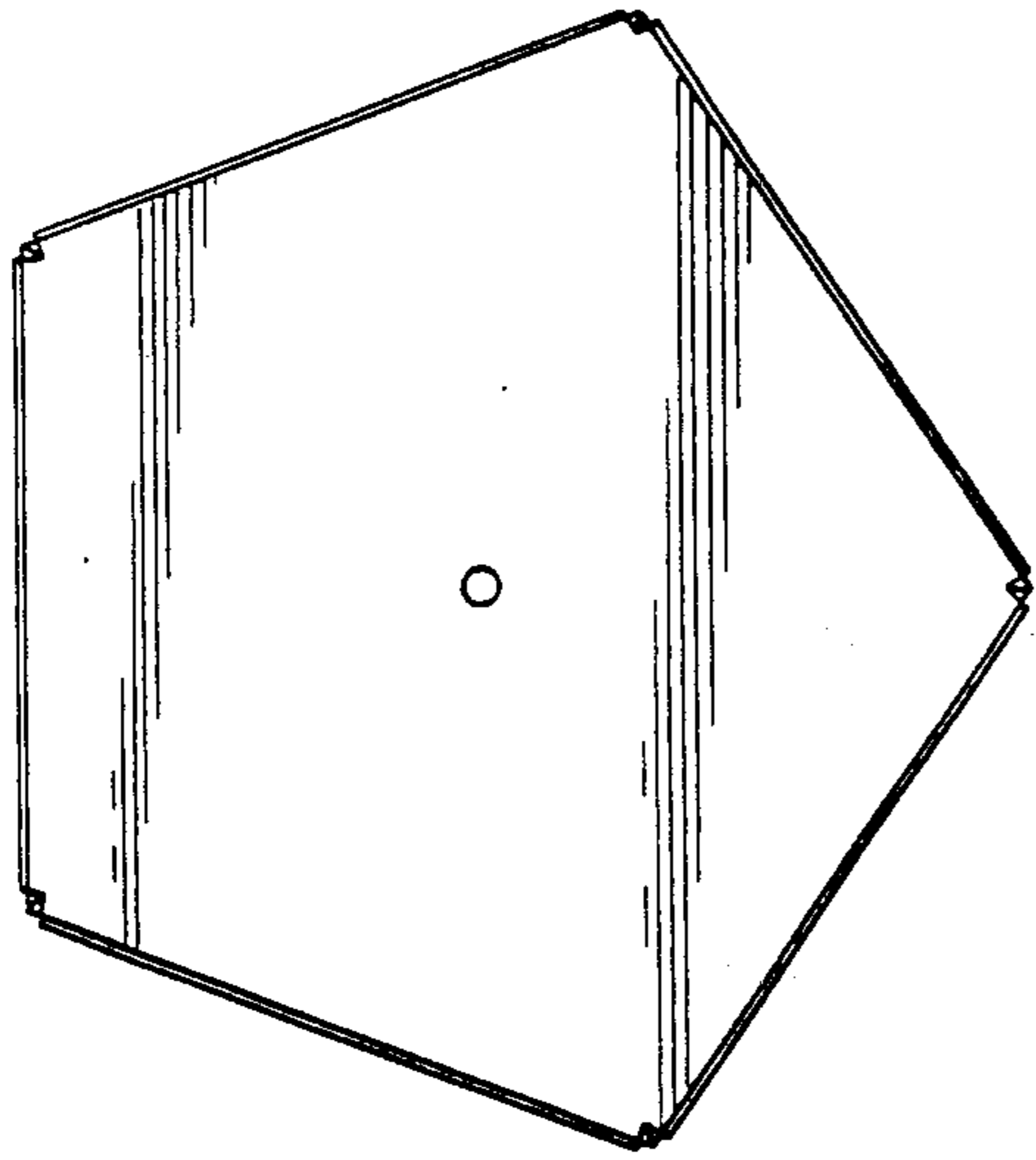
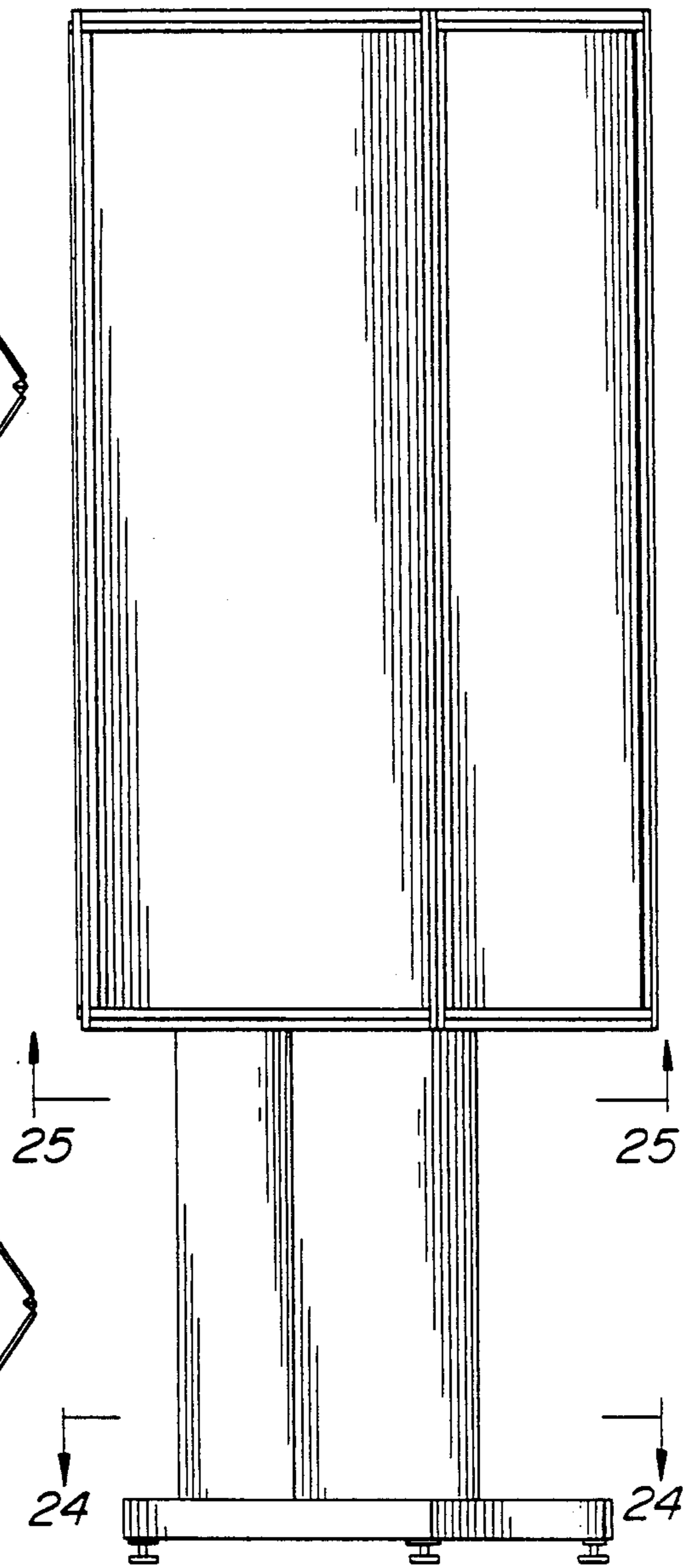
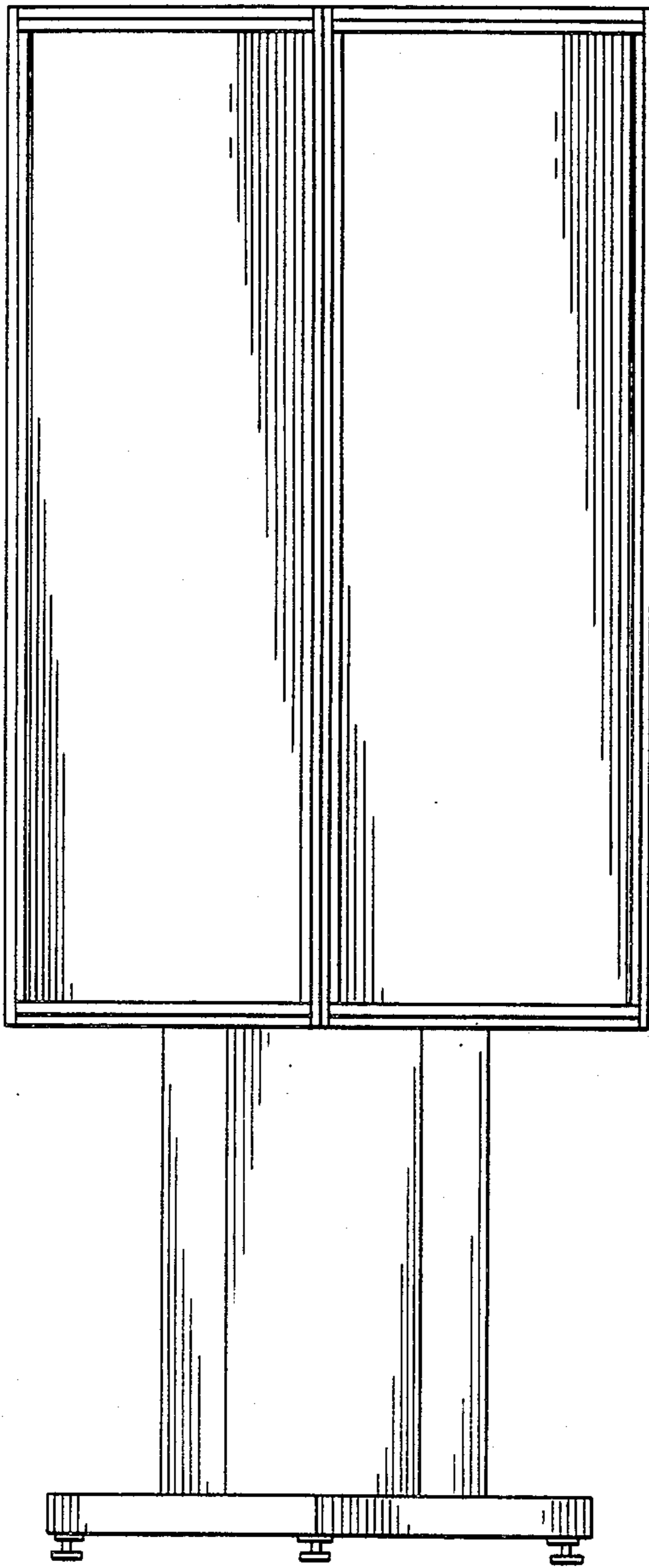


FIG. 21

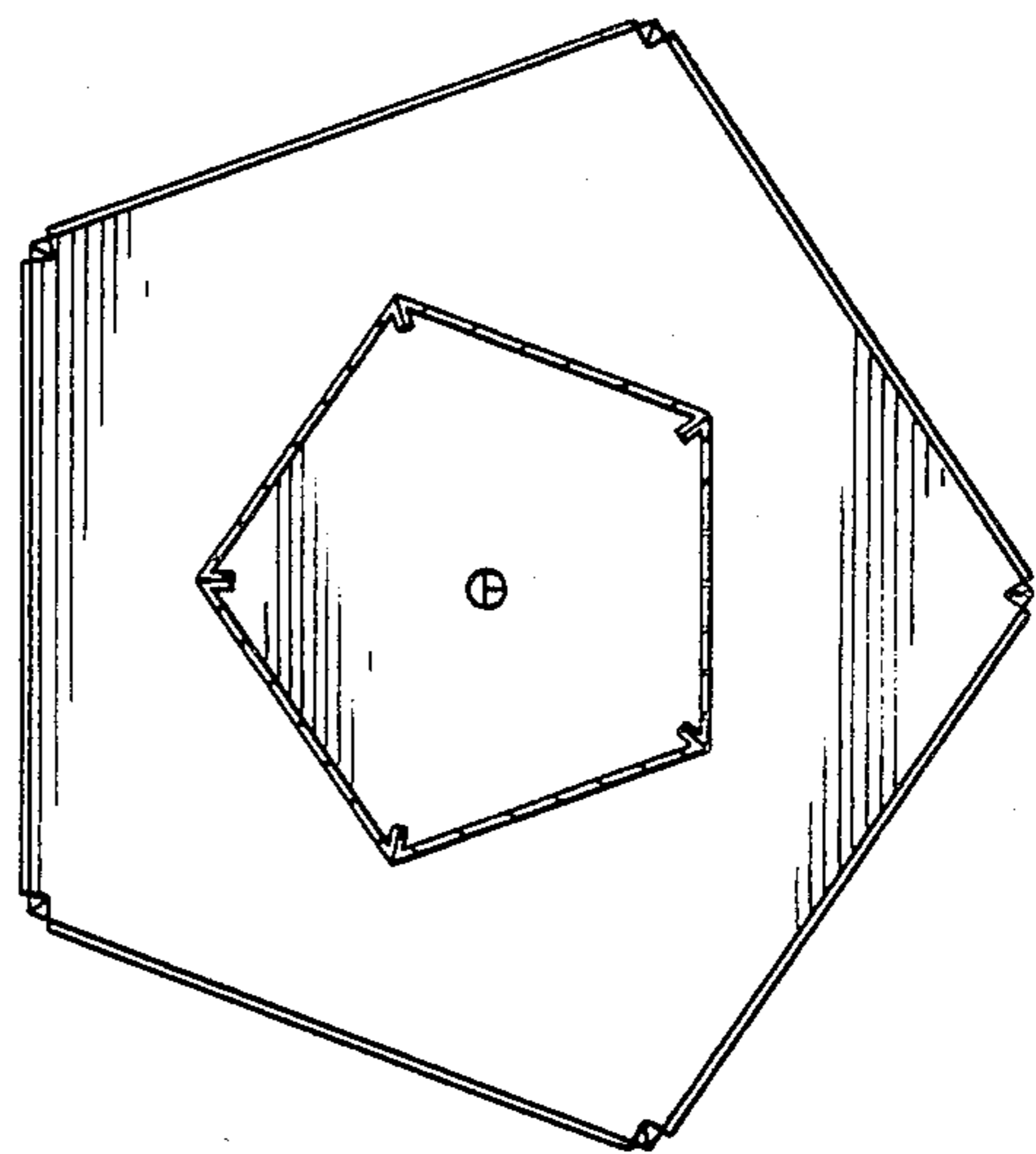
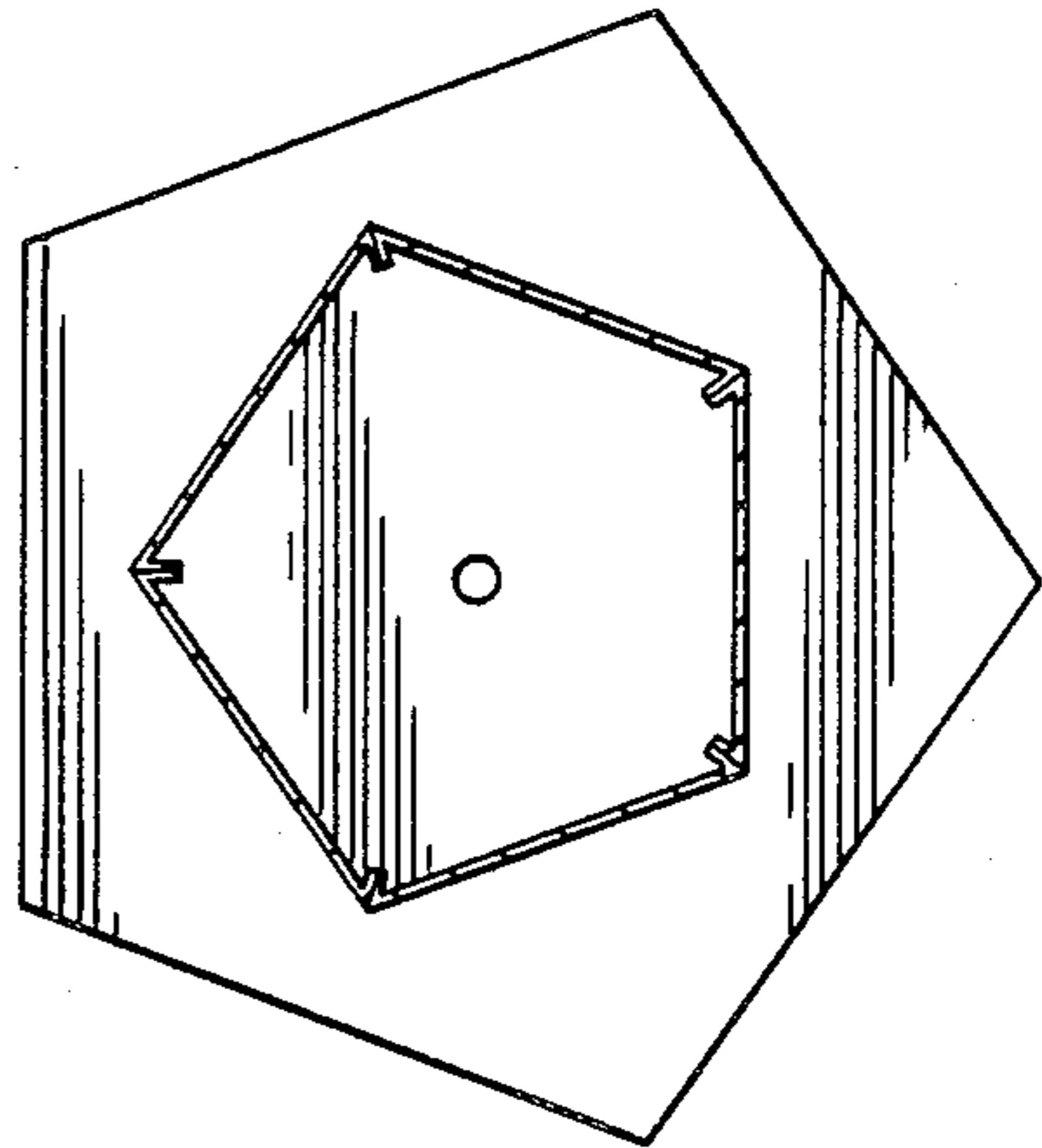
FIG. 22



*FIG. 23*



*FIG. 24*



*FIG. 25*

FIG. 26

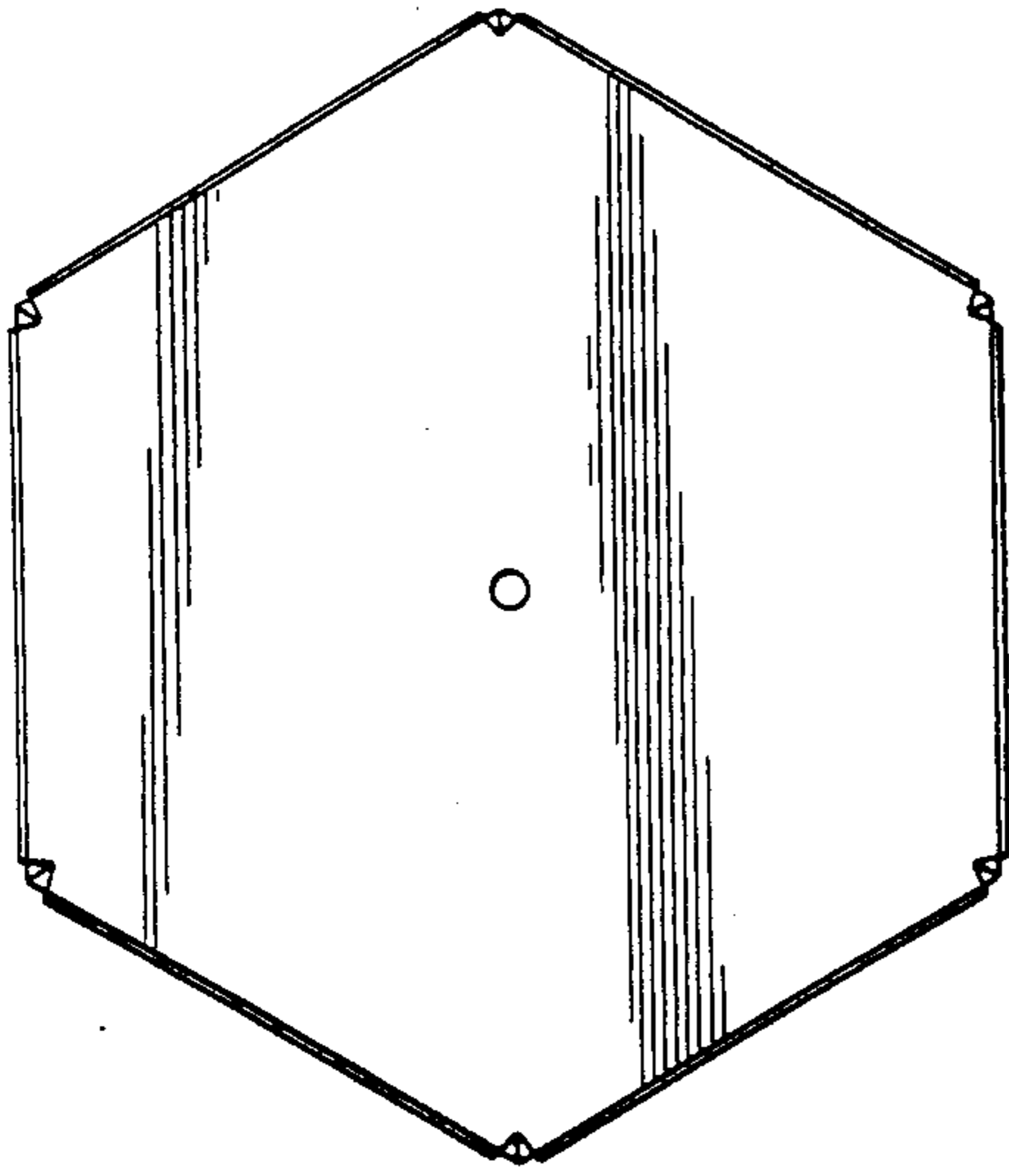


FIG. 28

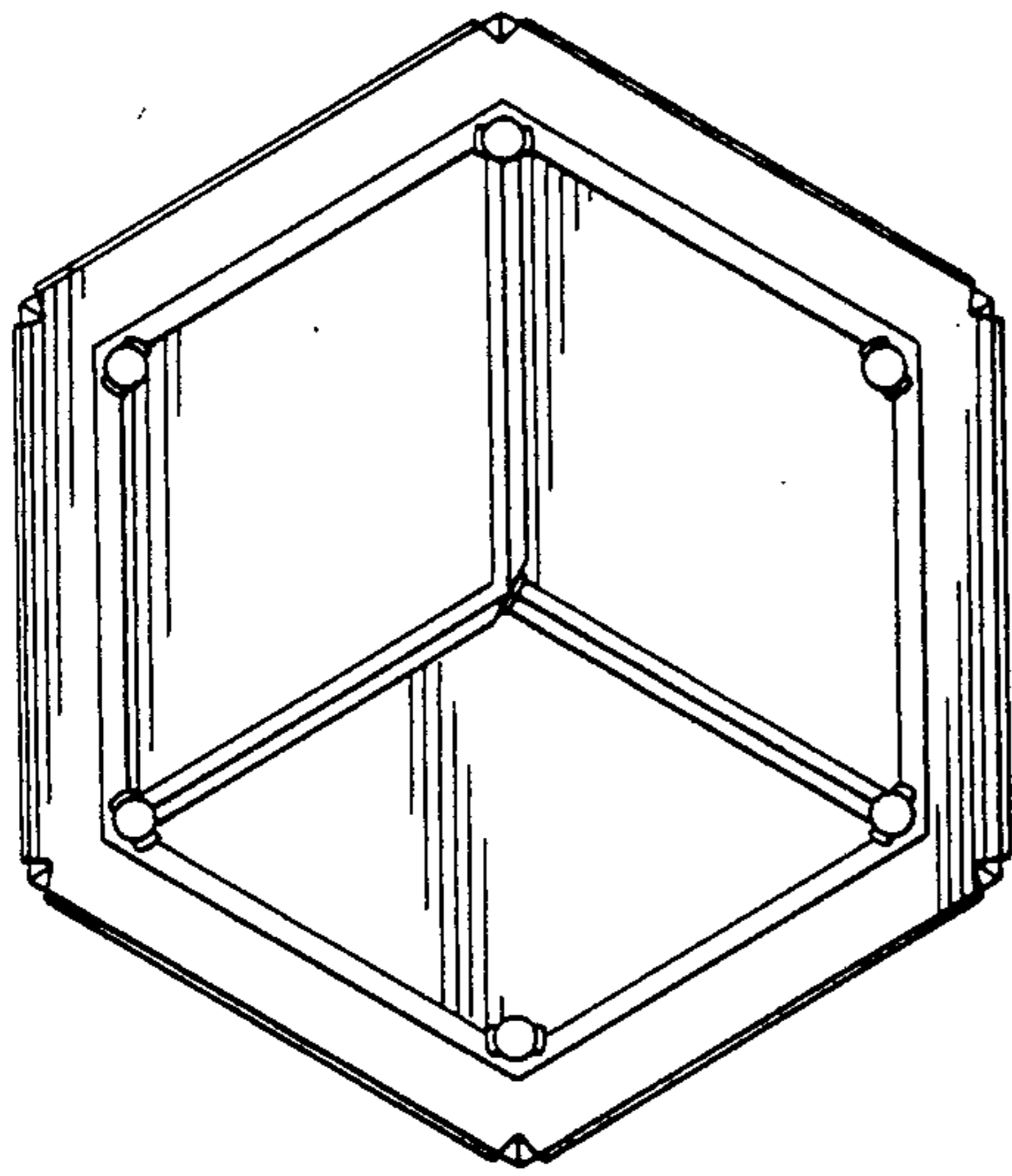
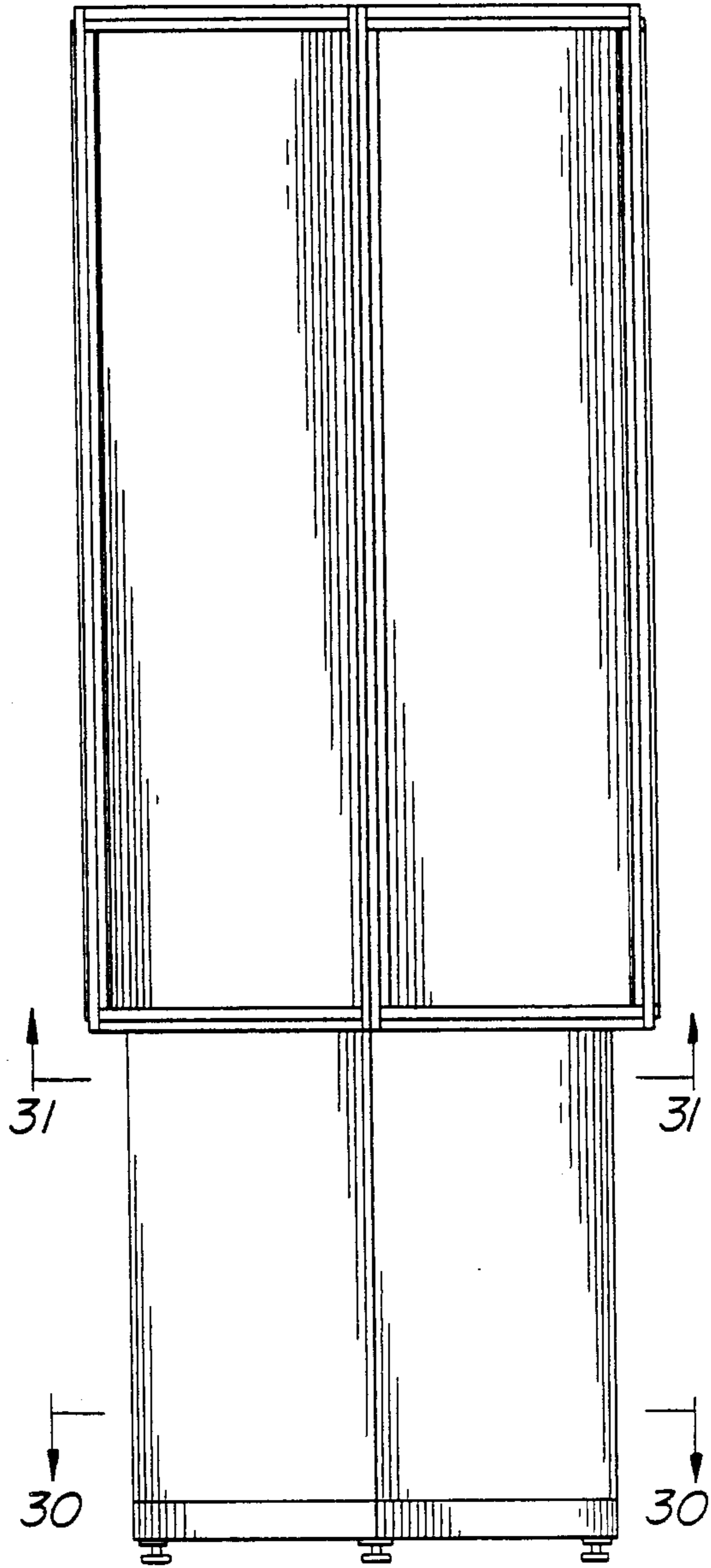
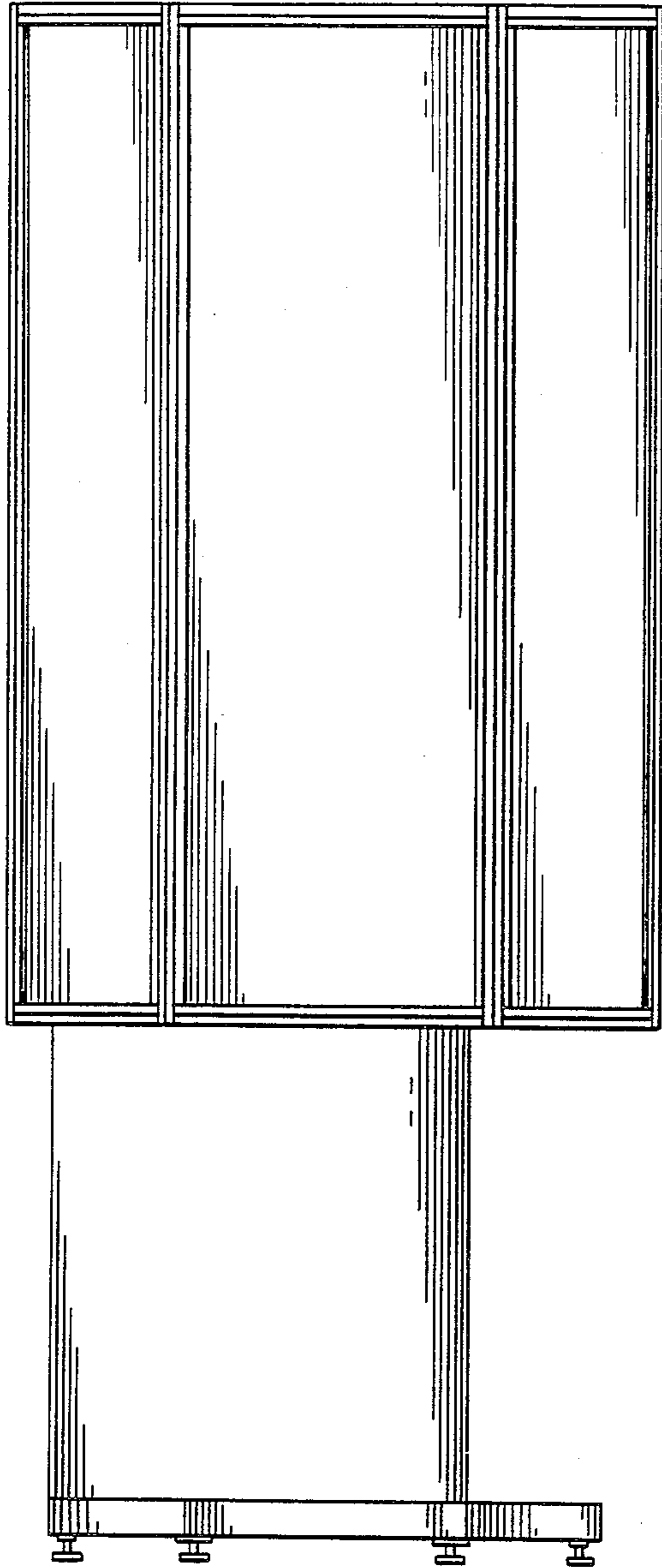
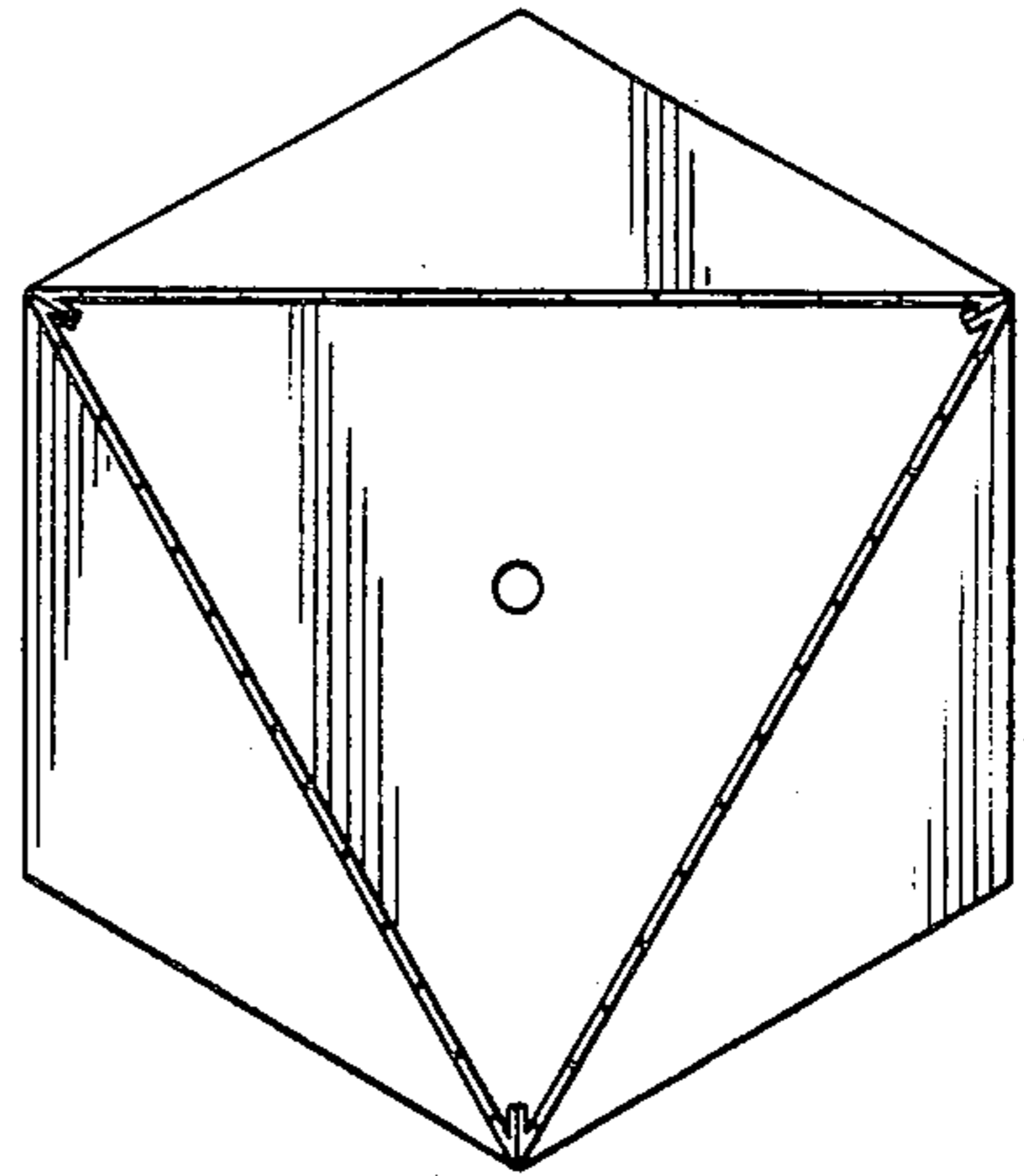


FIG. 27

*FIG. 29*



*FIG. 30*



*FIG. 31*

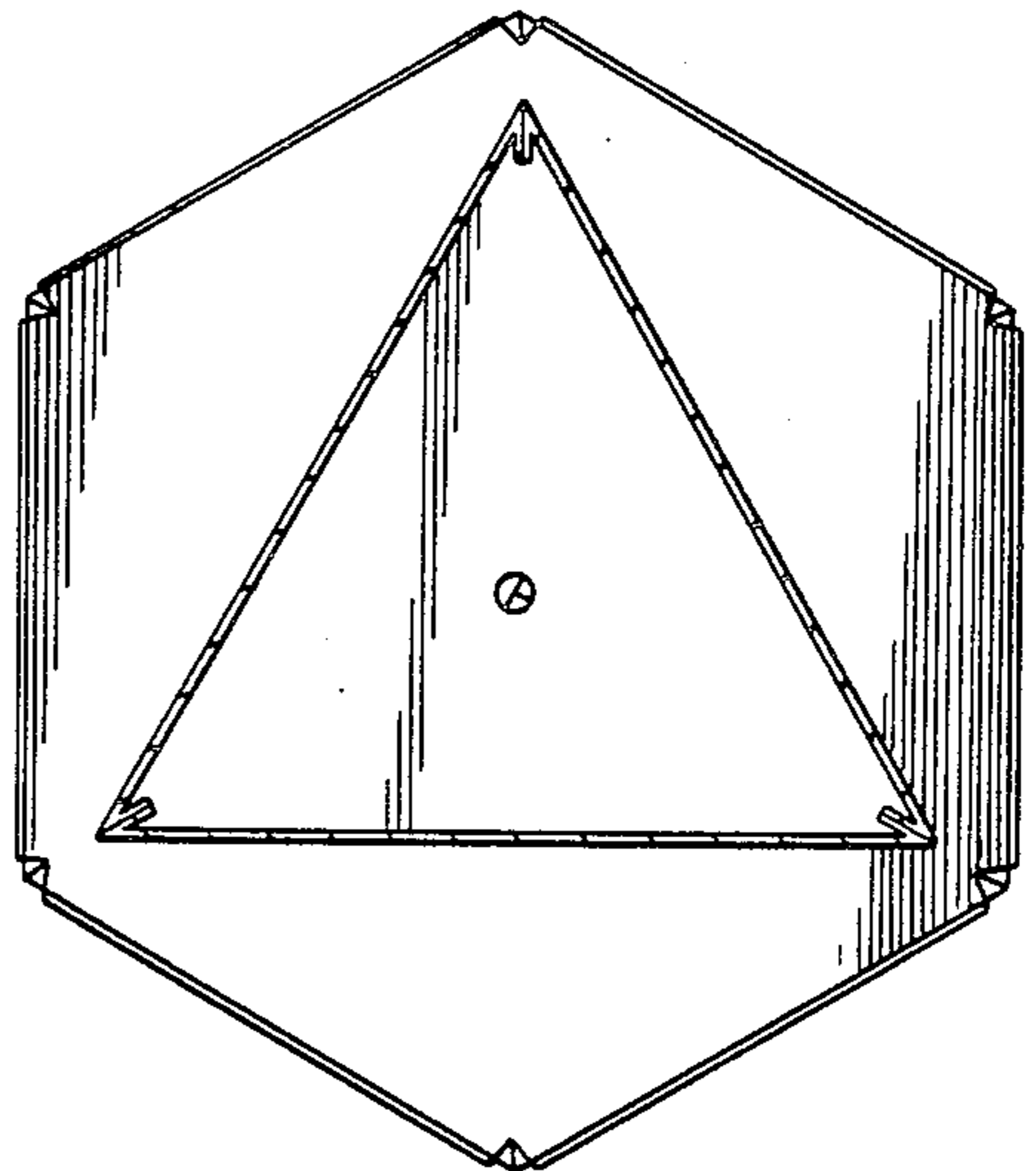


FIG. 34

FIG. 32

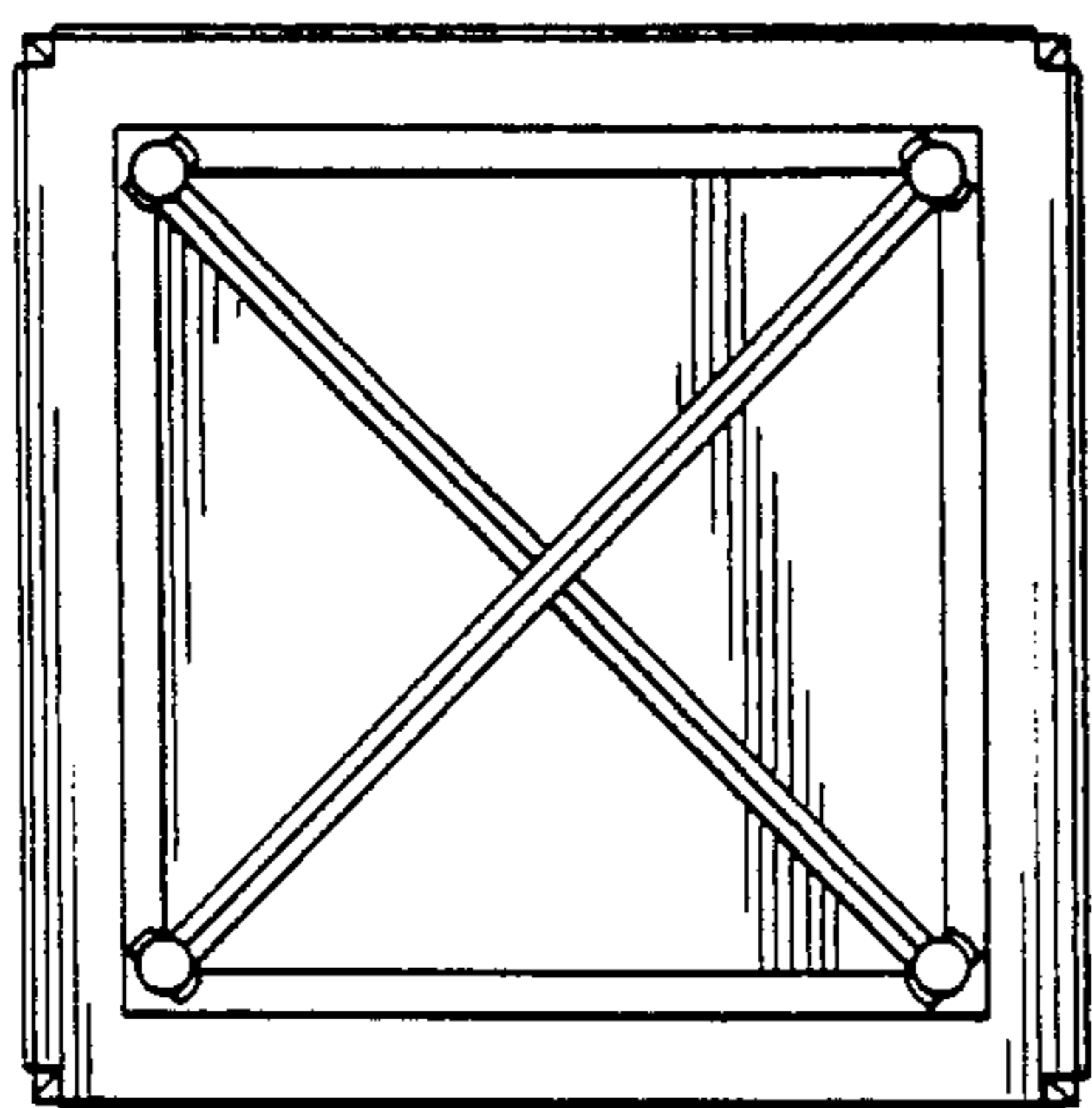
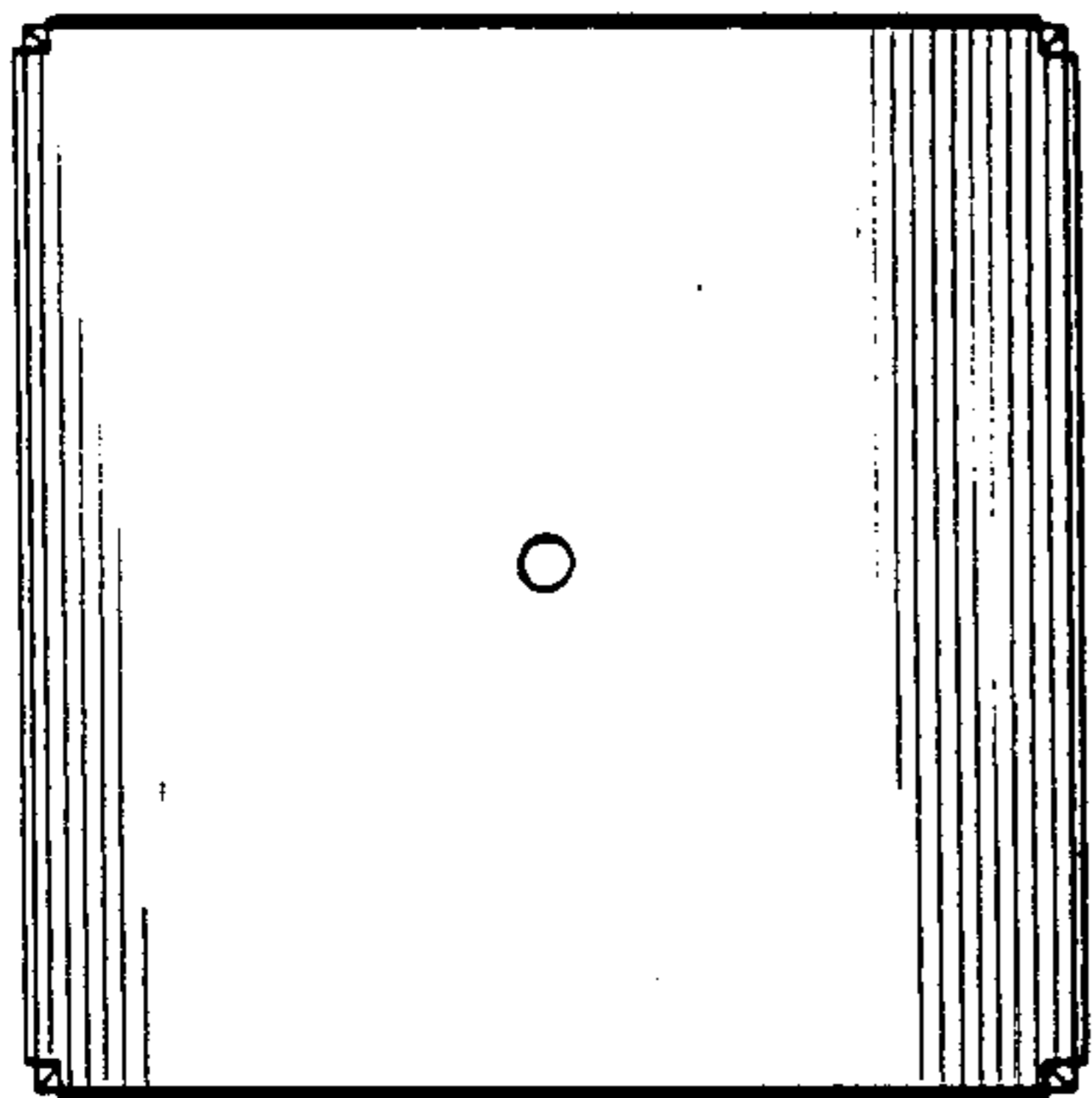
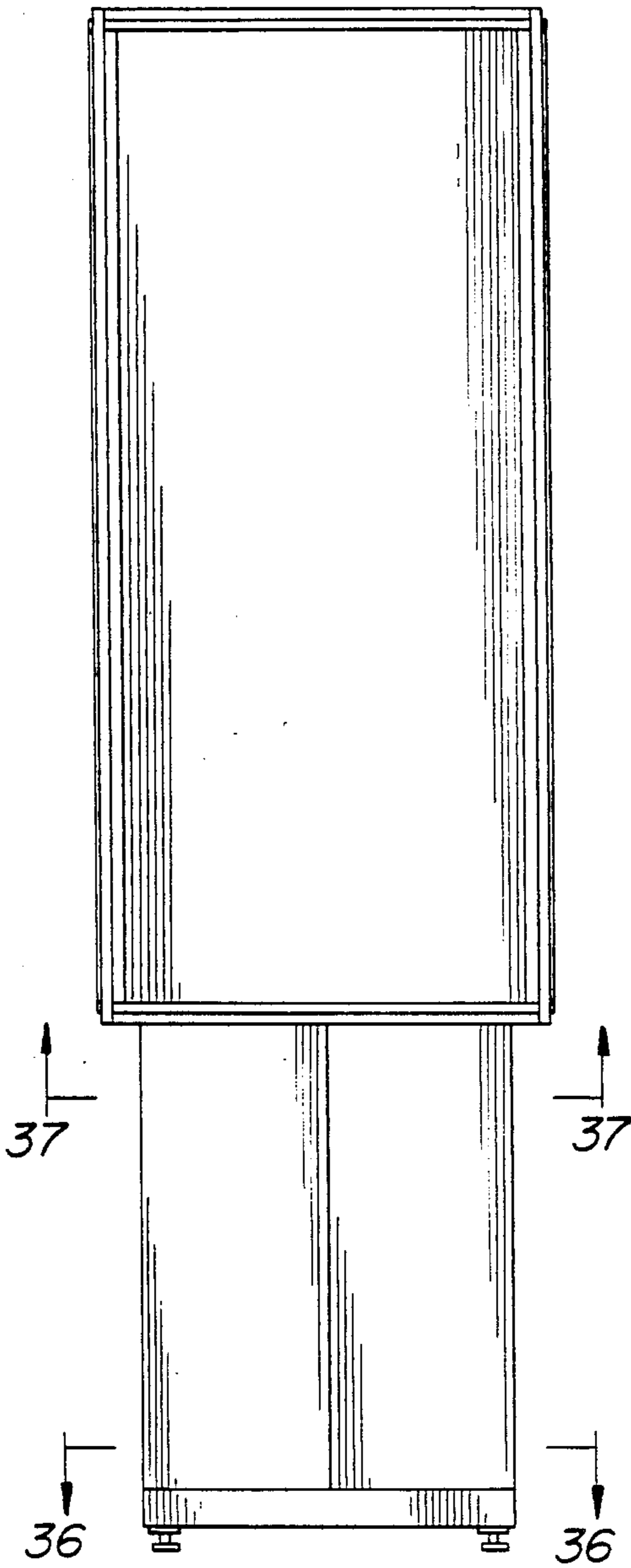
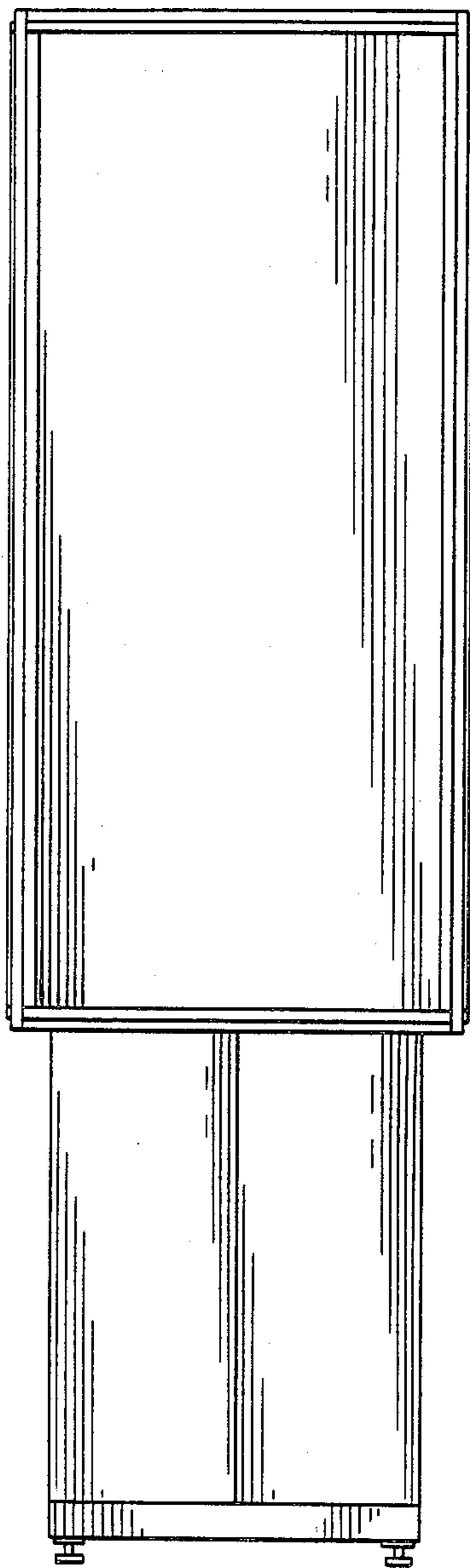


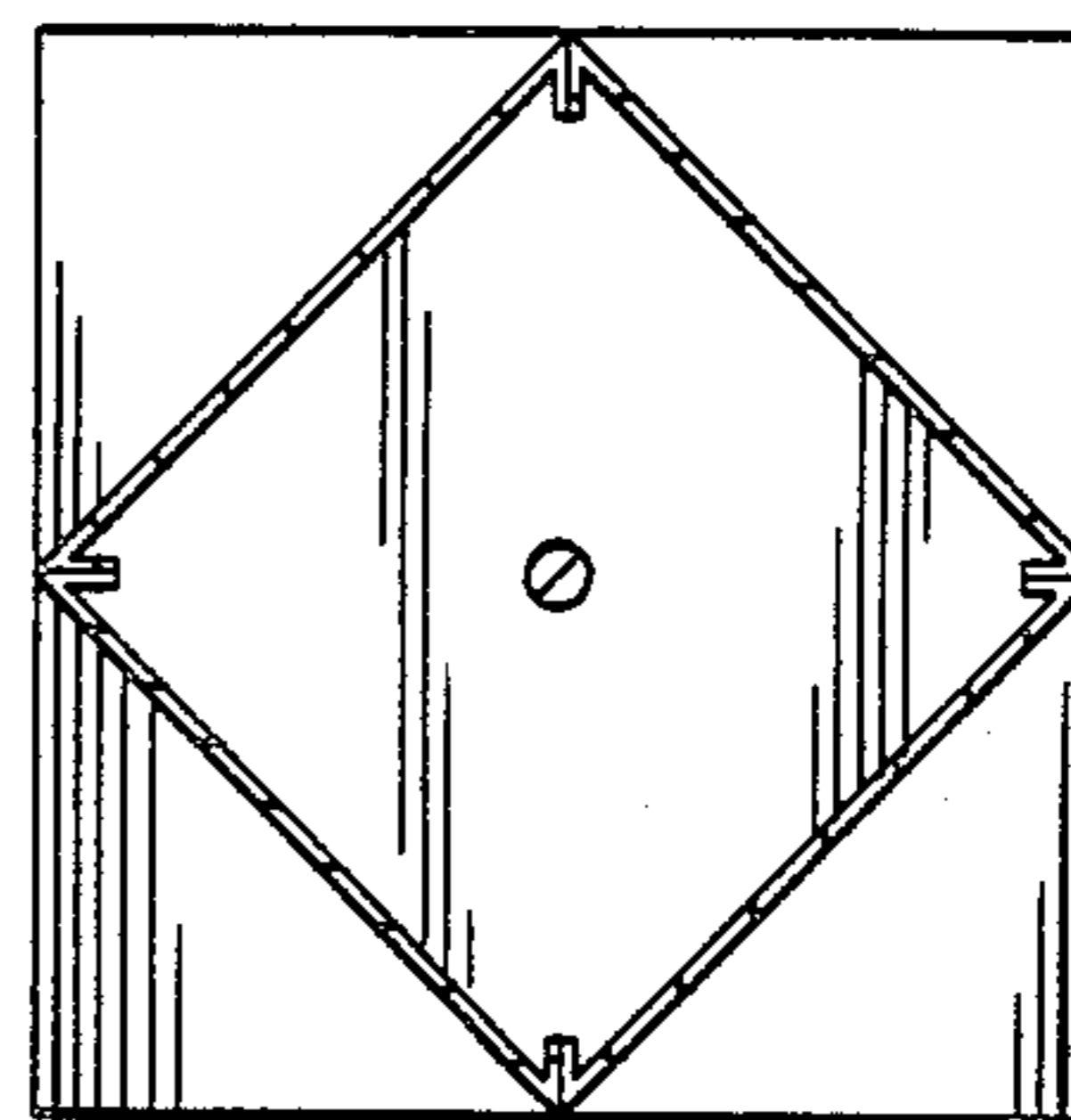
FIG. 33



*FIG. 35*



*FIG. 36*



*FIG. 37*

