

[54] PAINT SCRAPER FOR WINDOWS

[76] Inventor: Stephen B. Harvey, 1039 Pearl St., Santa Monica, Calif. 90405

[\*\*] Term: 14 Years

[21] Appl. No.: 886,116

[22] Filed: Jul. 16, 1986

[52] U.S. Cl. .... D32/49

[58] Field of Search ..... D32/40, 46-49; 15/236; 30/169, 171, 172

[56] References Cited

U.S. PATENT DOCUMENTS

D. 286,457	10/1986	Thomas	.....	D32/49
875,435	12/1907	Johnston	.....	30/169
1,926,944	9/1933	Hester	.....	30/169
3,571,838	3/1971	Stasechke	.....	15/236 R
4,531,254	7/1985	Abrahamisen	.....	15/236 R

FOREIGN PATENT DOCUMENTS

905207 4/1945 France ..... 15/236 R

Primary Examiner—Catherine E. Kemper  
Attorney, Agent, or Firm—Cislo & Thomas

[57] CLAIM

The ornamental design for a paint scraper for windows, as shown and described.

DESCRIPTION

FIG. 1 is a perspective view of a paint scraper for windows showing my new design;  
FIG. 2 is a top plan view thereof;  
FIG. 3 is a bottom plan view thereof;  
FIG. 4 is a left side elevational view thereof;  
FIG. 5 is a right side elevational view thereof;  
FIG. 6 is a rear elevational view thereof;  
FIG. 7 is a front elevational view thereof; and  
FIG. 8 is a fragmentary top plan view of a second embodiment of a paint scraper for windows, which differs from the first embodiment only in the configuration of the blade.

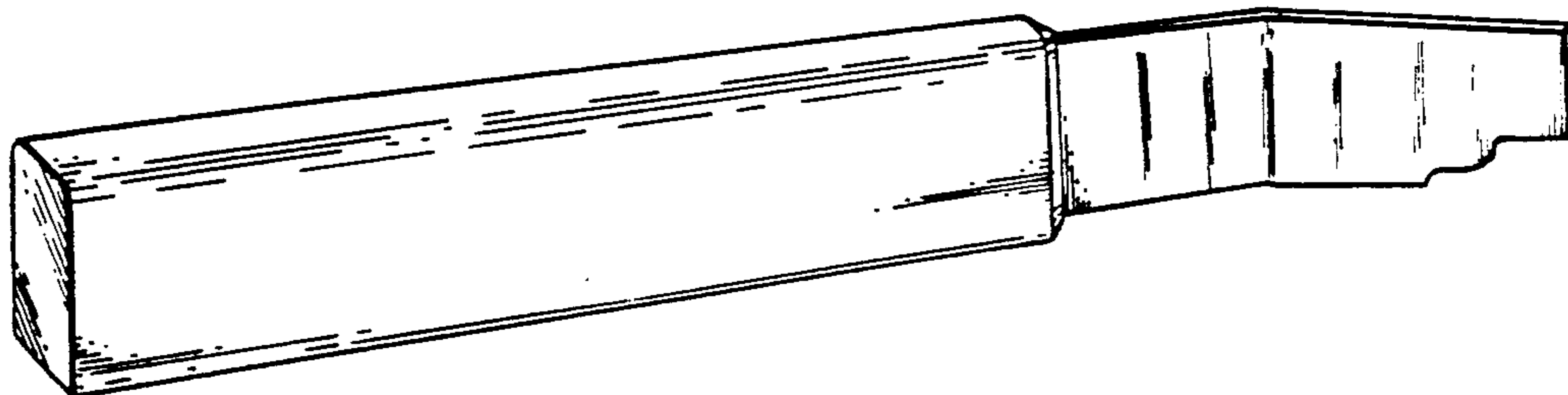

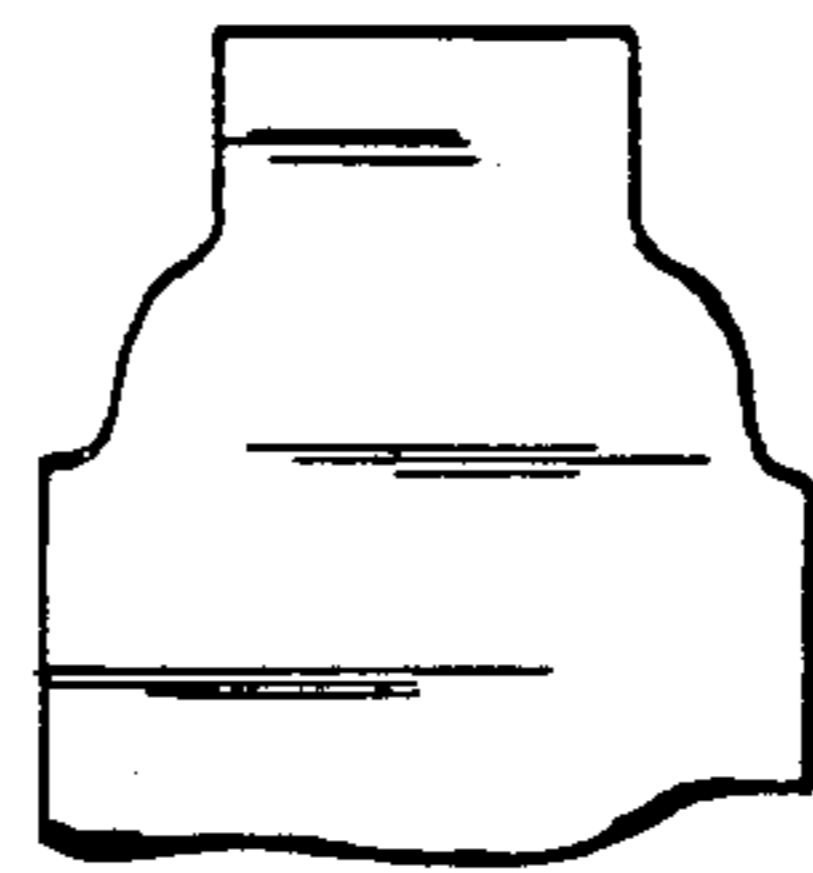
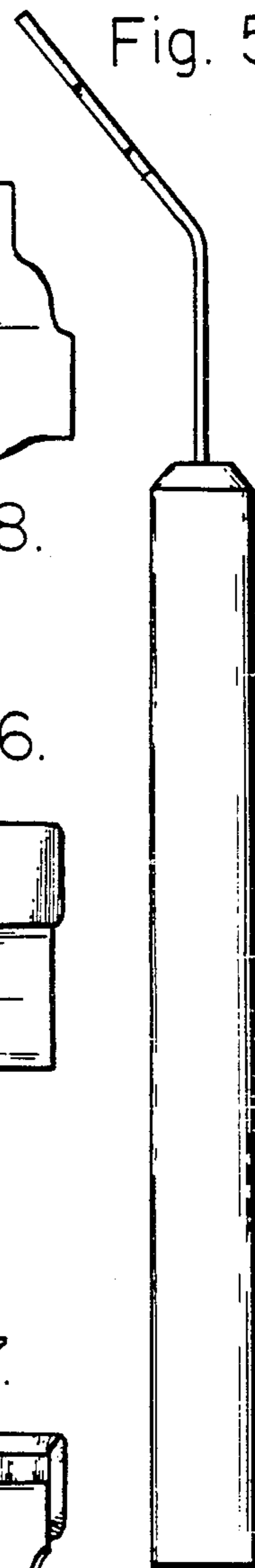
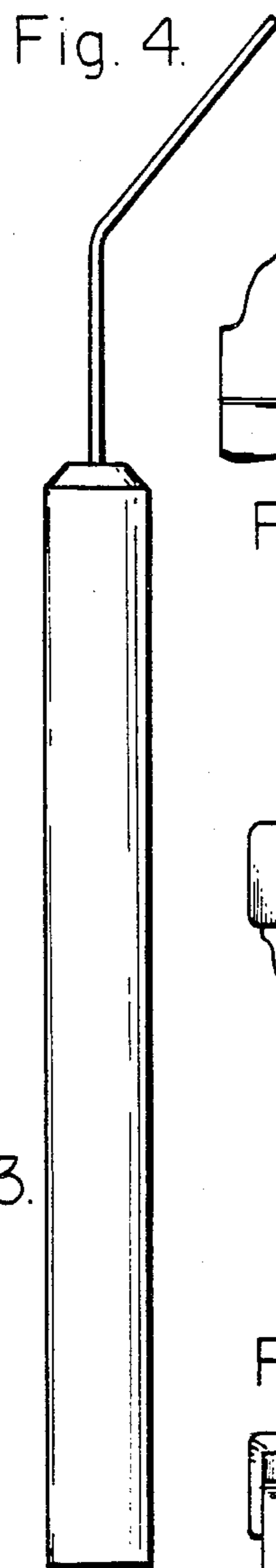
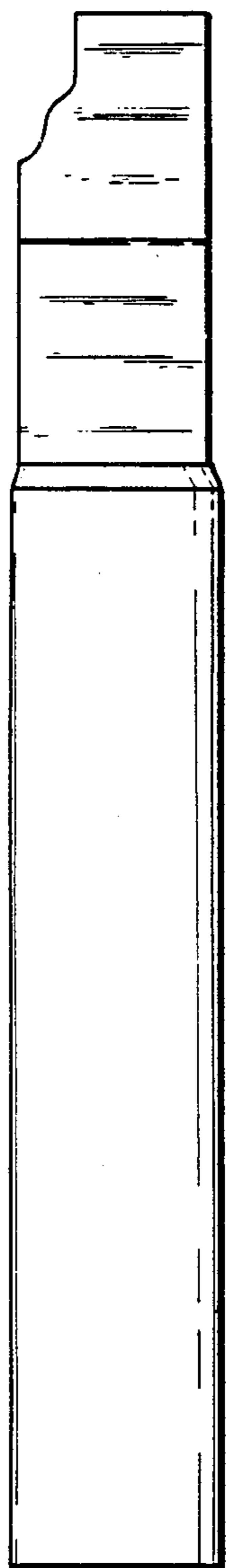
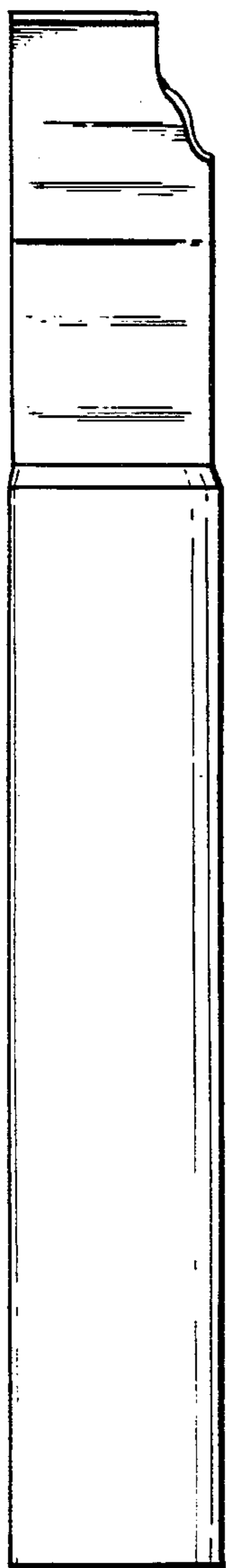
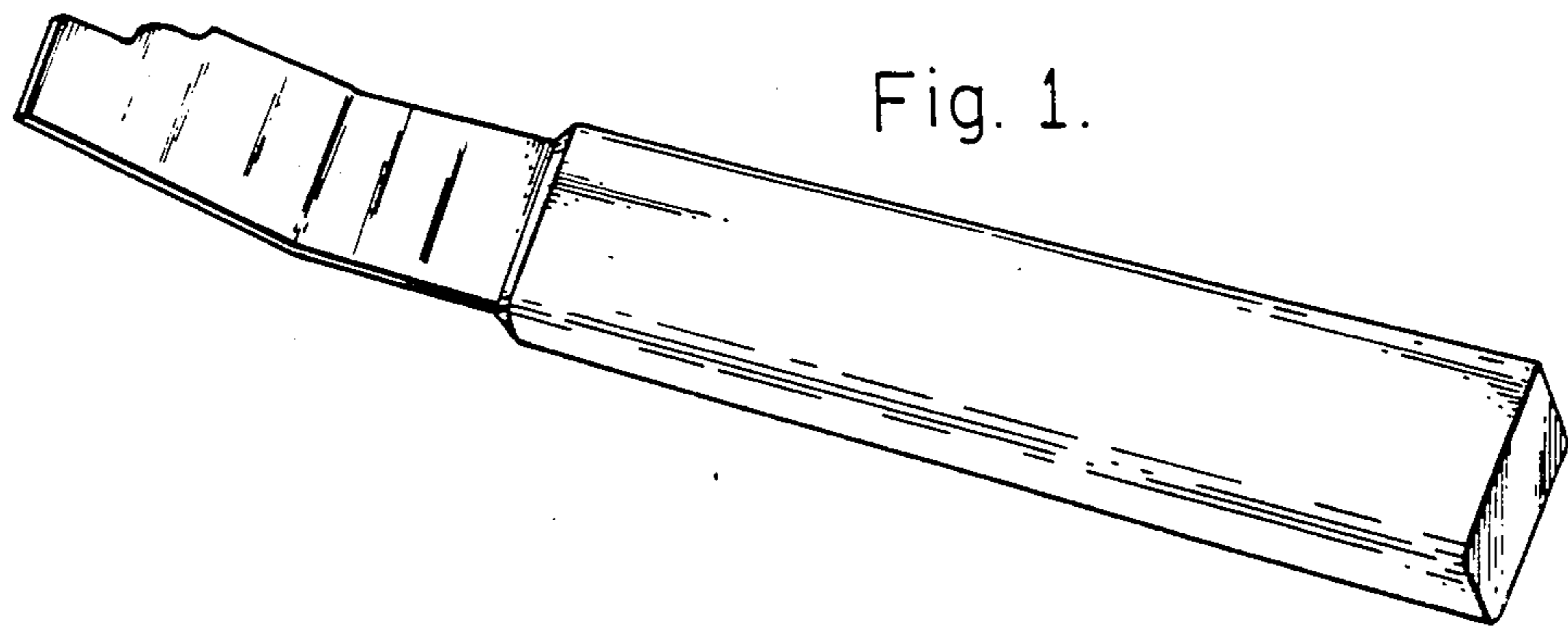

Fig. 8.

Fig. 6.



Fig. 7.

