

[54] FACSIMILE MACHINE
 [75] Inventor: Yoshihisa Ooie, Osaka, Japan
 [73] Assignee: Sharp Corporation, Osaka, Japan
 [**] Term: 14 Years
 [21] Appl. No.: 750,410
 [22] Filed: Jun. 28, 1985

[30] Foreign Application Priority Data
 Jan. 10, 1985 [JP] Japan 60-601
 [52] U.S. Cl. D14/94; D16/31
 [58] Field of Search D14/94, 99; D16/27,
 D16/30, 31, 32; 358/256, 285, 286

[56] References Cited
 U.S. PATENT DOCUMENTS
 D. 268,582 4/1983 Kikuchi D14/94
 D. 281,256 11/1985 Yamamoto D16/31 X
 D. 282,365 1/1986 Hayashida D16/31 X
 D. 288,444 2/1987 Takeuchi et al. D16/31 X

D. 289,048 3/1987 Kojima D14/94

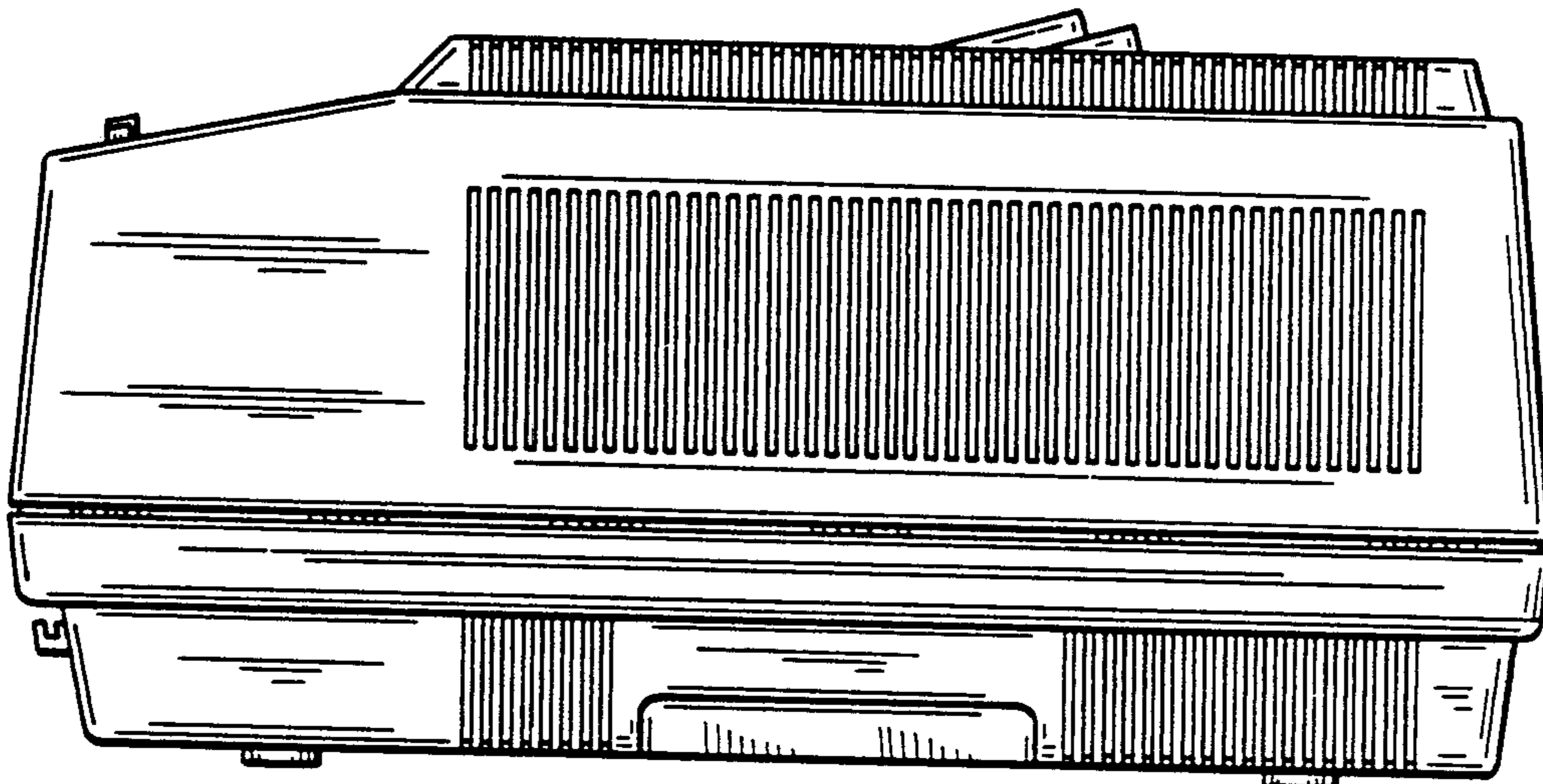
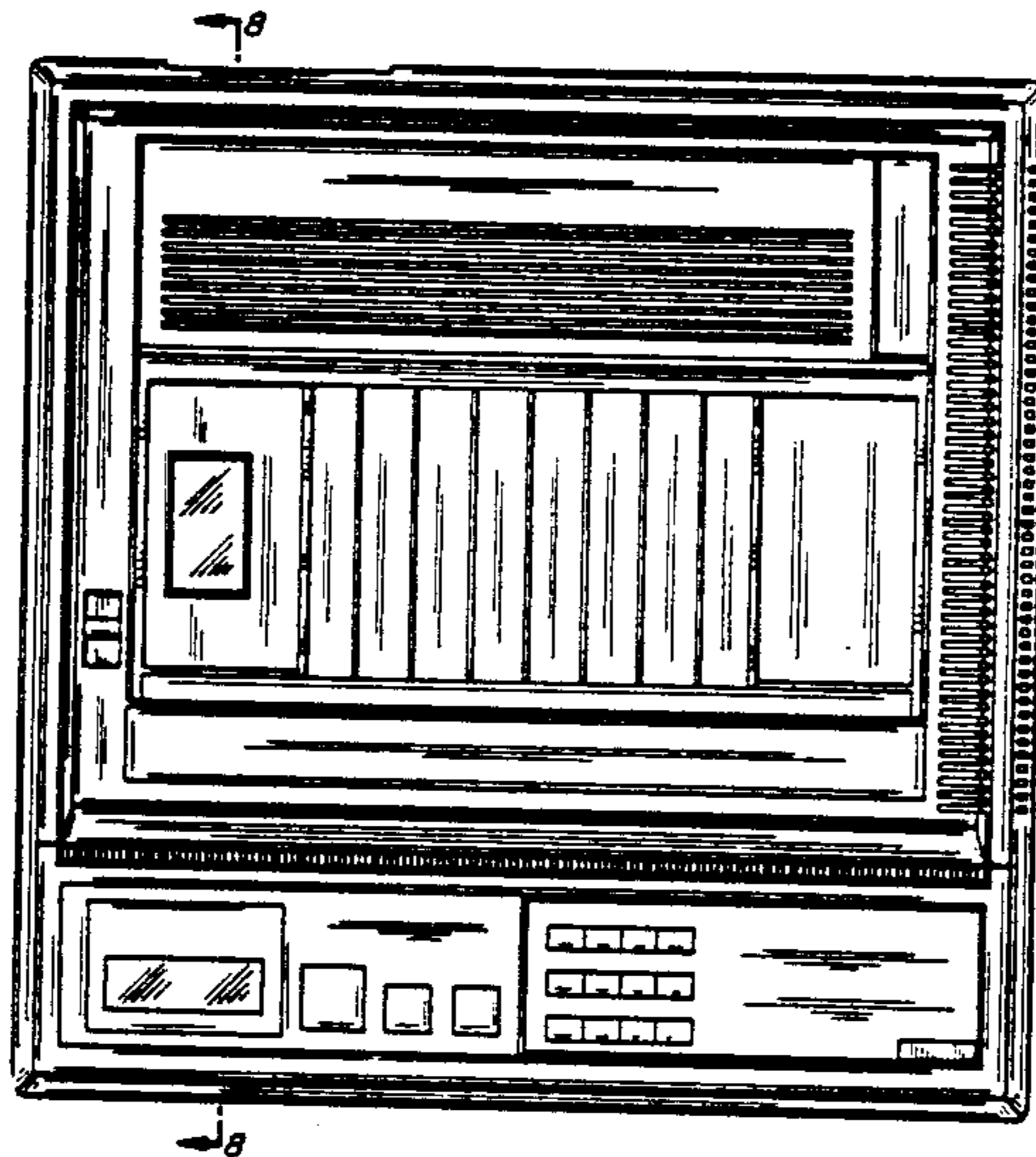
Primary Examiner—Bernard Ansher
 Assistant Examiner—Theodore M. Shooman
 Attorney, Agent, or Firm—Flehr, Hohbach, Test,
 Albritton & Herbert

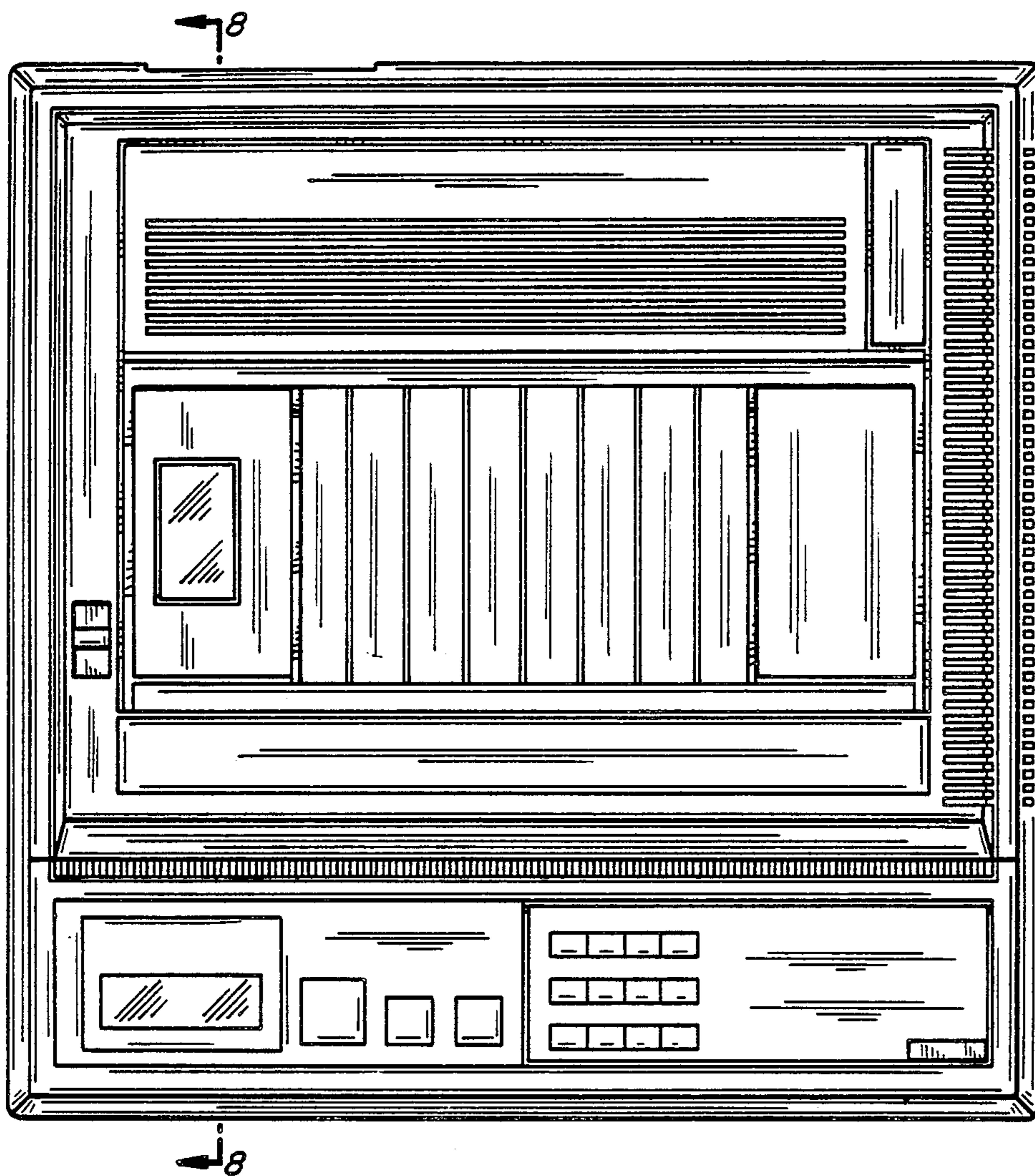
[57] CLAIM

The ornamental design for a facsimile machine, as shown and described.

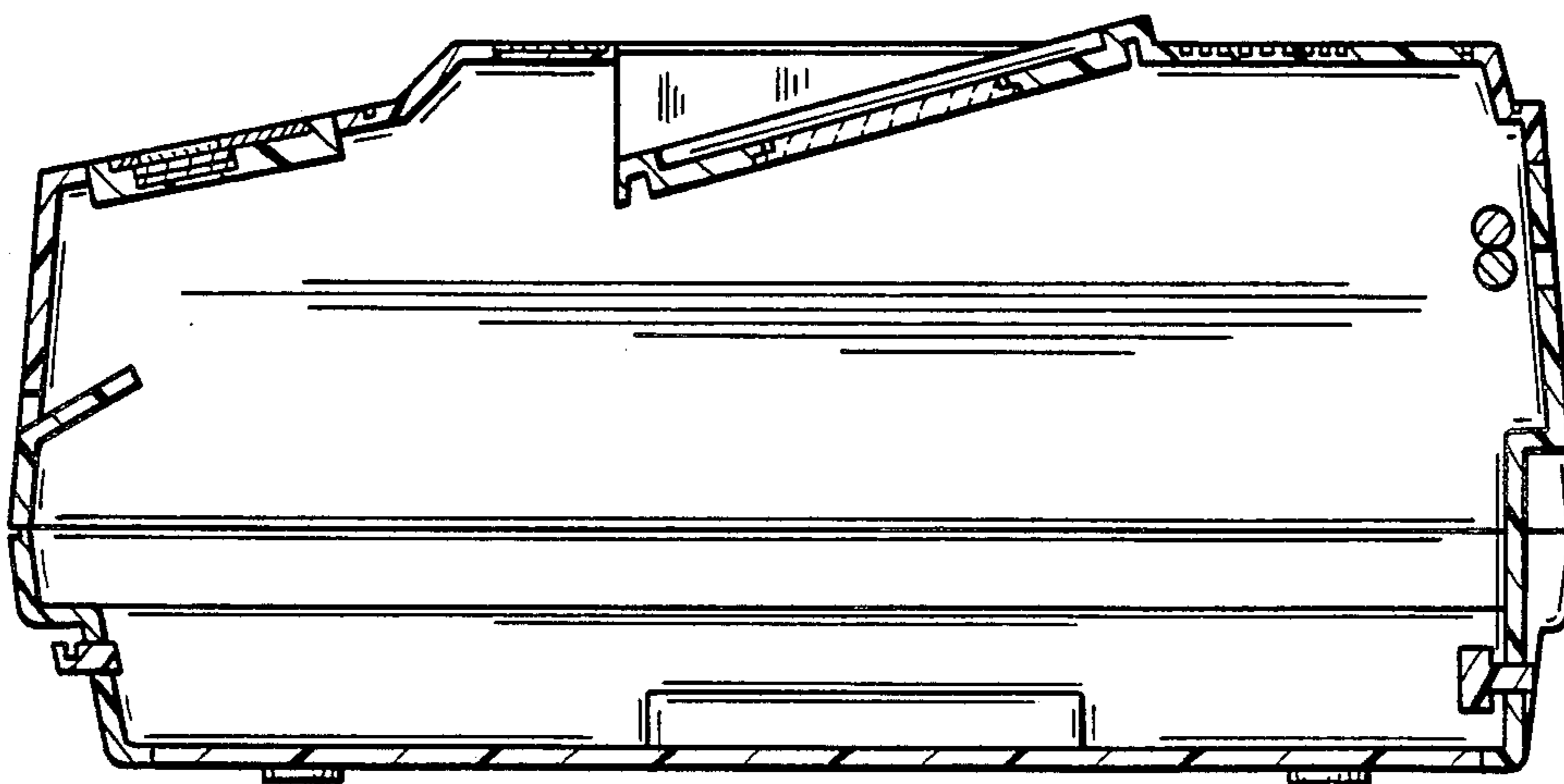
DESCRIPTION

FIG. 1 is a top plan view of the facsimile machine showing my new design;
 FIG. 2 is a top plan view thereof with the cover of the operating part open;
 FIG. 3 is a bottom plan view thereof;
 FIG. 4 is a front elevational view thereof;
 FIG. 5 is a rear elevational view thereof;
 FIG. 6 is a right side elevational view thereof;
 FIG. 7 is a left side elevational view thereof; and
 FIG. 8 is a sectional view thereof taken along the line 8—8 of FIG. 1.

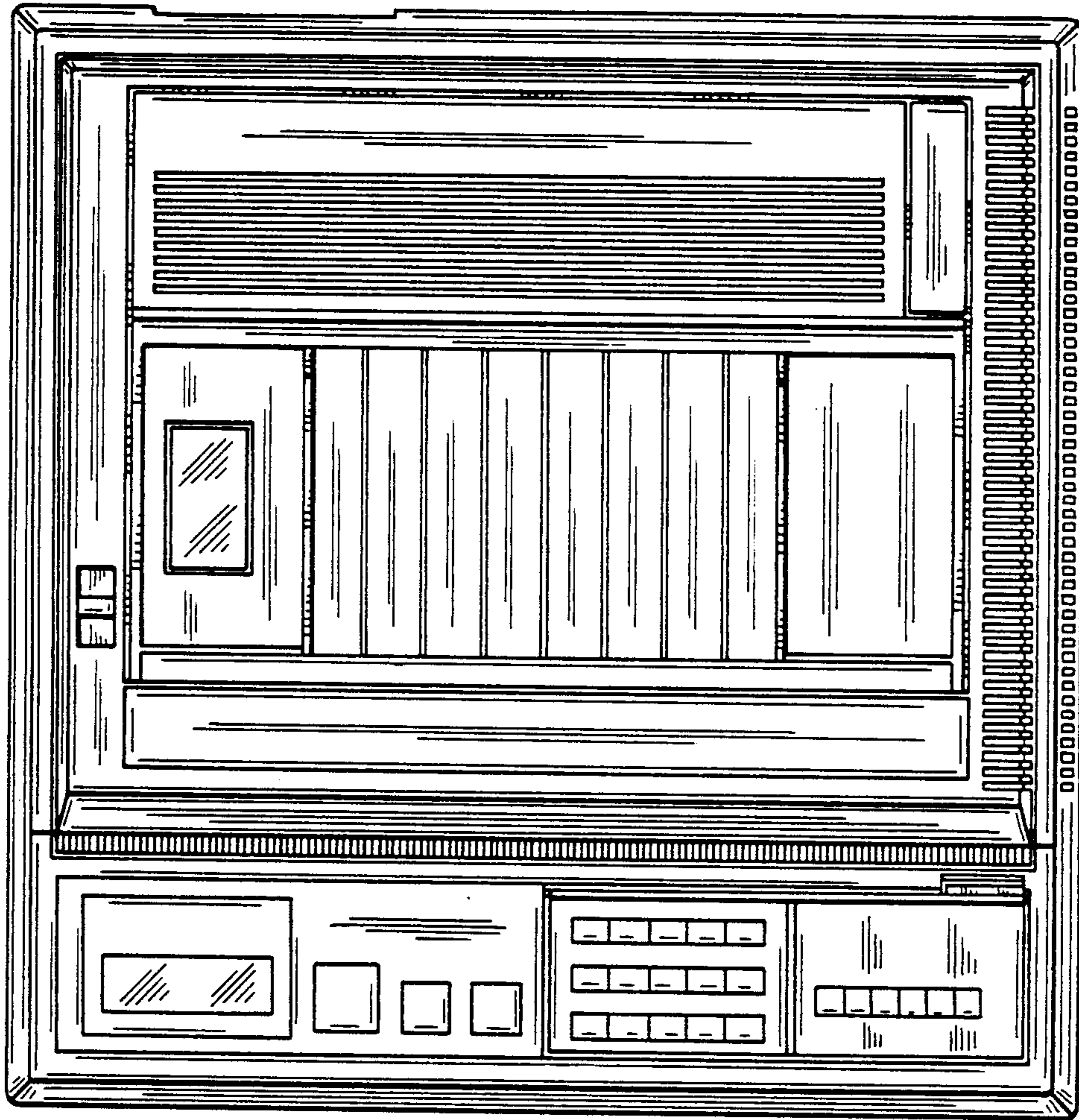




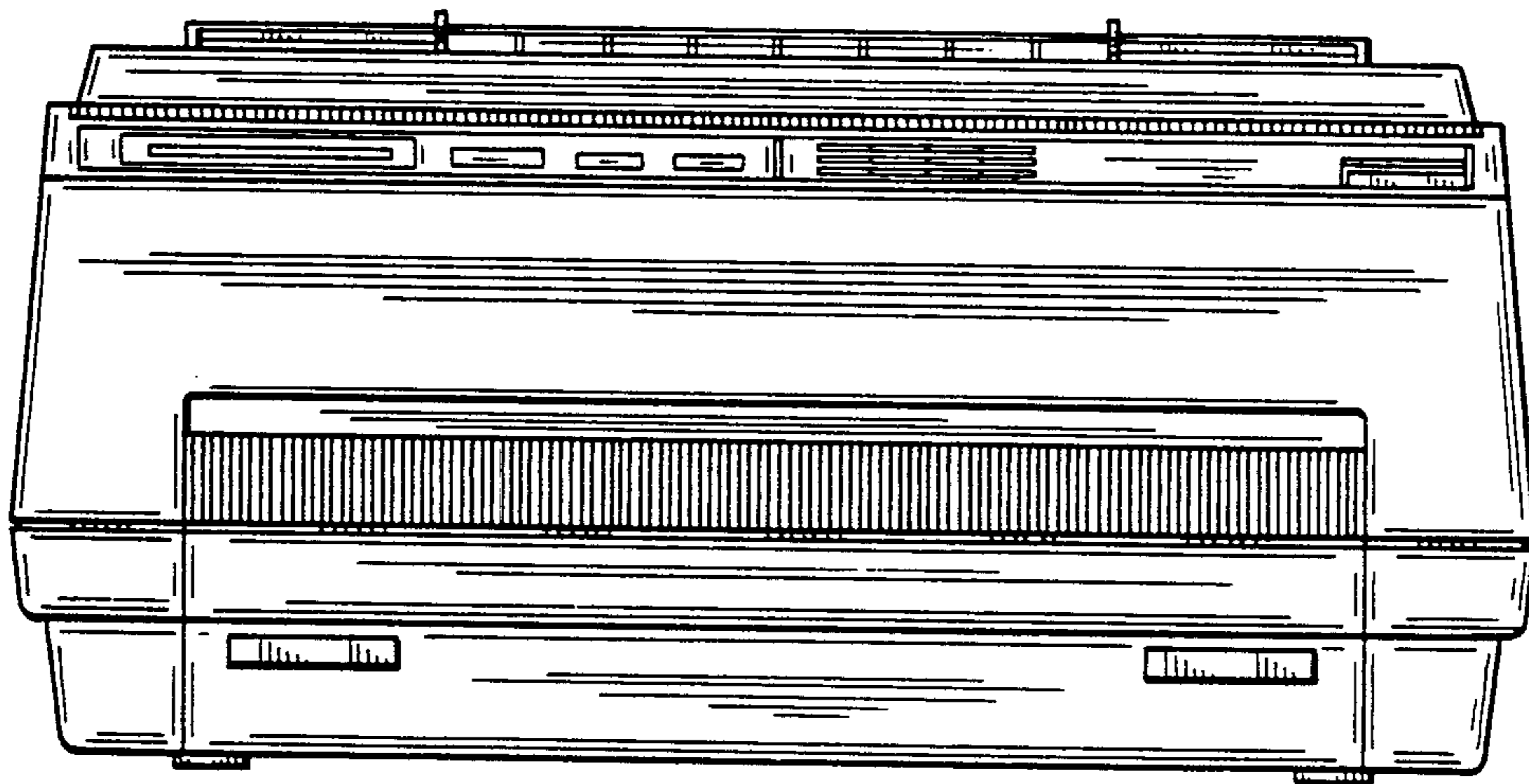
FIG_1



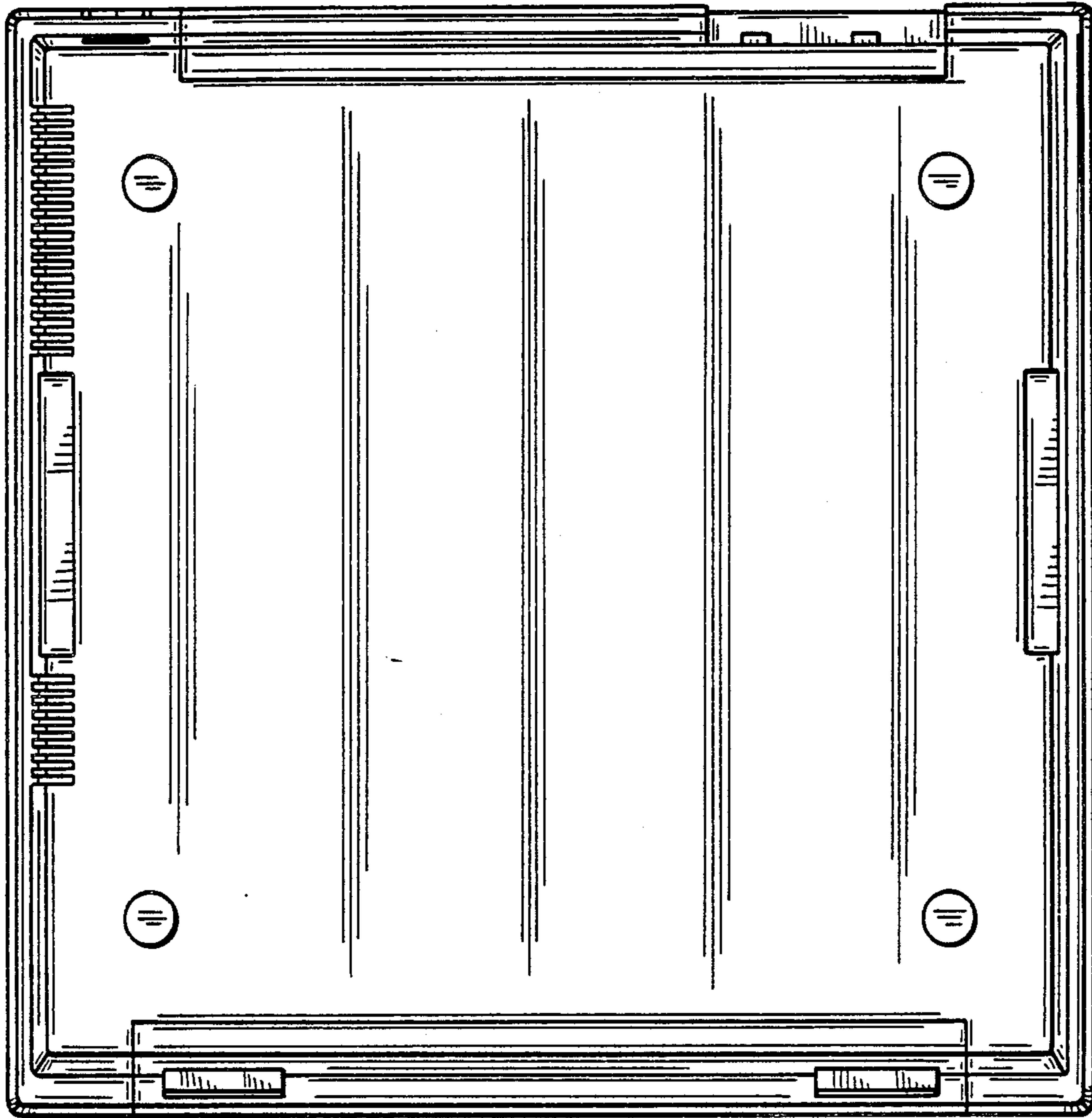
FIG_8



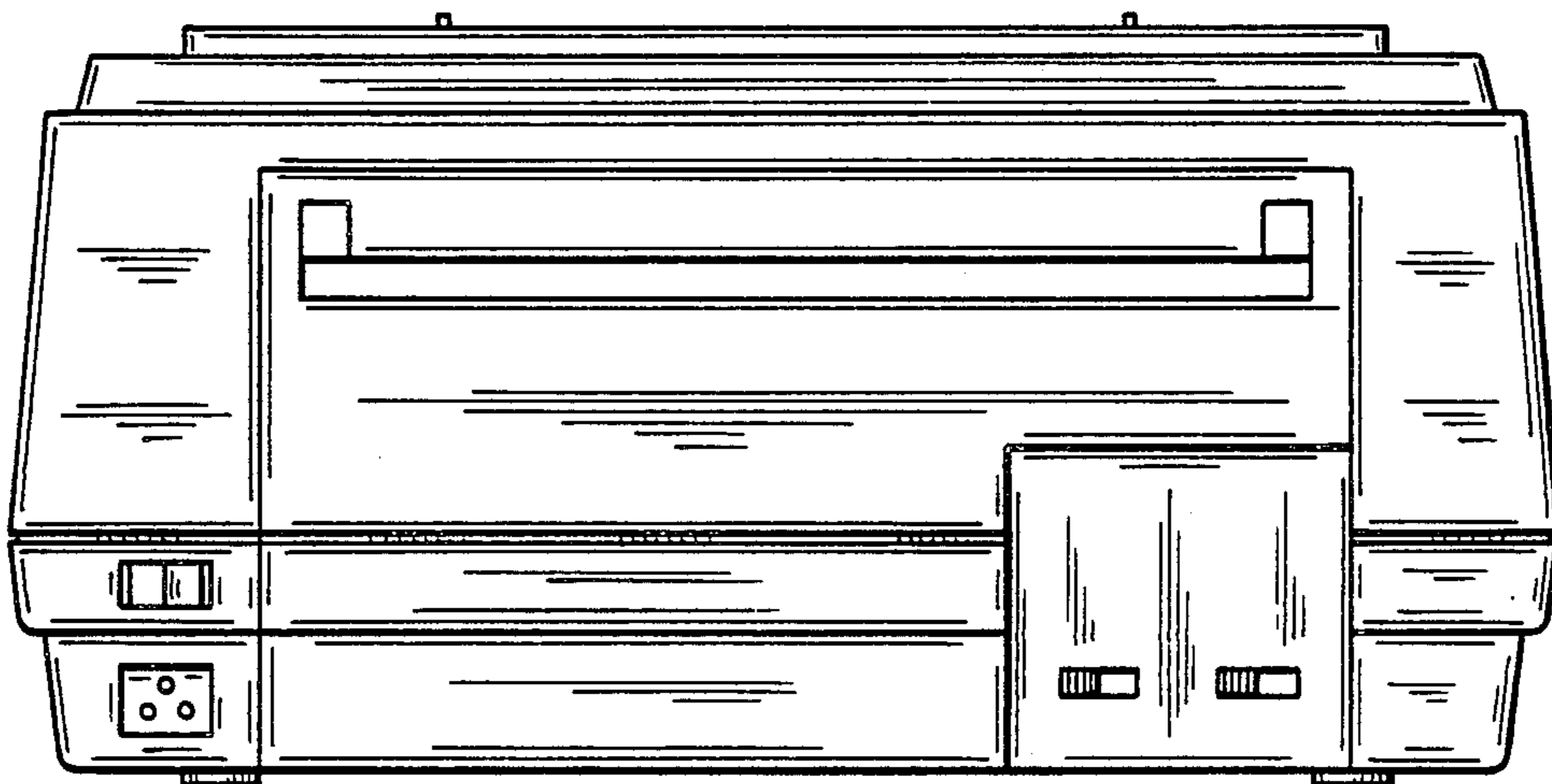
FIG_2



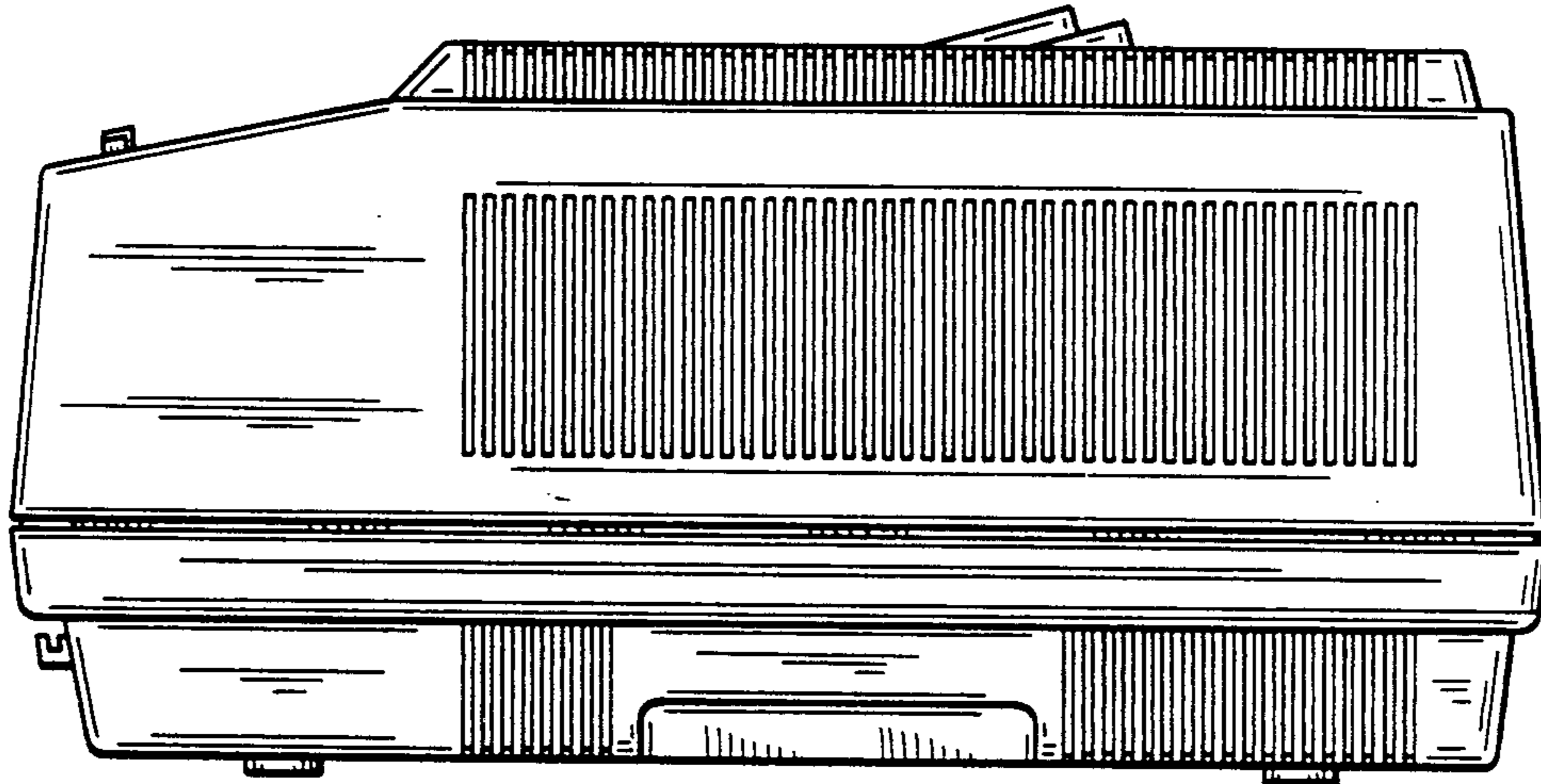
FIG_4



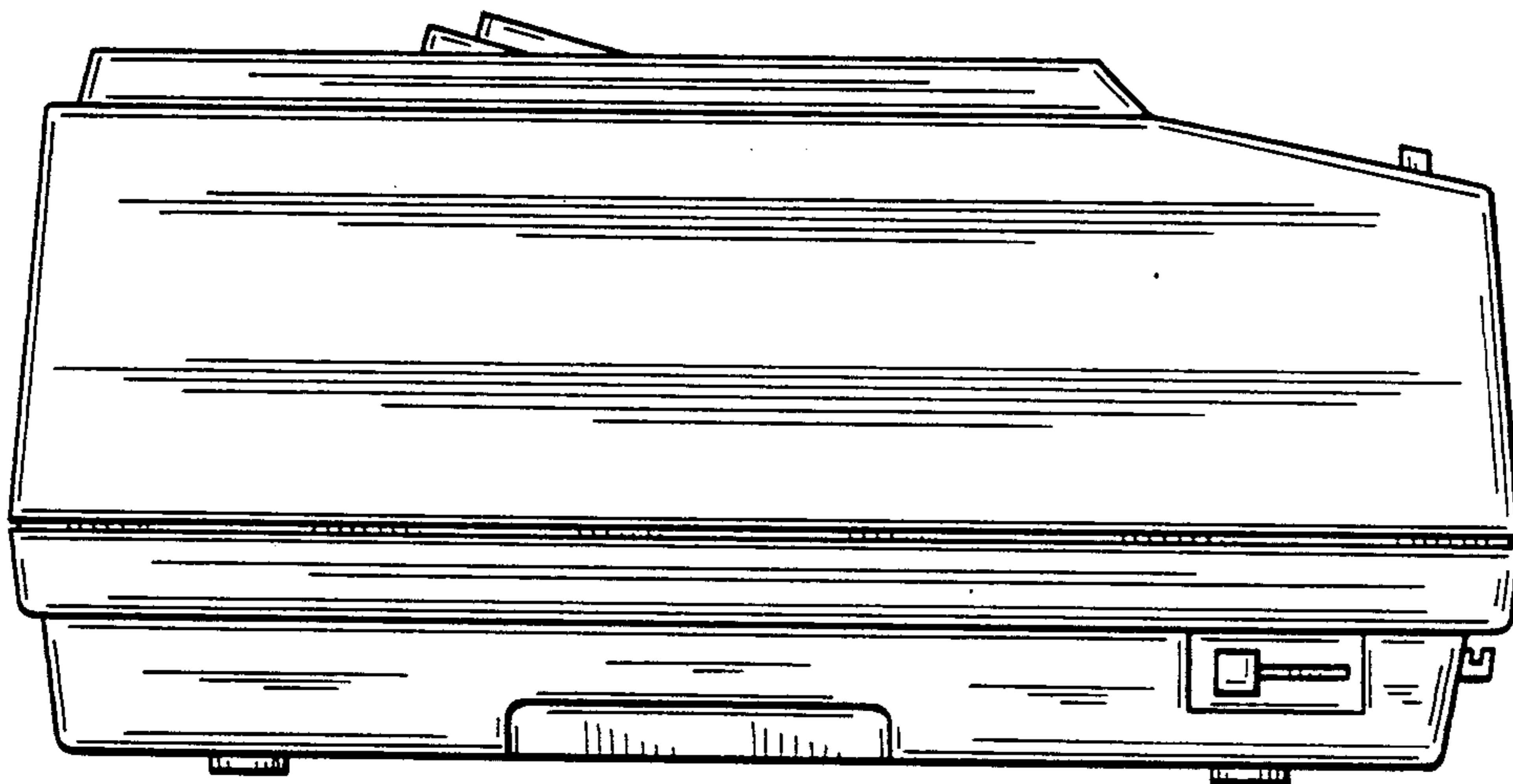
FIG_3



FIG_5



FIG_6



FIG_7