

[54] COSMETIC CONTAINER FOR NON-LIQUID COSMETICS

[75] Inventors: Ted I. Kingsford; Robert L. Baumgartner, both of Memphis, Tenn.

[73] Assignee: Plough, Inc., Memphis, Tenn.

[**] Term: 14 Years

[21] Appl. No.: 807,397

[22] Filed: Dec. 10, 1985

[52] U.S. Cl. D28/83; D28/76

[58] Field of Search D3/39; D9/341, 347, D9/337, 338, 420, 423, 424; D28/4-8, 38, 61, 73, 77-91.1; 206/581, 235, 385, 823; 220/DIG. 26; 132/1 R, 79 R-79 C, 79 F, 79 G, 83 R, 82 R-82 F, 83 B, 83 E-83 G

[56] References Cited

U.S. PATENT DOCUMENTS

D. 279,225 6/1985 Chevassus D28/83

D. 280,450 9/1985 Schefer D28/78
4,421,127 12/1983 Geer 206/235

Primary Examiner—Louis S. Zarfes
Attorney, Agent, or Firm—Gerald S. Rosen; Thomas D. Hoffman; Stephen I. Miller

[57] CLAIM

The ornamental design for a cosmetic container for non-liquid cosmetics, substantially as shown and described.

DESCRIPTION

FIG. 1 is a top plan view of a cosmetic container for non-liquid cosmetics in closed position showing our new design.

FIG. 2 is a top plan view thereof in open position.

FIG. 3 is side view thereof in closed position.

FIG. 4 is side elevational view thereof in open position.

FIG. 5 is a front elevational view thereof in closed position.

FIG. 6 is a bottom plan view thereof.

FIG. 7 is a rear elevational view thereof in closed position.

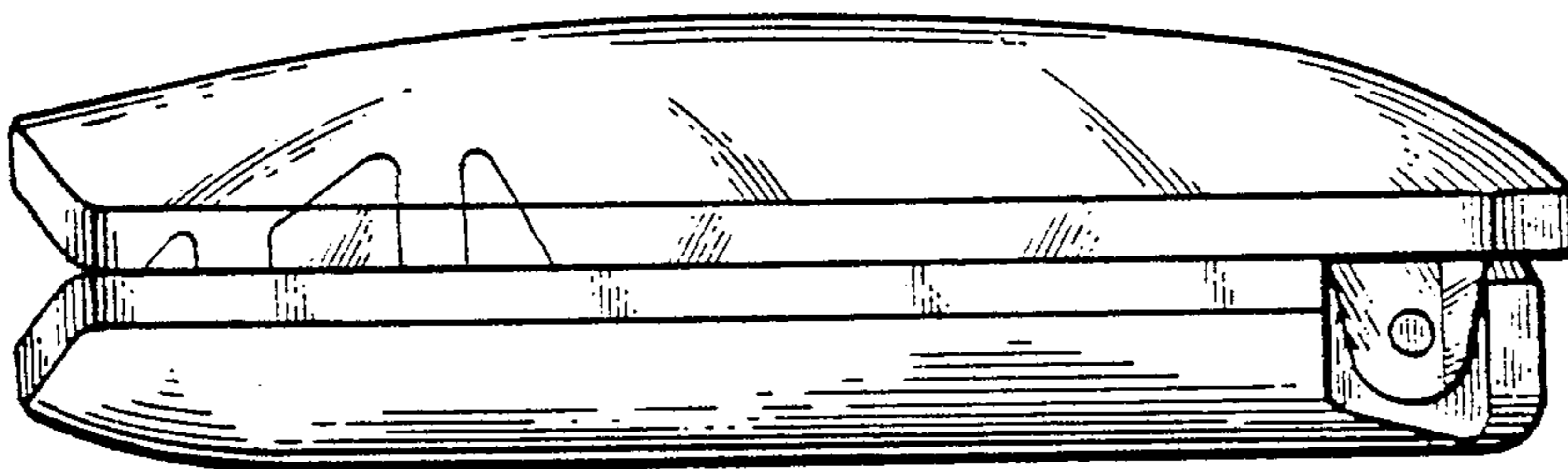
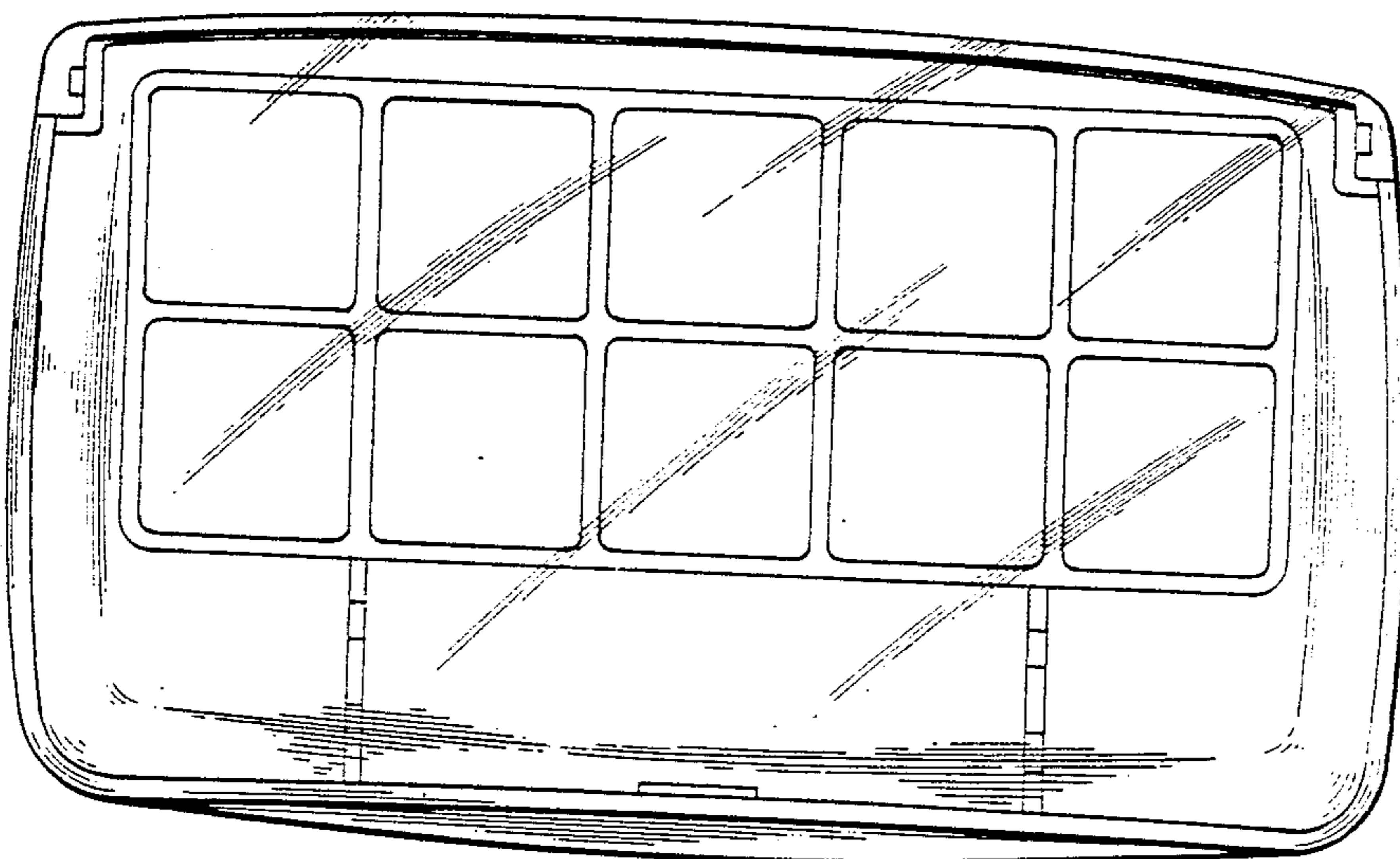

FIG. 1

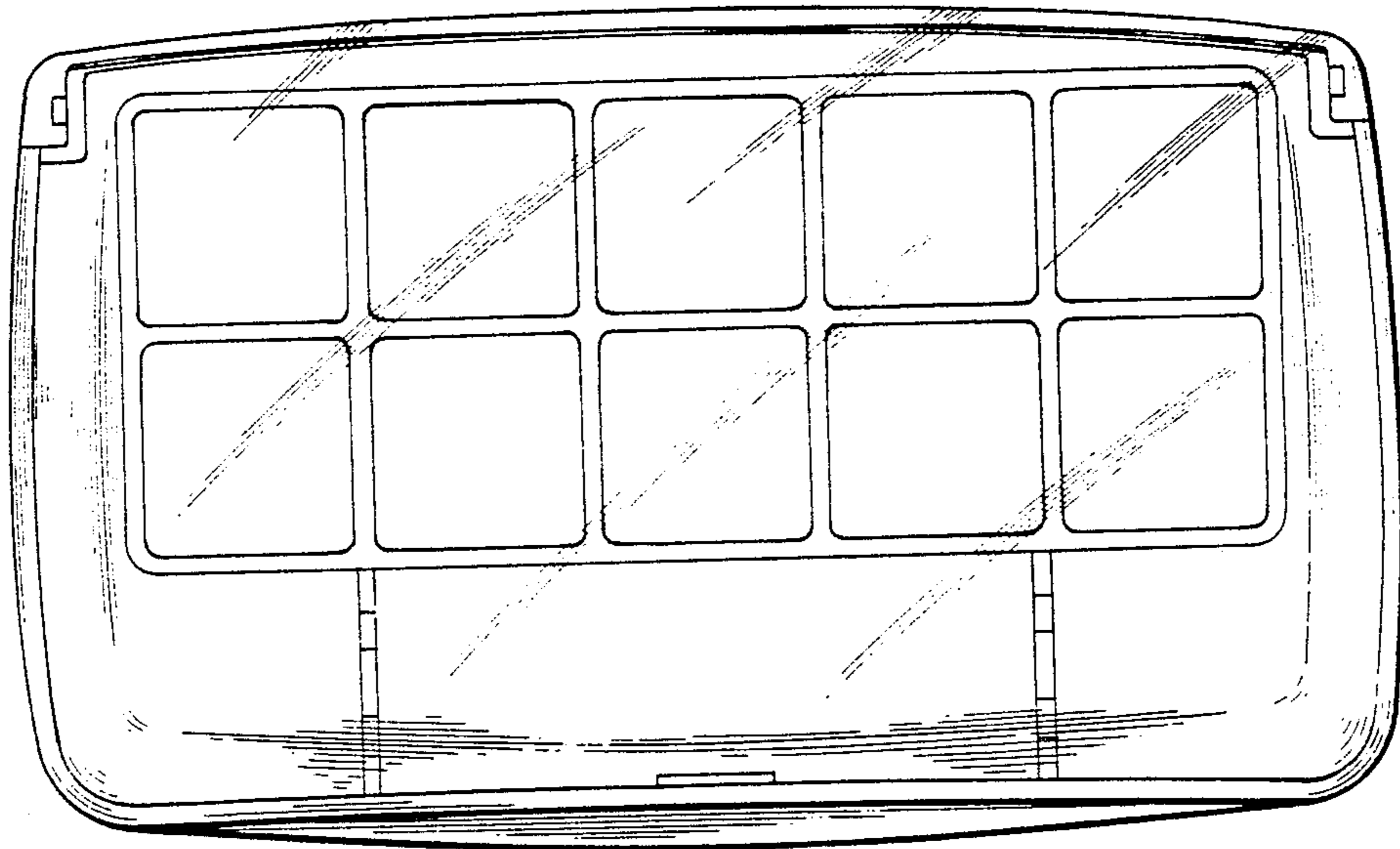

FIG. 2

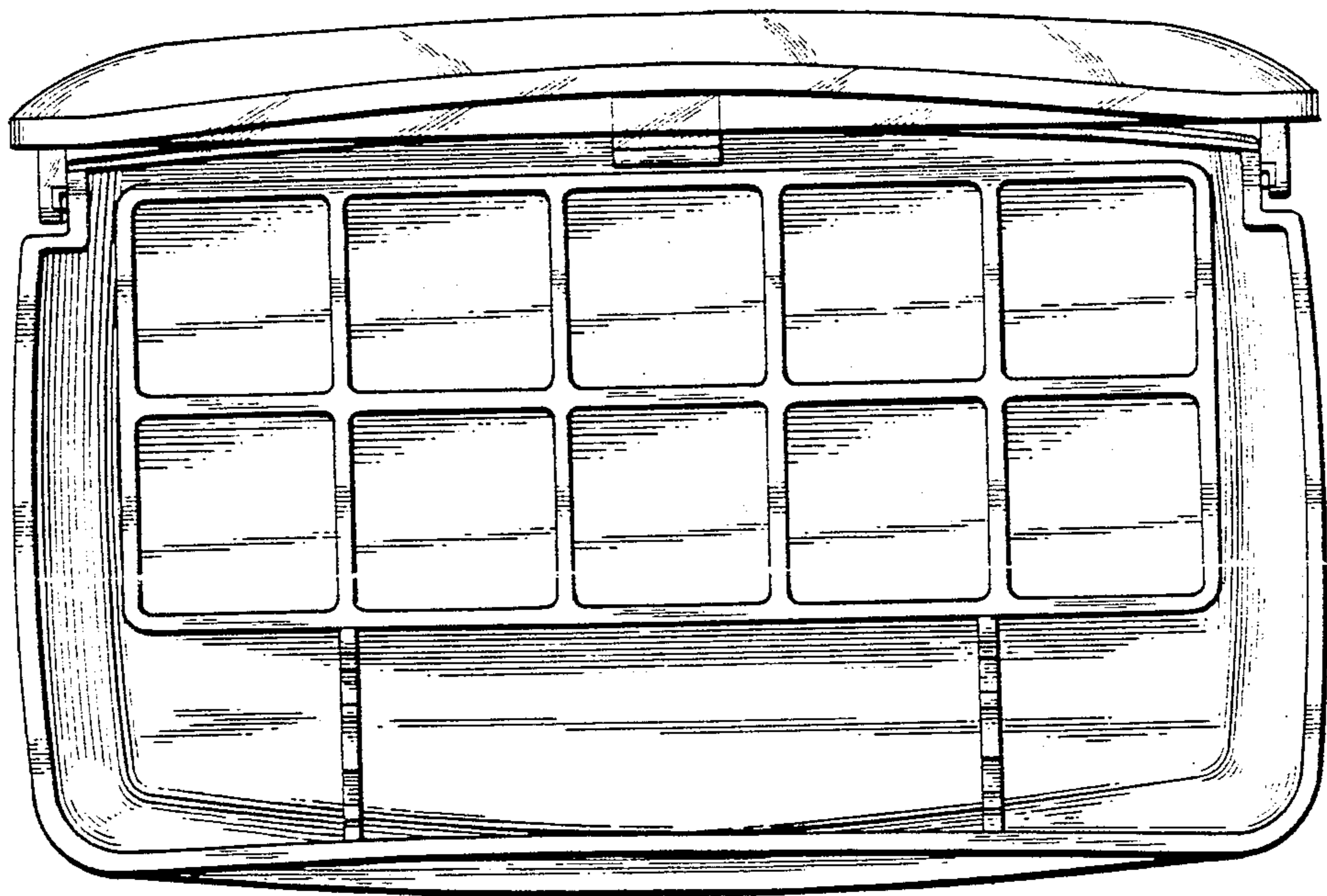

FIG. 3

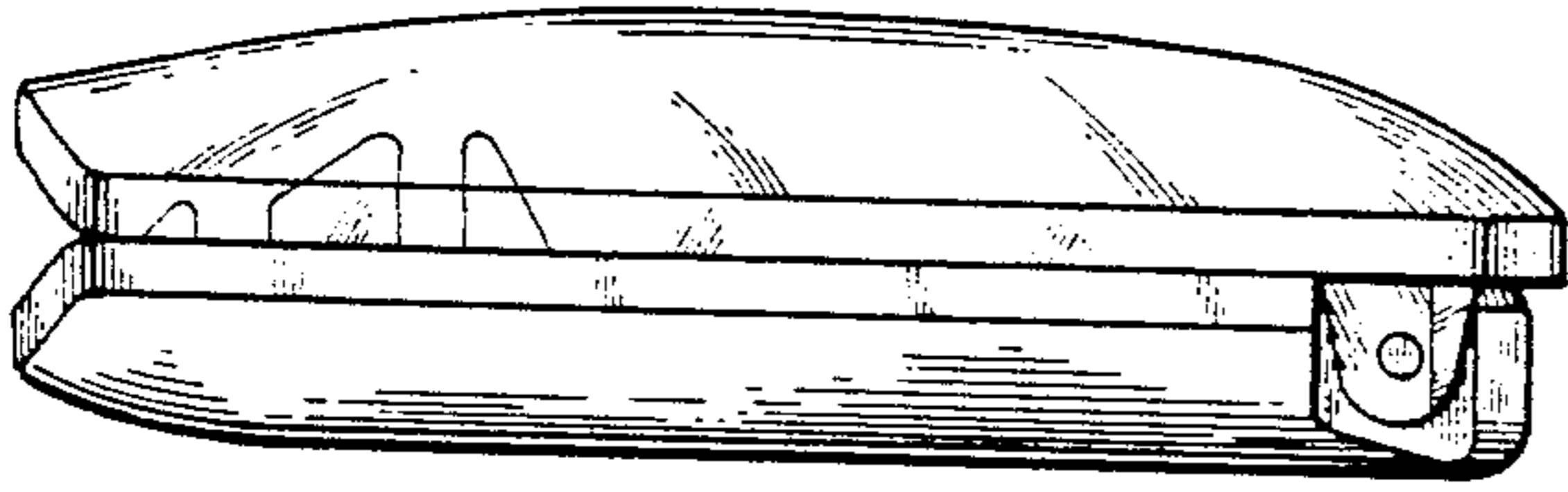

FIG. 4

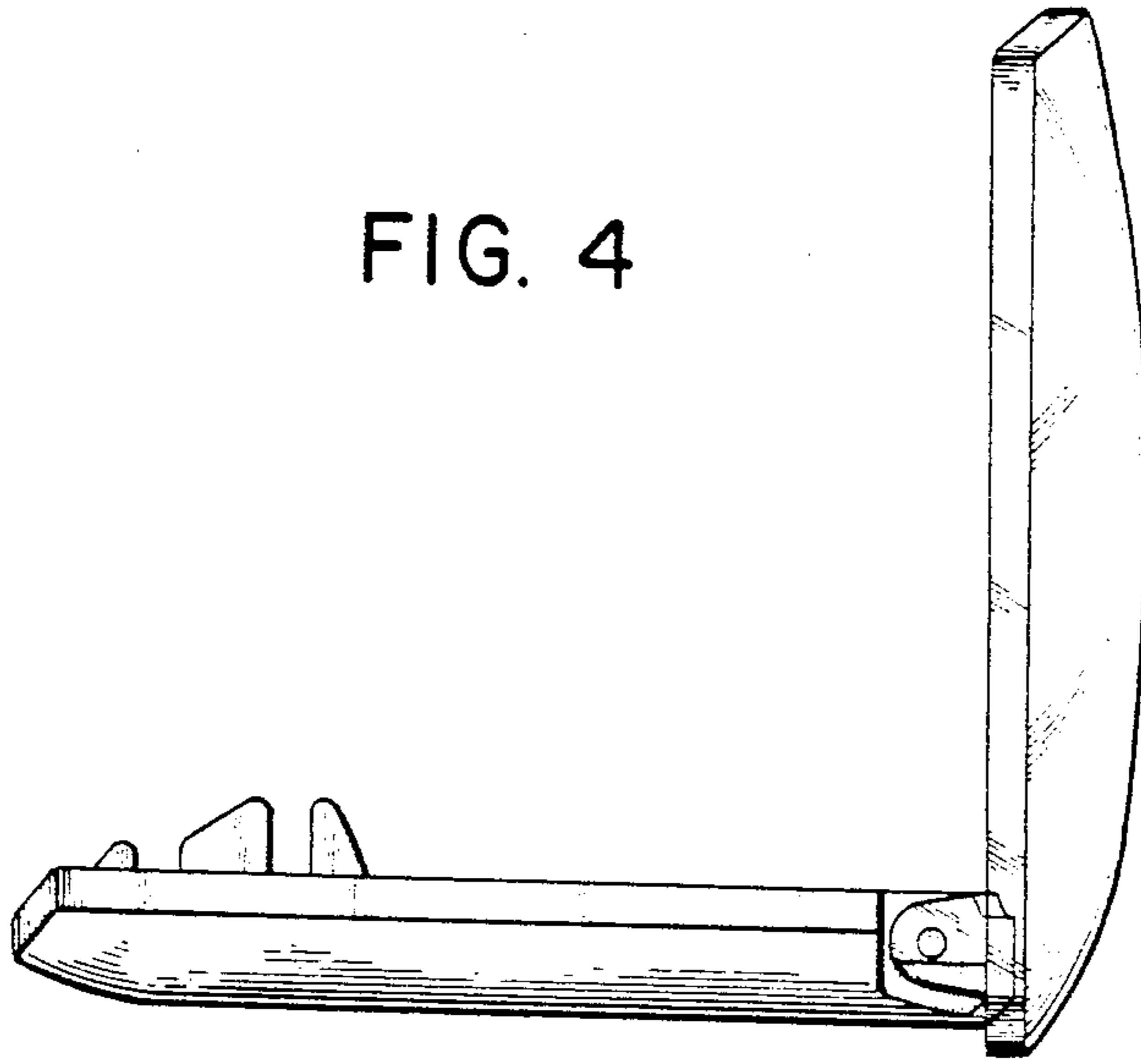

FIG. 5

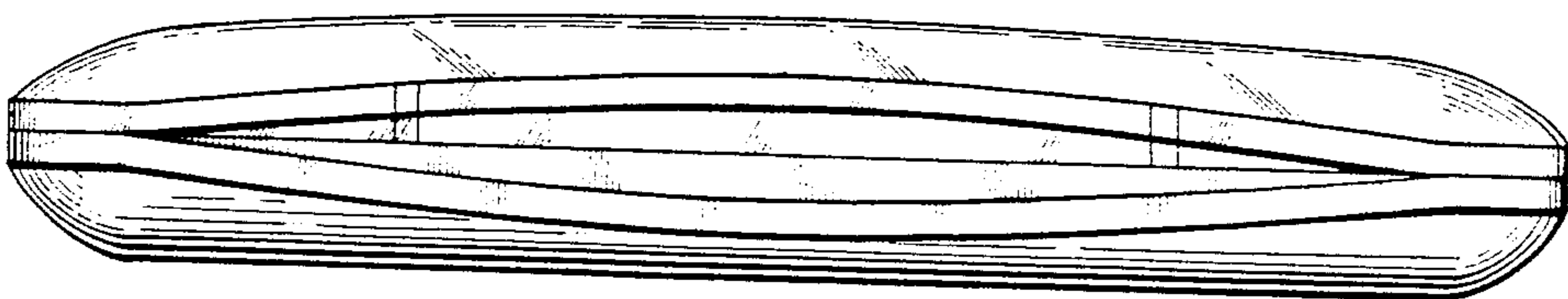

FIG. 6

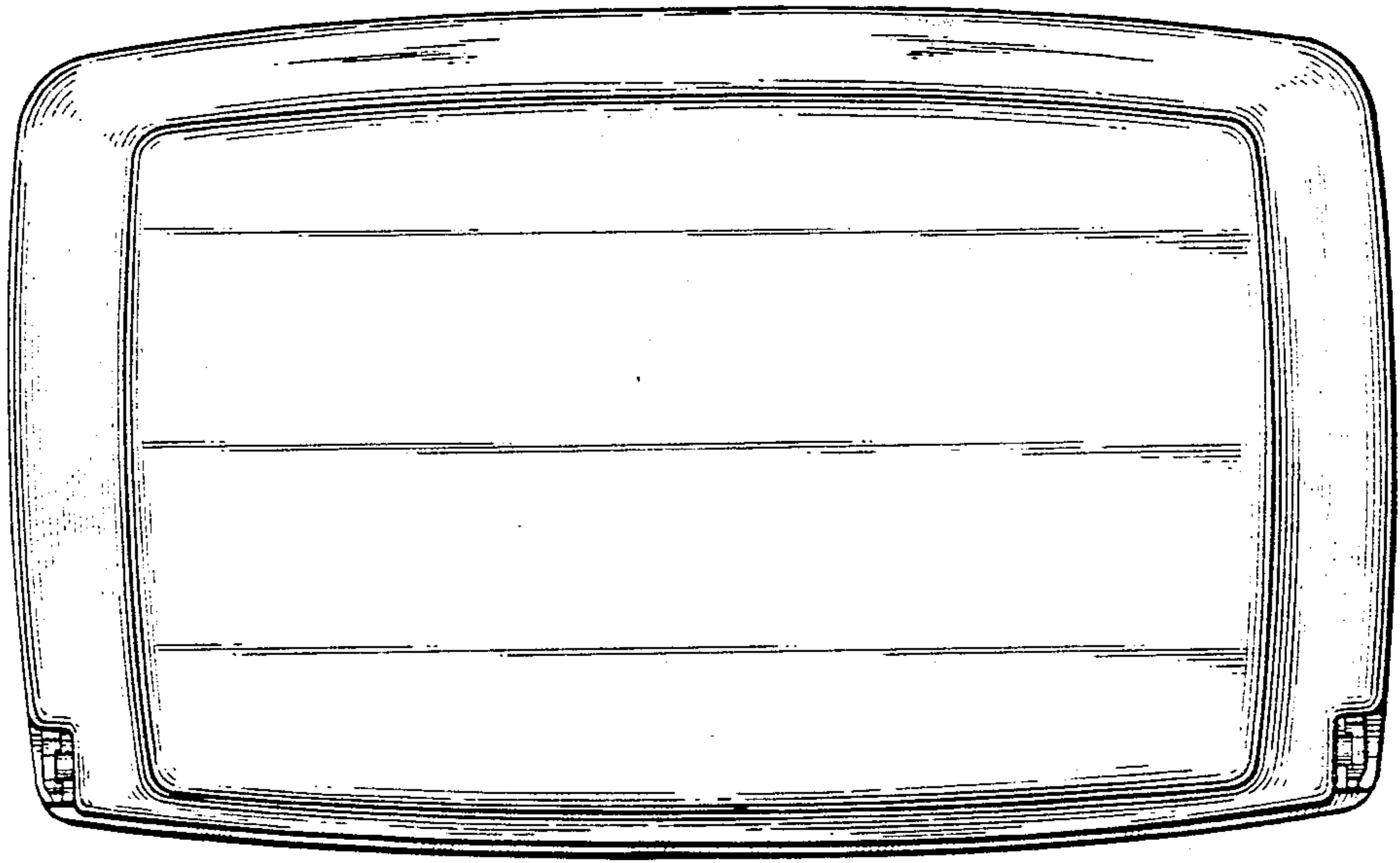

FIG. 7

