

United States Patent [19]

Rigoli

[11] Patent Number: Des. 293,646

[45] Date of Patent: ** Jan. 12, 1988

[54] HANDLE FOR A POT

[75] Inventor: Raniero Rigoli, Ciampino, Italy

[73] Assignee: RISA W.M.C. s.r.l., Albano Laziale, Italy

[**] Term: 14 Years

[21] Appl. No.: 696,189

[22] Filed: Jan. 29, 1985

[52] U.S. Cl. D7/393

[58] Field of Search D7/394, 393, 360

[56] References Cited

U.S. PATENT DOCUMENTS

D. 183,124 7/1958 Hampshire D7/360
D. 187,943 5/1960 Eckersberg et al. D7/394
D. 212,379 10/1968 Dudas et al. D7/393

D. 252,311 7/1979 Prussi D7/360
D. 261,349 10/1981 Ryser D7/393

Primary Examiner—Winifred E. Herrmann
Attorney, Agent, or Firm—Fleit, Jacobson, Cohn & Price

[57] CLAIM

The ornamental design for a handle for a pot, as shown and described.

DESCRIPTION

FIG. 1 is a bottom plan view of a handle for a pot showing my new design;
FIG. 2 is a front elevational view thereof;
FIG. 3 is a top plan view thereof;
FIG. 4 is a side elevational view thereof;
FIG. 5 is a rear elevational view thereof; and
FIG. 6 is a top perspective view thereof, showing the side opposite that shown in FIG. 4.

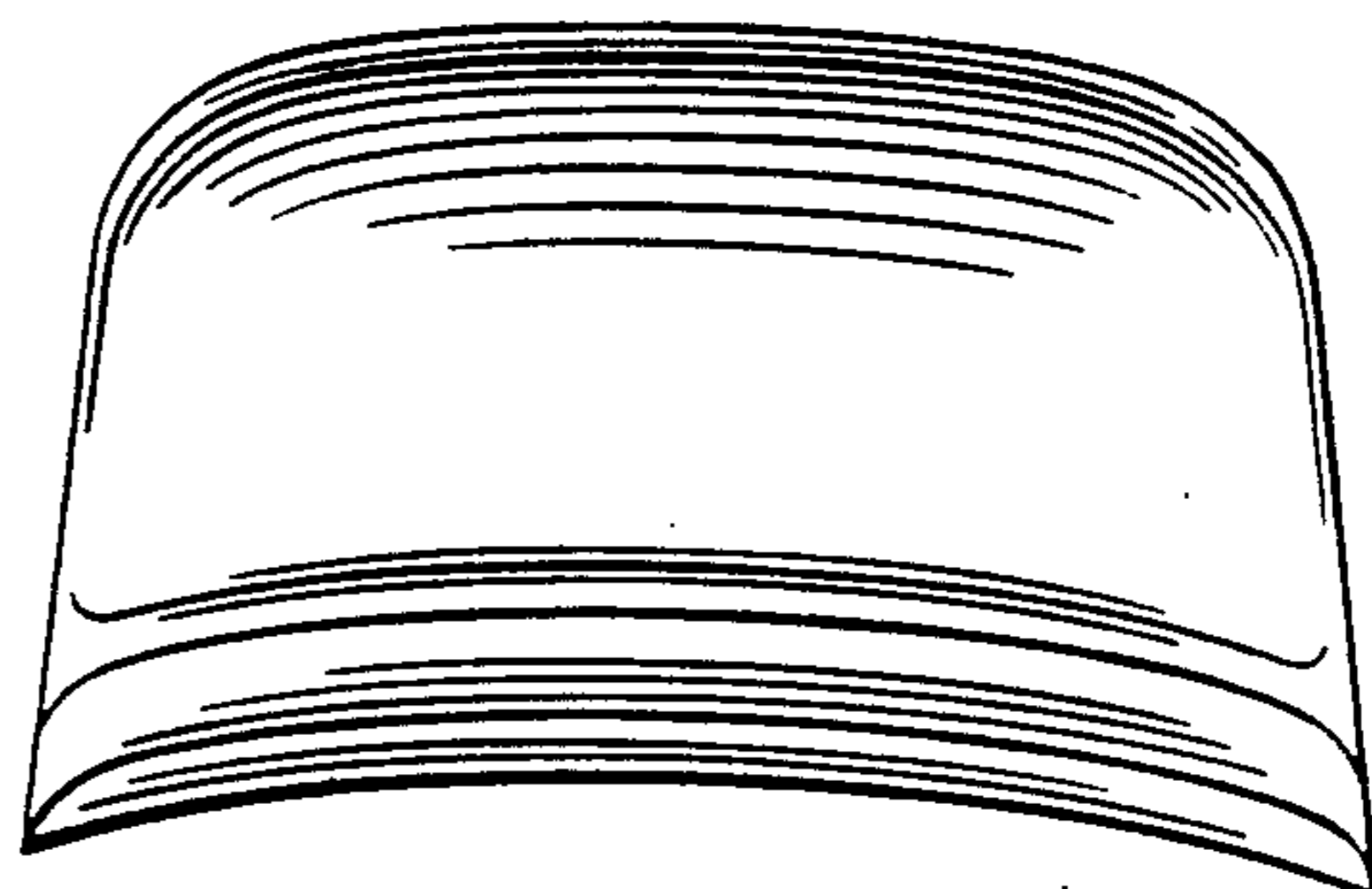
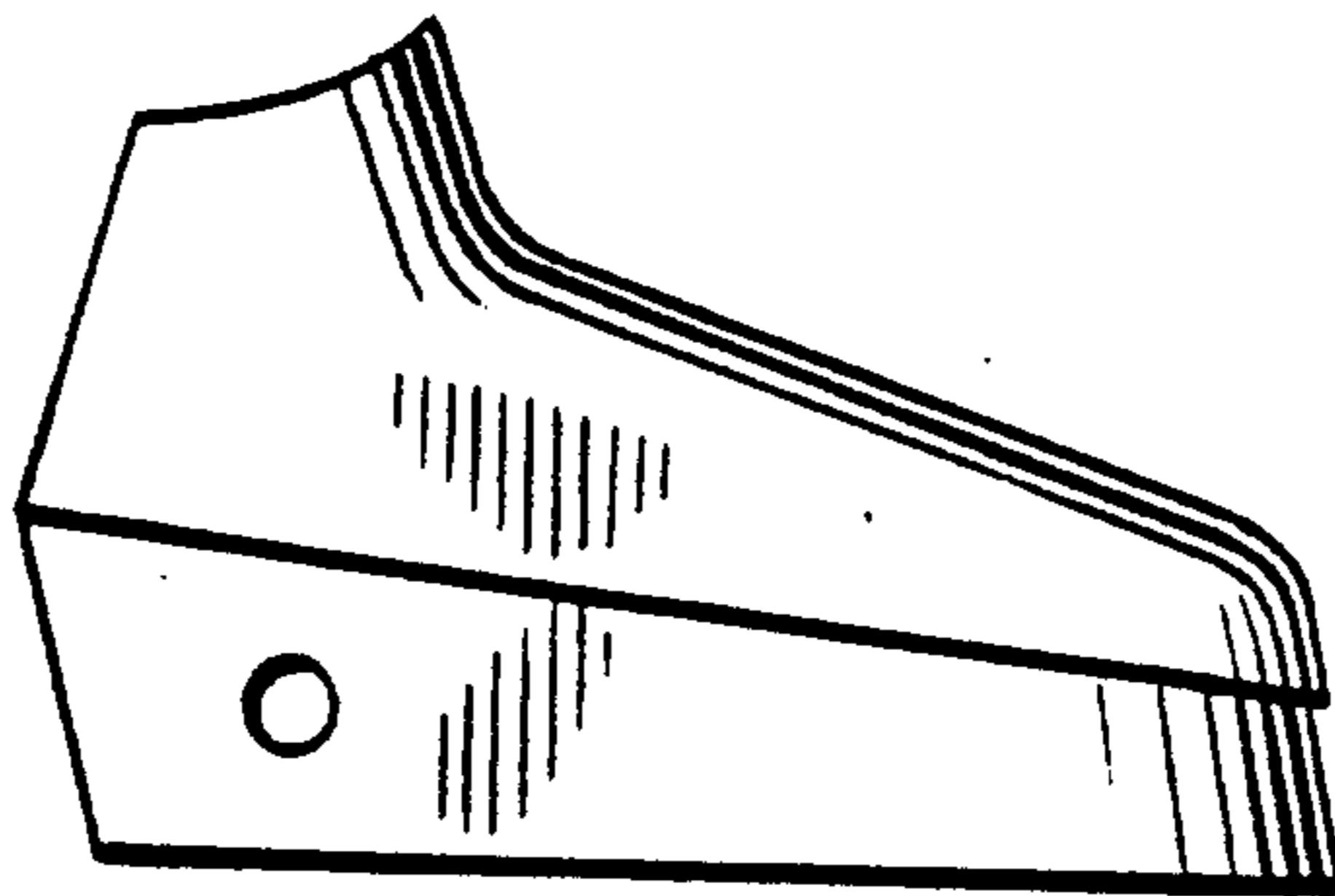
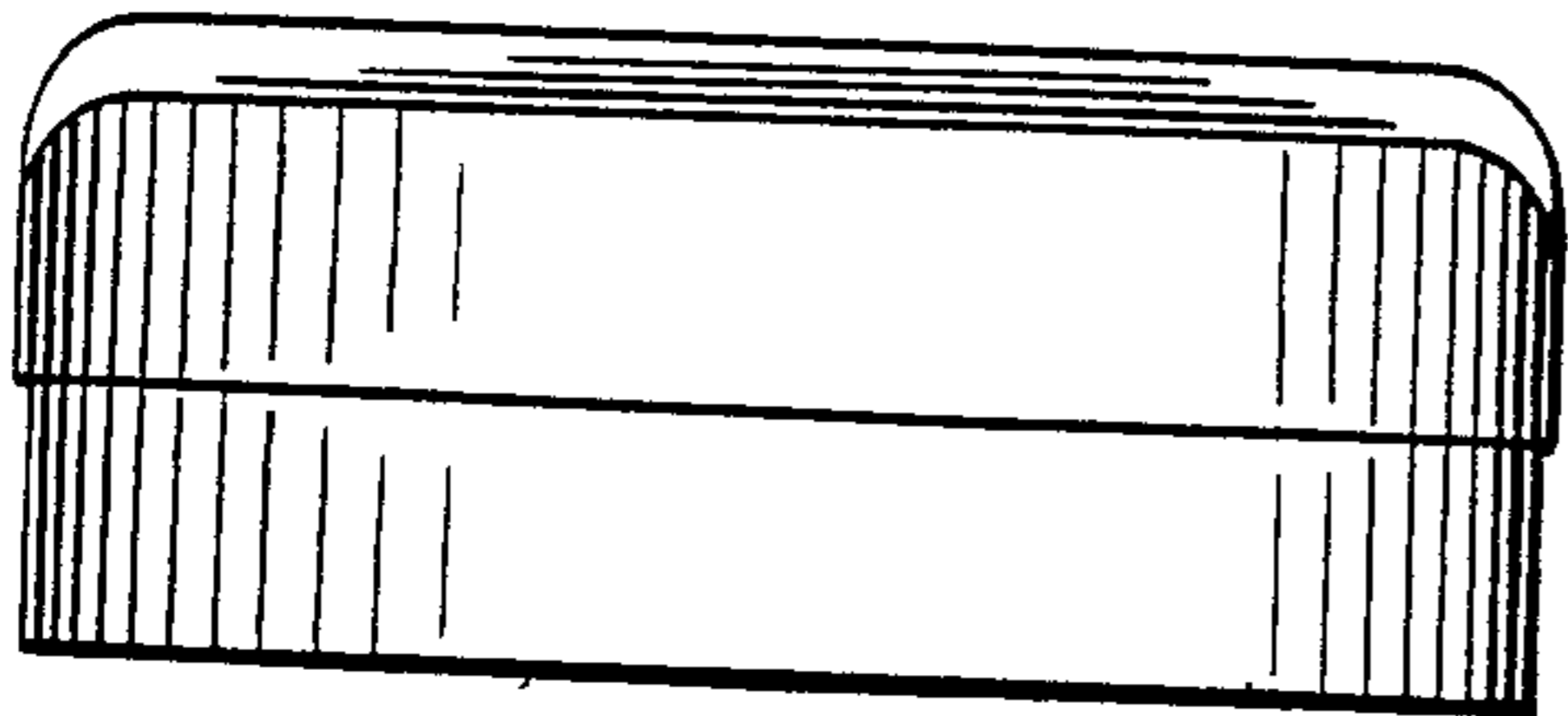

FIG. 1

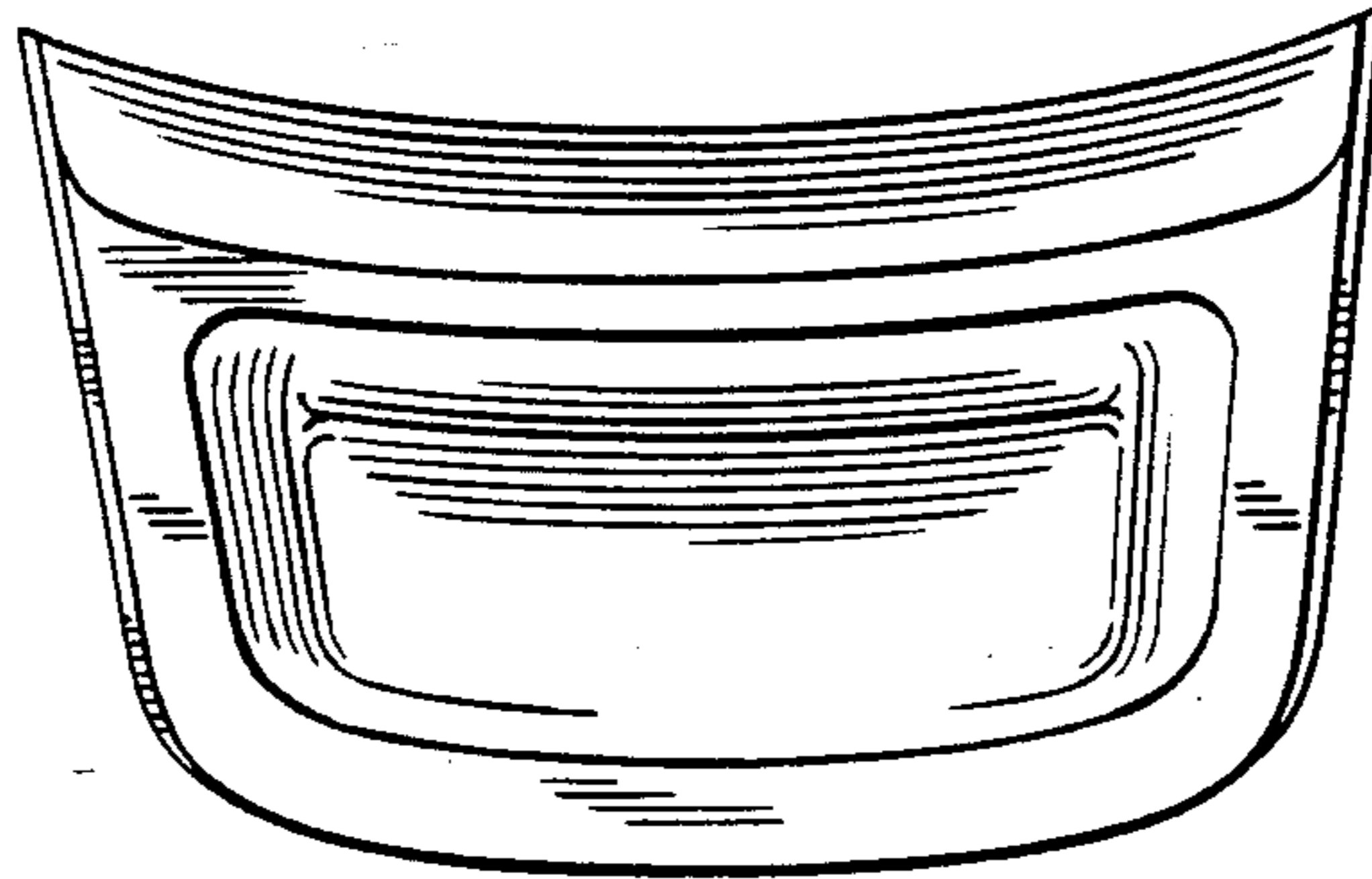

FIG. 2

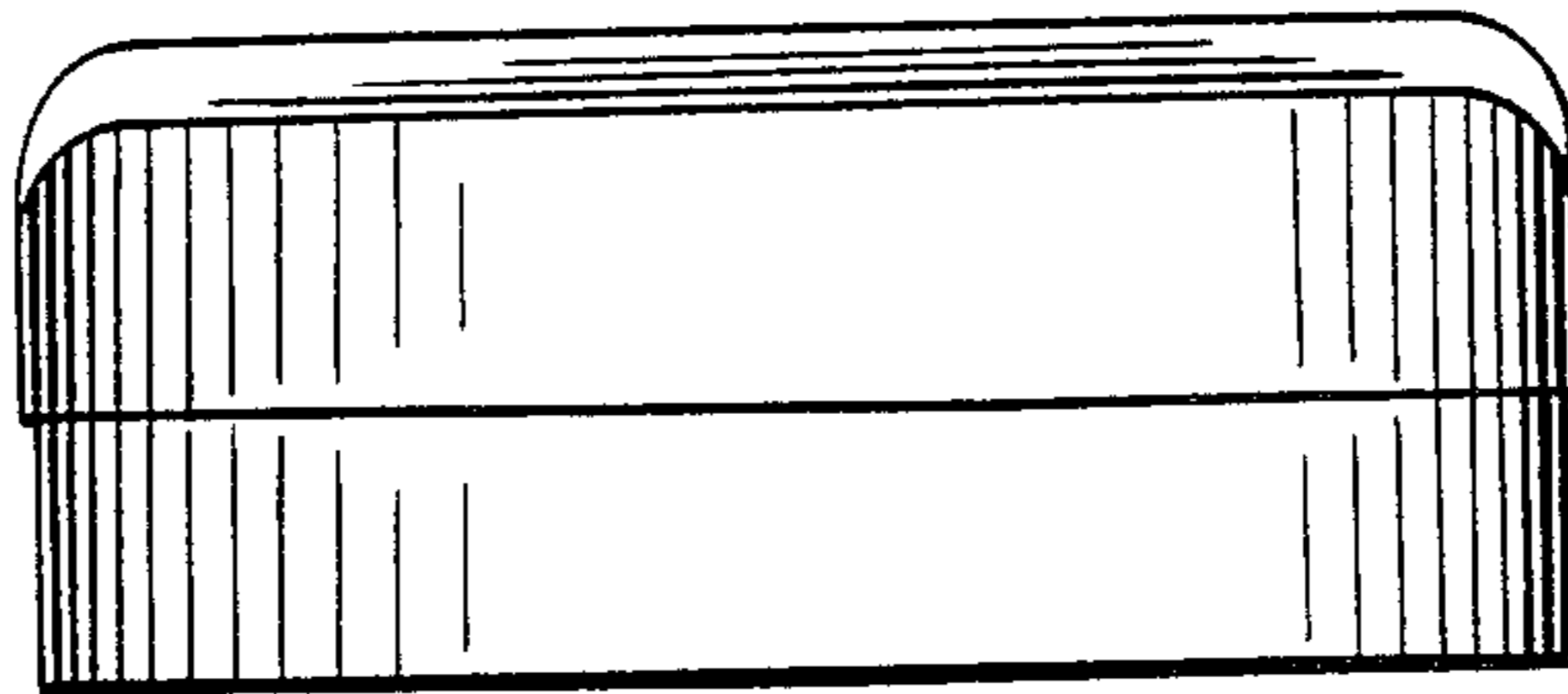

FIG. 3

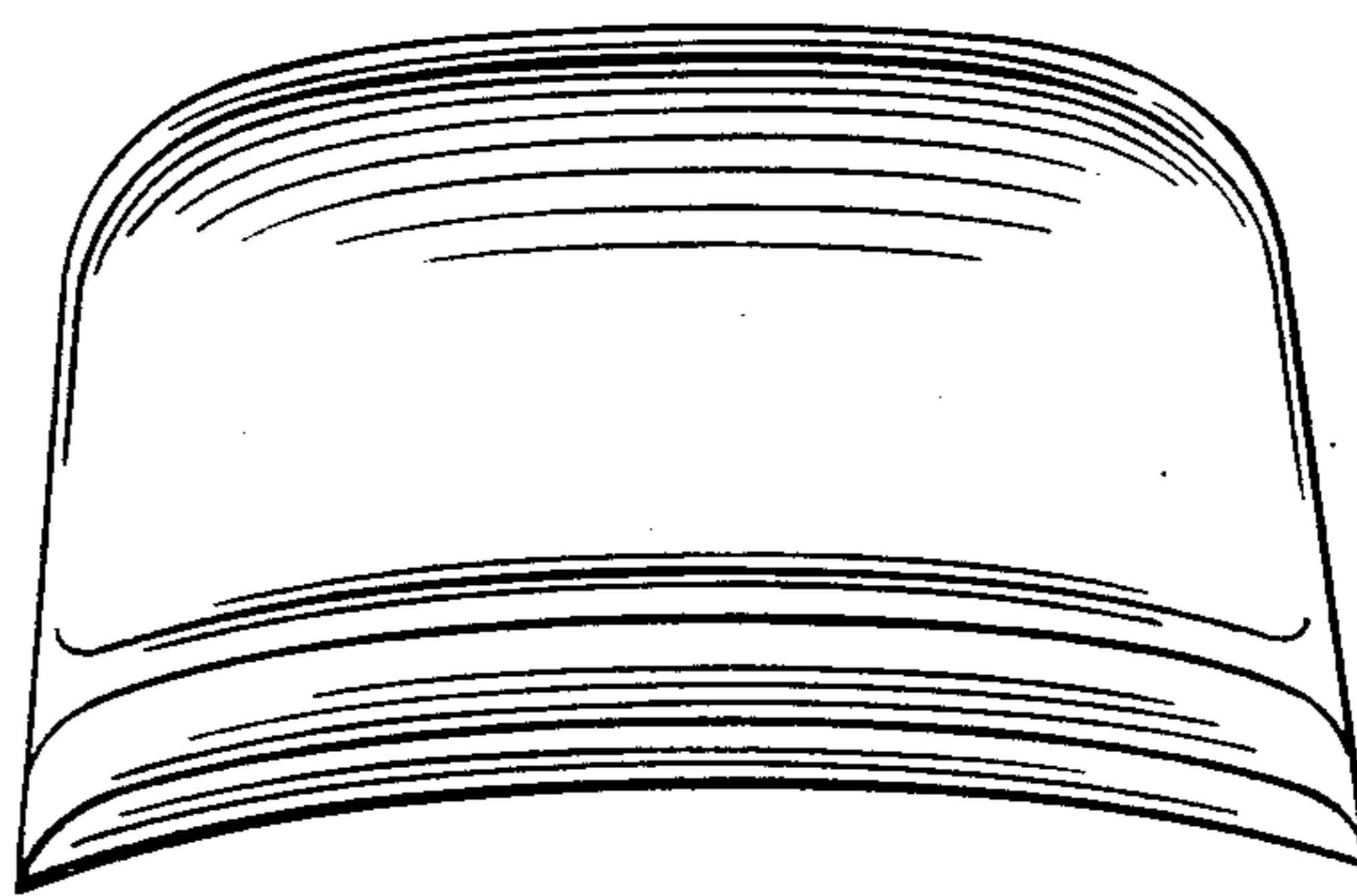

FIG. 4

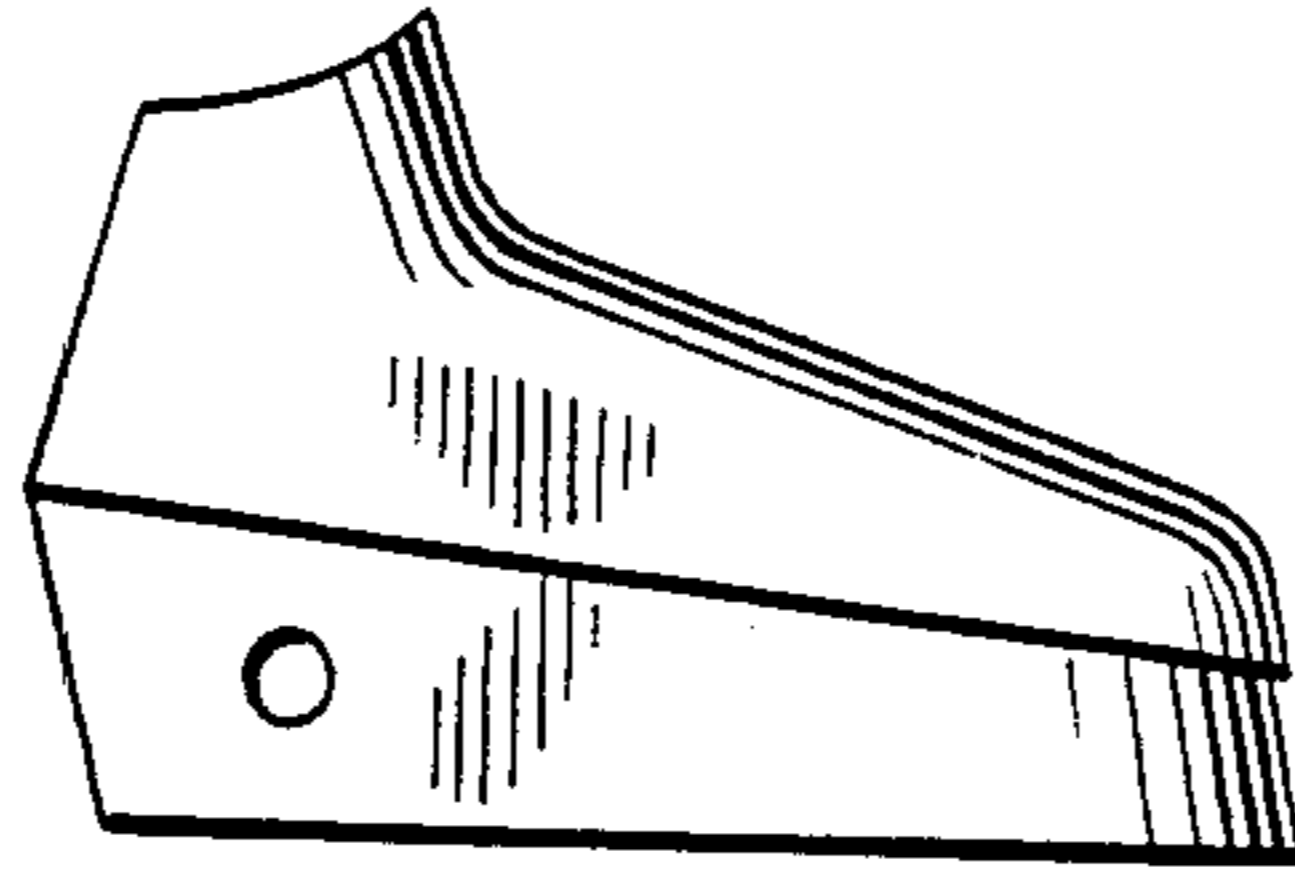

FIG. 5

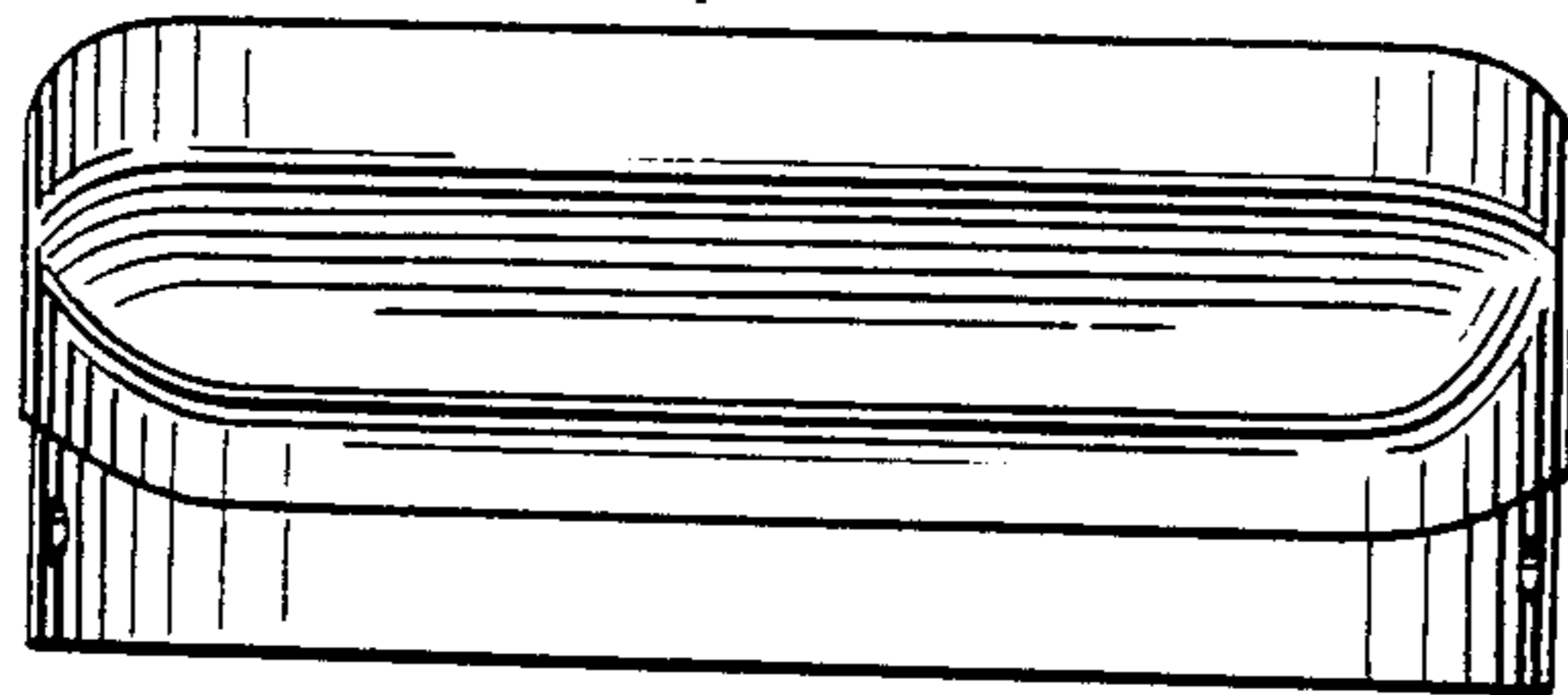

FIG. 6

