

# United States Patent [19]

Kando et al.

[11] Patent Number: **Des. 293,574**

[45] Date of Patent: **\*\* Jan. 5, 1988**

[54] **FACSIMILE**

[75] Inventors: **Masahiro Kando, Tokyo; Takashi Yomo, Yokohama; Noriyuki Suzuki, Tokyo, all of Japan**

[73] Assignee: **Canon Kabushiki Kaisha, Tokyo, Japan**

[\*\*] Term: **14 Years**

[21] Appl. No.: **720,673**

[22] Filed: **Apr. 8, 1985**

[30] **Foreign Application Priority Data**

Oct. 11, 1984 [JP] Japan ..... 59-42129

[52] U.S. Cl. .... **D14/94; D16/31**

[58] Field of Search ..... **D14/94, 99; D16/27, D16/30, 31, 32; 358/256, 285, 286**

[56] **References Cited**

**U.S. PATENT DOCUMENTS**

D. 263,831 4/1982 Barbera et al. .... D14/94

D. 264,846 6/1982 Taguchi ..... D14/94

D. 272,625 2/1984 Suzuki et al. .... D14/94  
287,364 12/1986 Kando ..... D14/94

**OTHER PUBLICATIONS**

Sanyo brochure, Sanfax 355/351.

*Primary Examiner*—Bernard Ansher

*Assistant Examiner*—Theodore M. Shooman

*Attorney, Agent, or Firm*—Fitzpatrick, Cella, Harper & Scinto

[57] **CLAIM**

The ornamental design for a facsimile, as shown and described.

**DESCRIPTION**

FIG. 1 is a front elevational view of a facsimile showing my new design;

FIG. 2 is a rear elevational view thereof;

FIG. 3 is a top plan view thereof;

FIG. 4 is a bottom plan view thereof;

FIG. 5 is a left side elevational view thereof;

FIG. 6 is a right side elevational view thereof; and

FIG. 7 is a top, front and left side perspective view thereof.

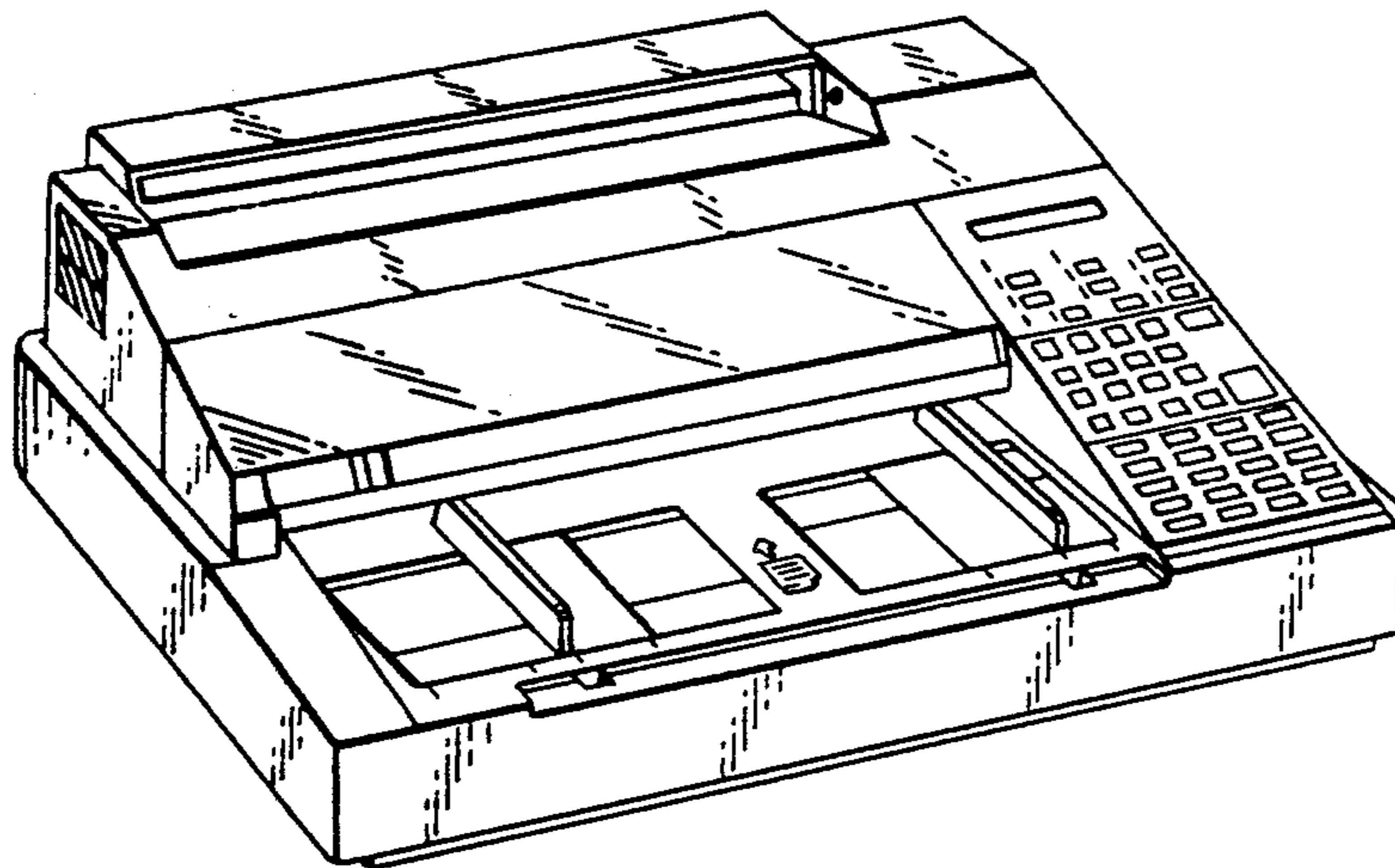

FIG. 1

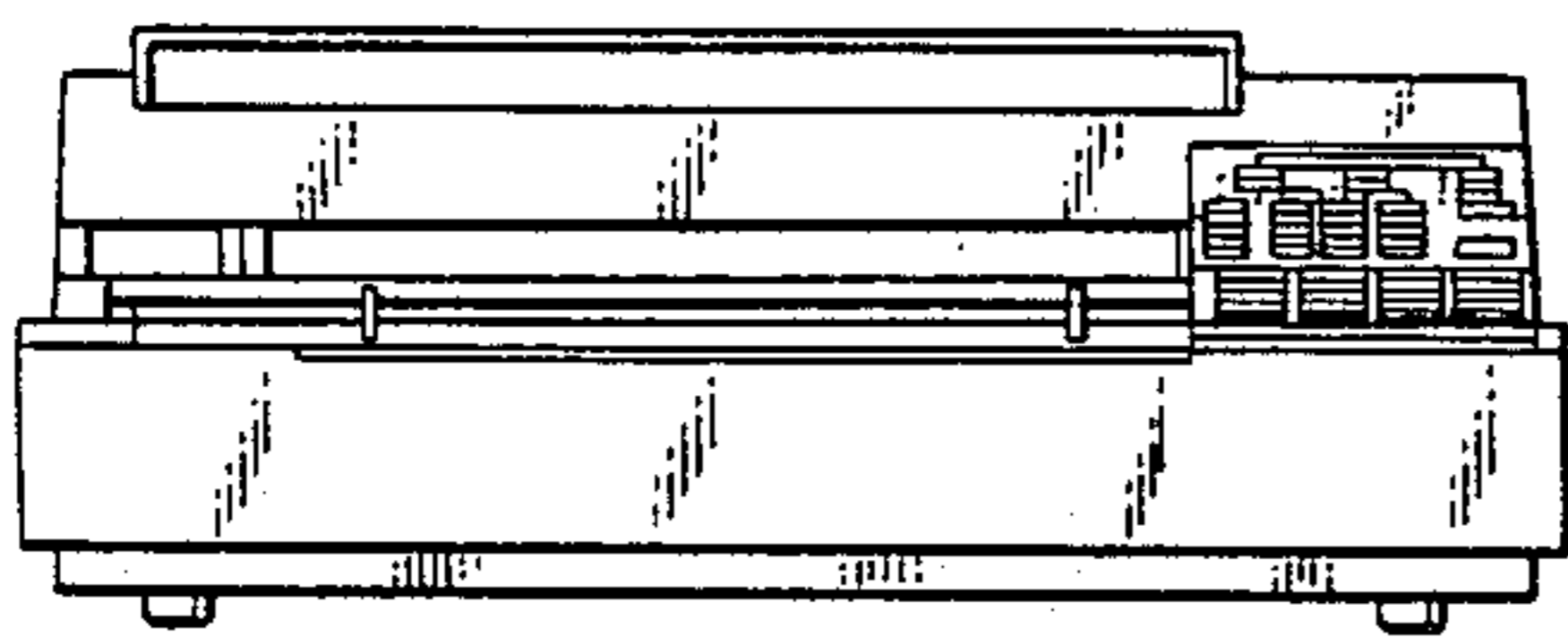

FIG. 2

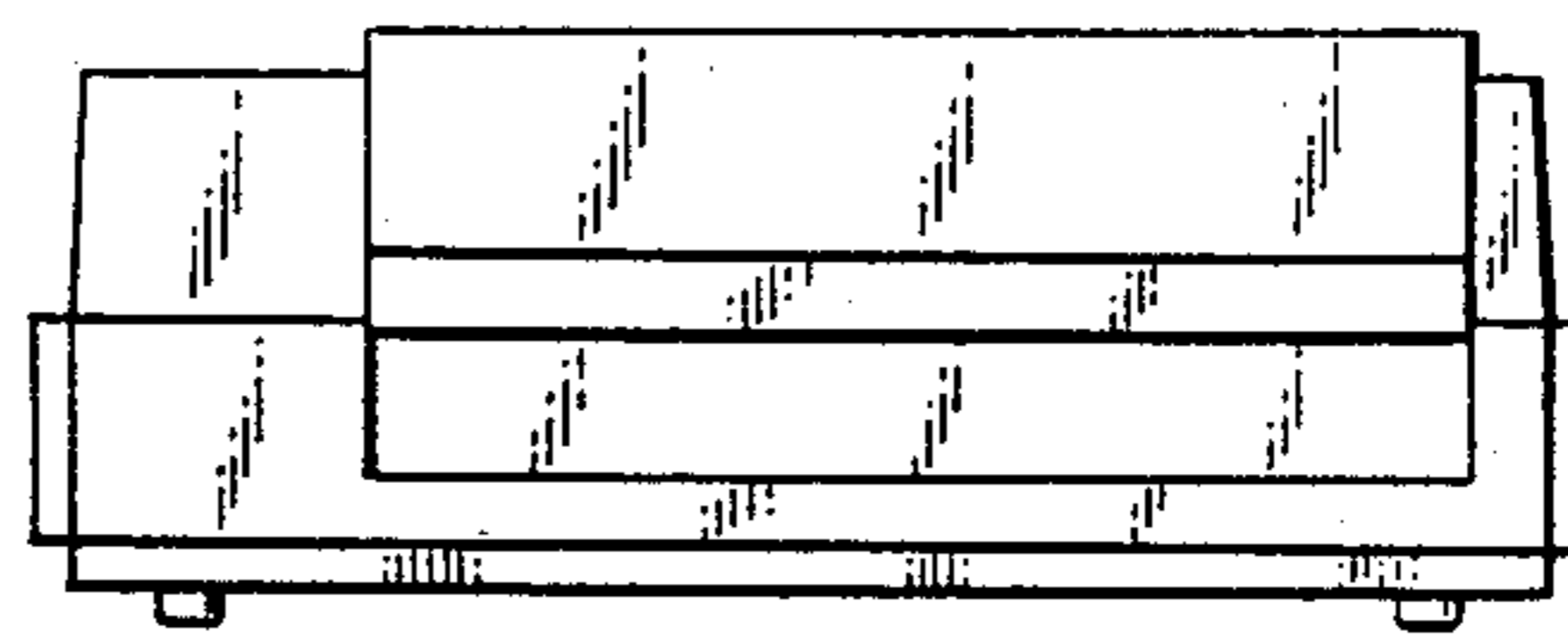

FIG. 3

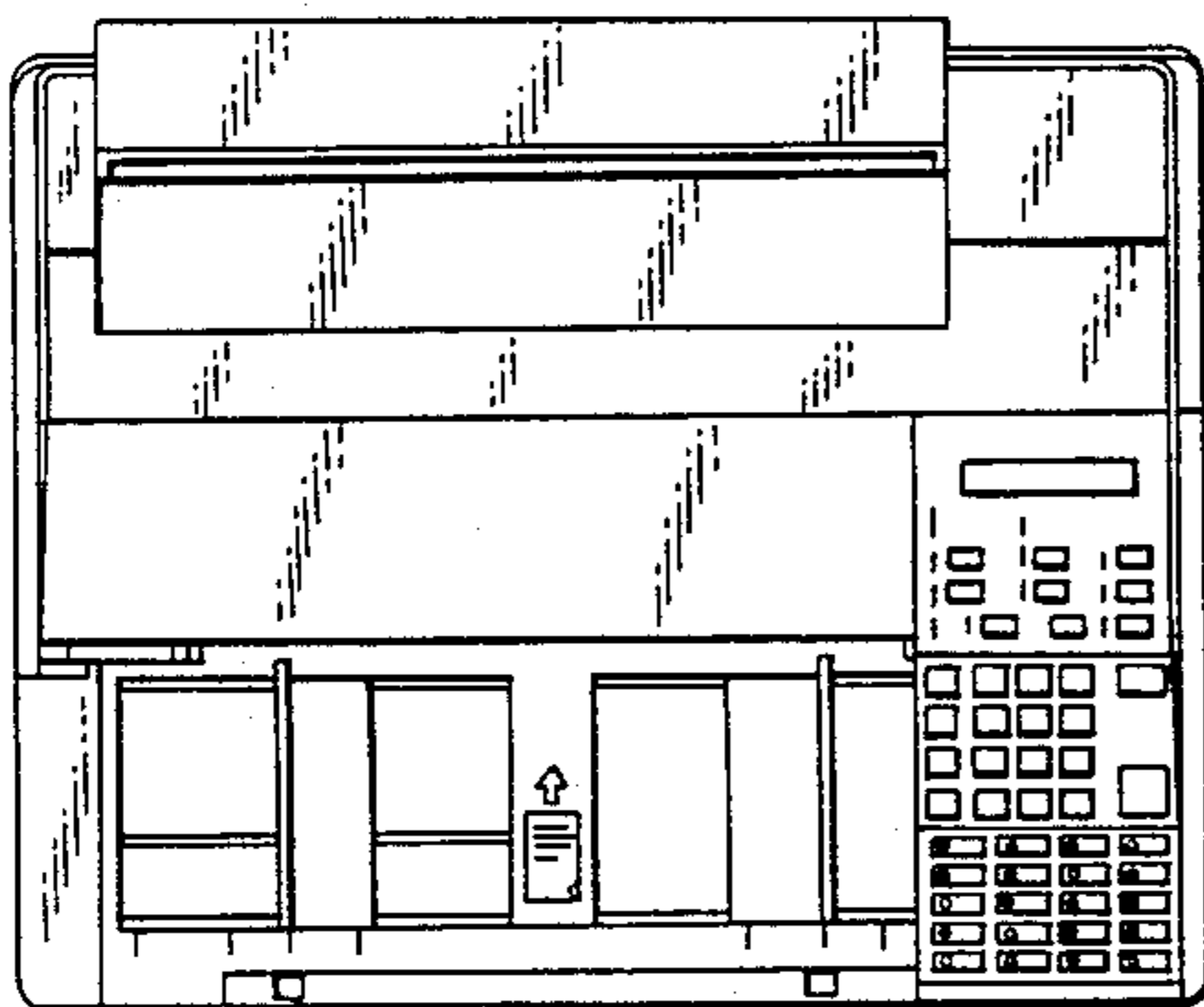

FIG. 4

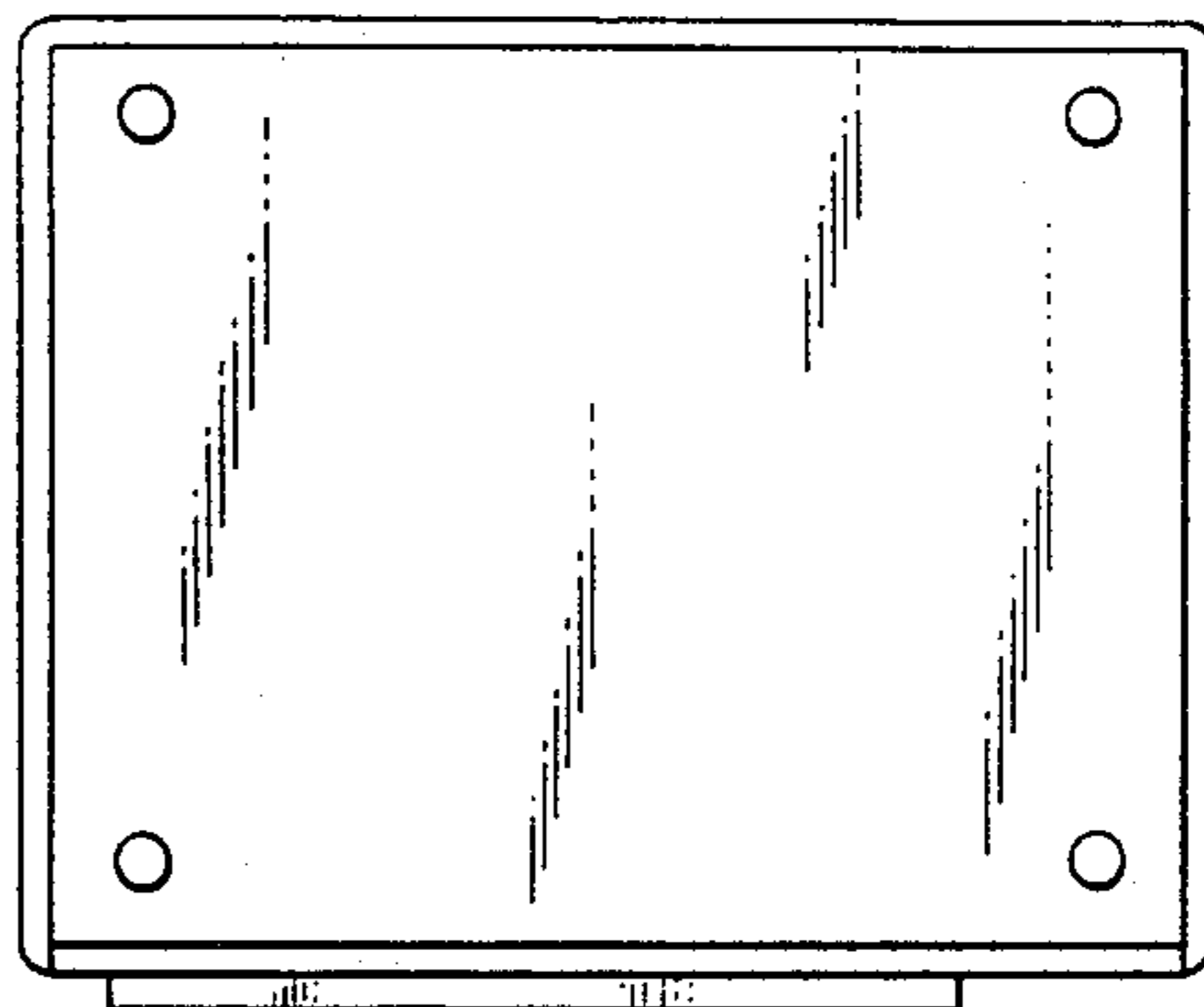

FIG. 5

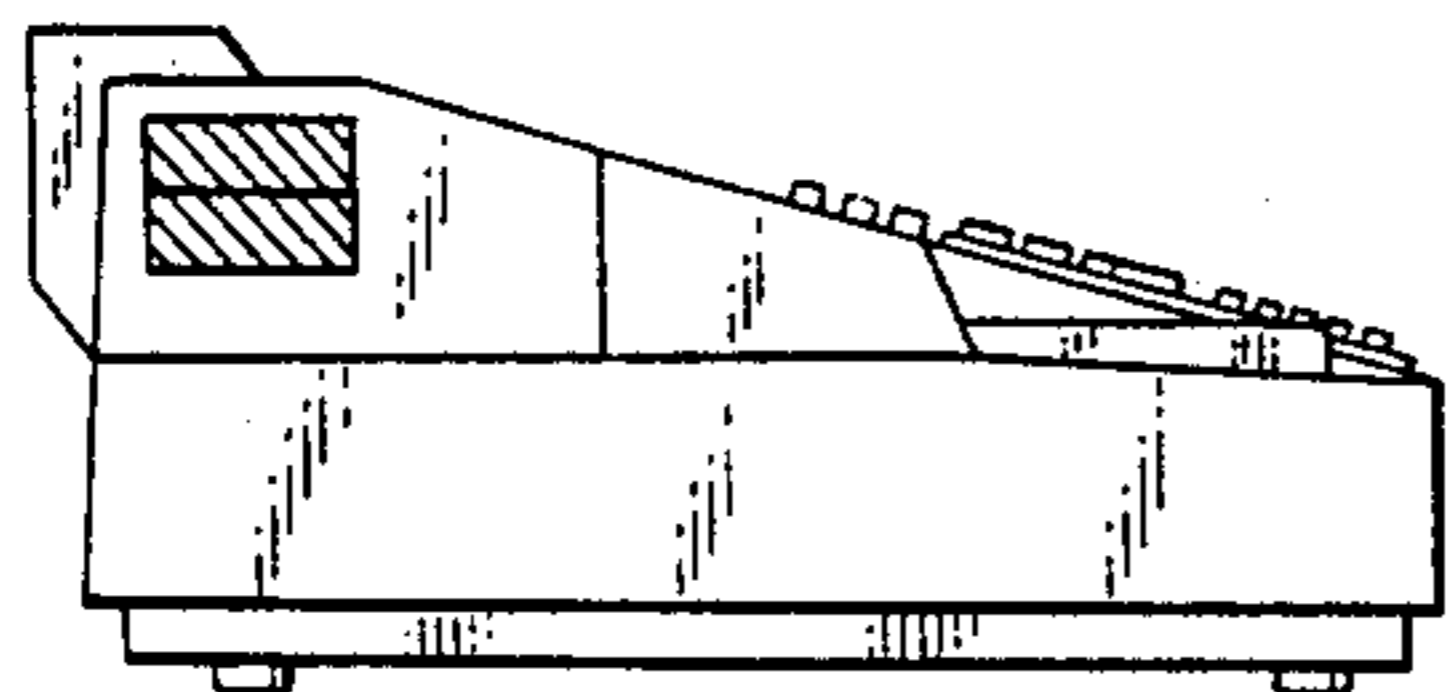

FIG. 6

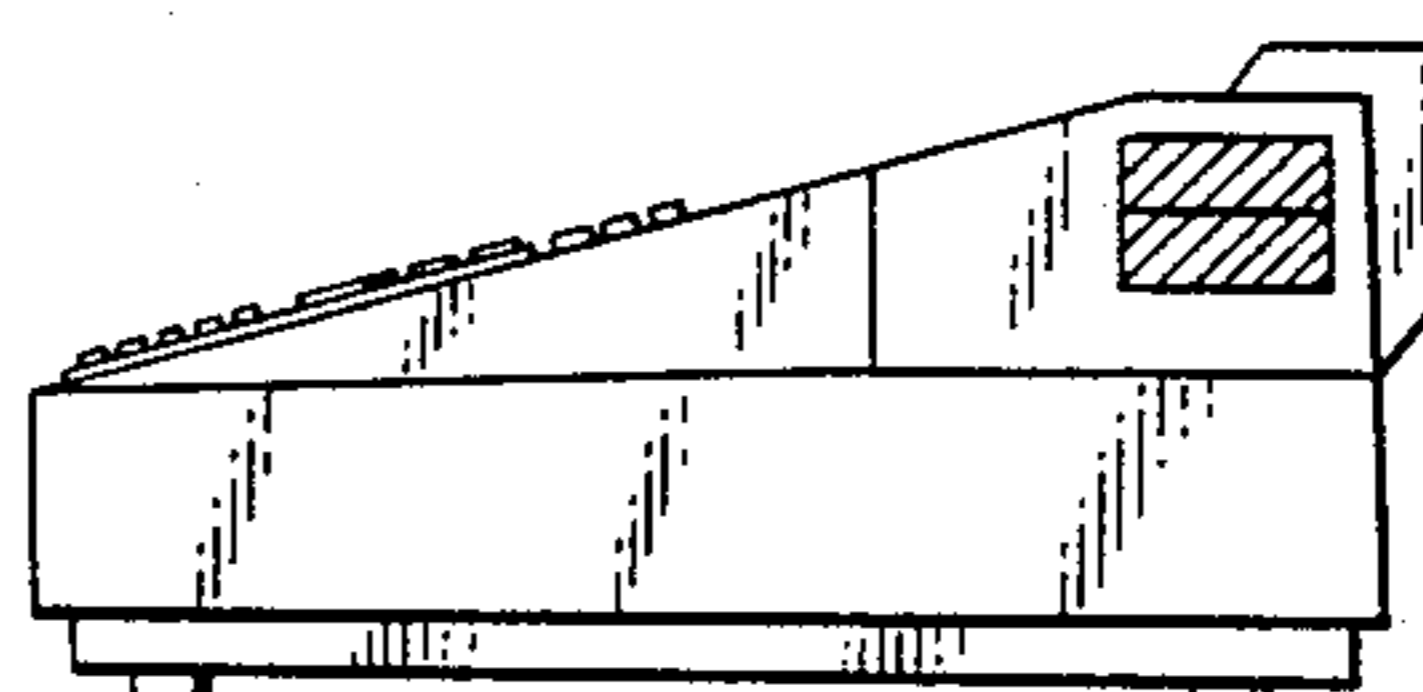

FIG. 7

