

[54] COMBINATION FLOSS HOLDER AND KEY CHAIN FOB OR SIMILAR ARTICLE

[76] Inventor: Robert D. Fronske, 1433 E. Wesleyan Dr., Tempe, Ariz. 85282

[**] Term: 14 Years

[21] Appl. No.: 766,353

[22] Filed: Aug. 16, 1985

[52] U.S. Cl. D28/64

[58] Field of Search D28/64; D11/79; 132/90-93

[56] References Cited

U.S. PATENT DOCUMENTS

D. 255,388	6/1980	Olson	132/92 R
D. 261,566	10/1981	Olson	D28/64
D. 266,194	9/1982	Graves	D28/64
D. 266,279	9/1982	Strother	D28/64
2,931,196	4/1960	Liftman	D11/79

4,019,522 4/1977 Elbreder 132/90

Primary Examiner—James M. Gandy
Assistant Examiner—Kay H. Chin
Attorney, Agent, or Firm—Don J. Flickinger; Jordan M. Meschkow

[57] CLAIM

The ornamental design for a combination floss holder and key chain fob or similar article, as shown.

DESCRIPTION

FIG. 1 is a perspective view of a combination floss holder and key chain fob or similar article showing my new design;

FIG. 2 is a top plan view thereof;

FIG. 3 is a bottom plan view thereof;

FIG. 4 is a front elevational view thereof;

FIG. 5 is a rear elevational view thereof;

FIG. 6 is a right side elevational view thereof; and,

FIG. 7 is a left side elevational view thereof.

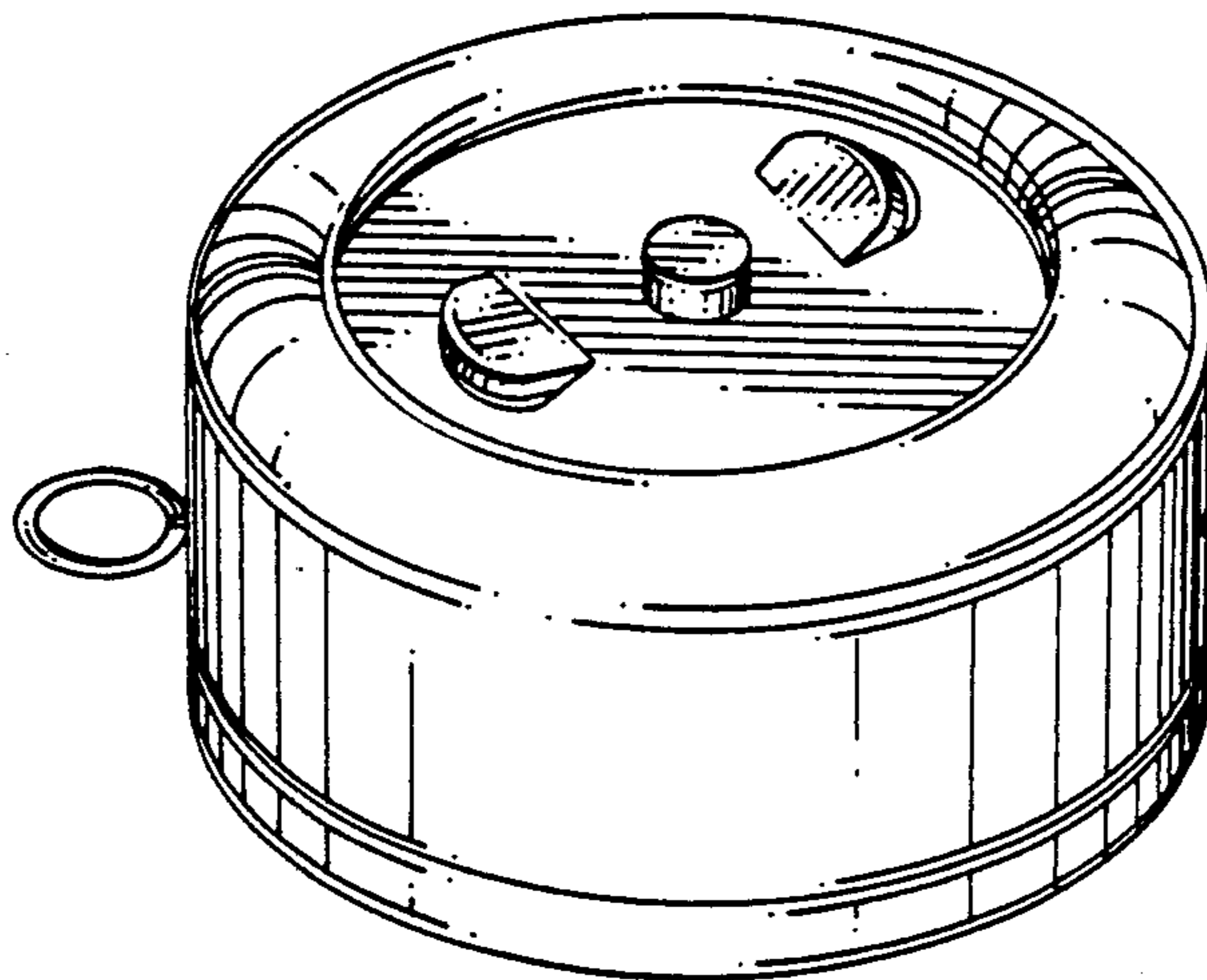

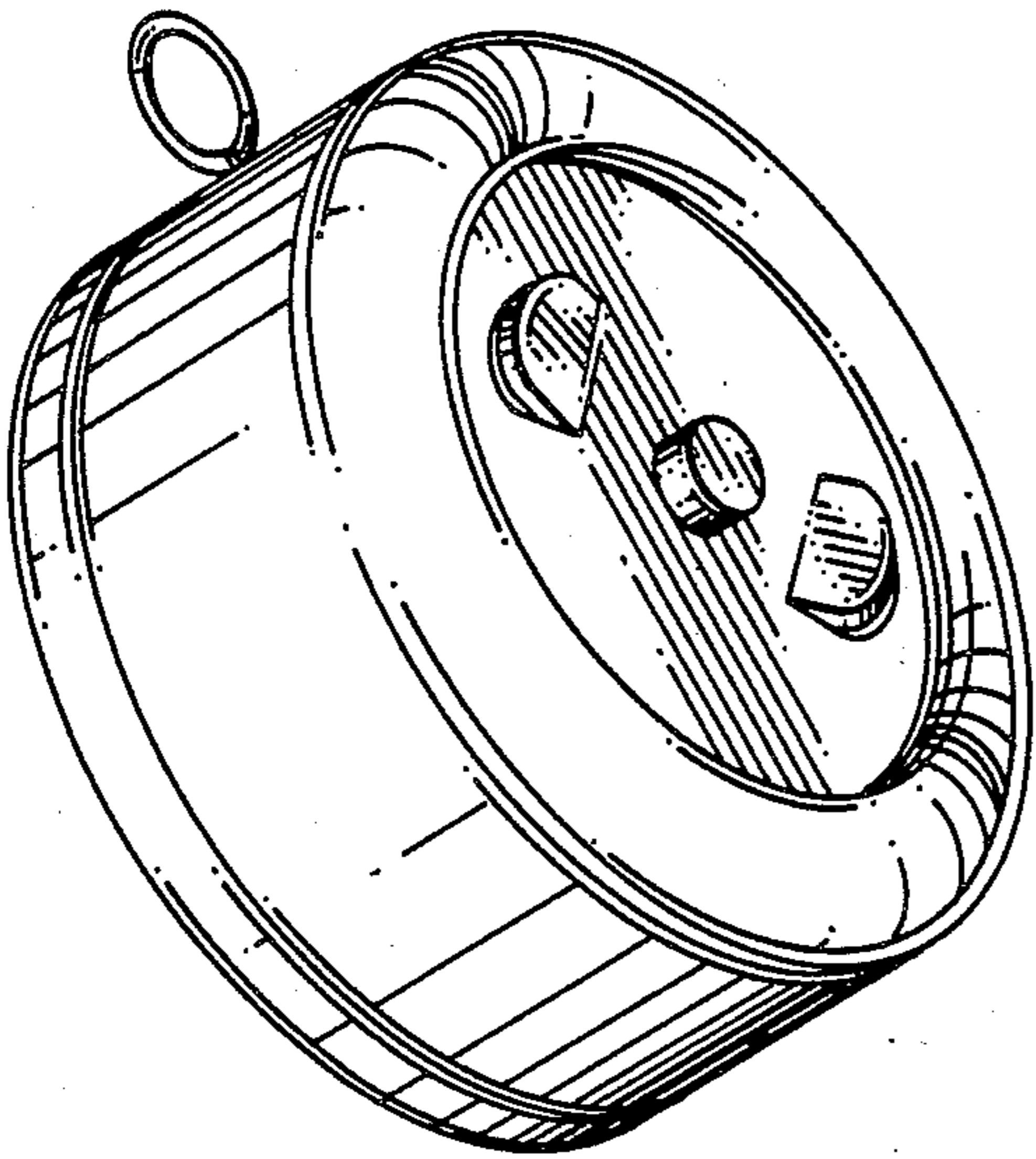

FIG. 1

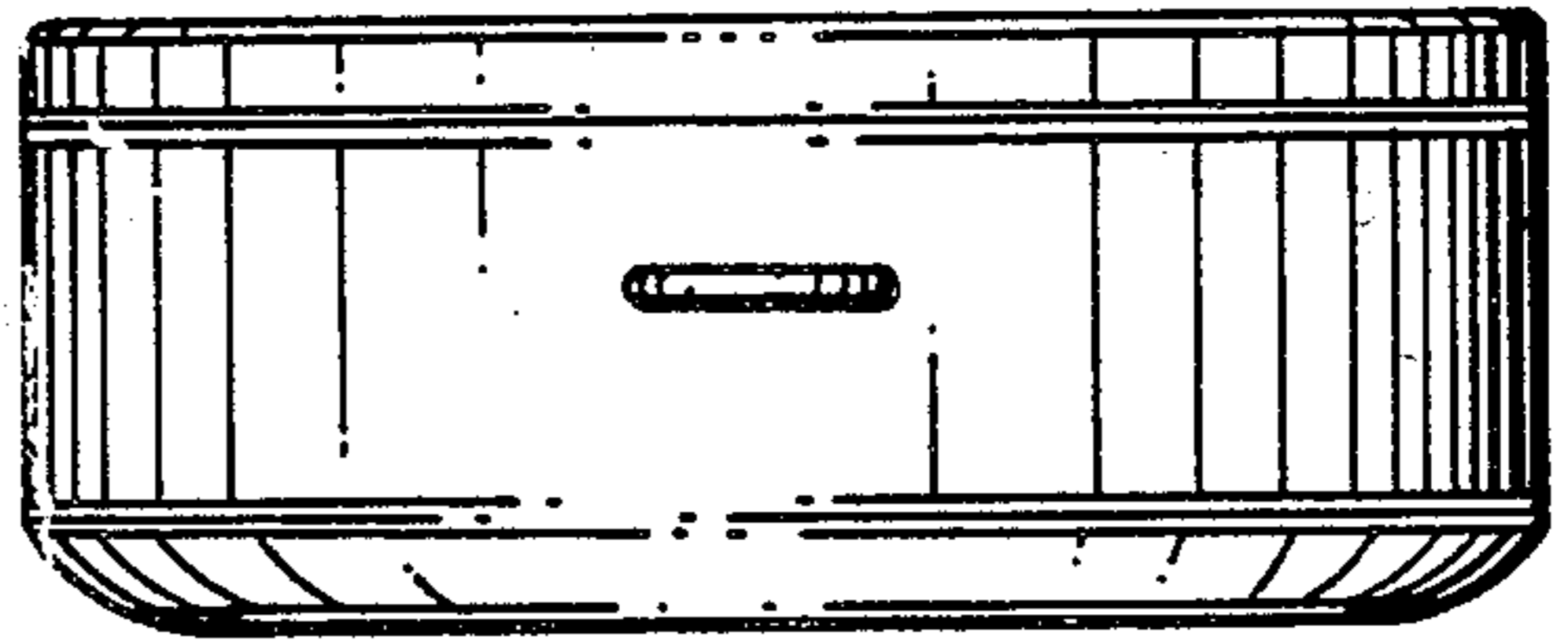

FIG. 2

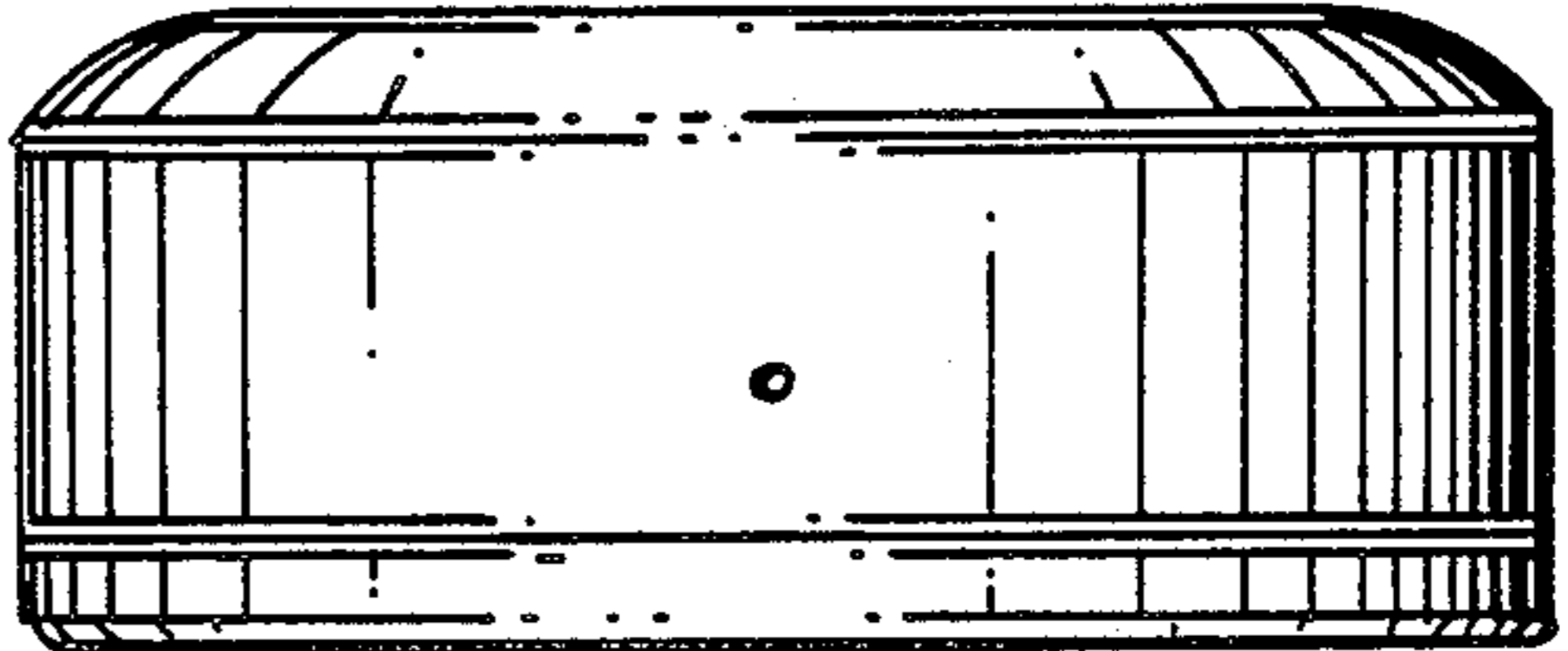

FIG. 3

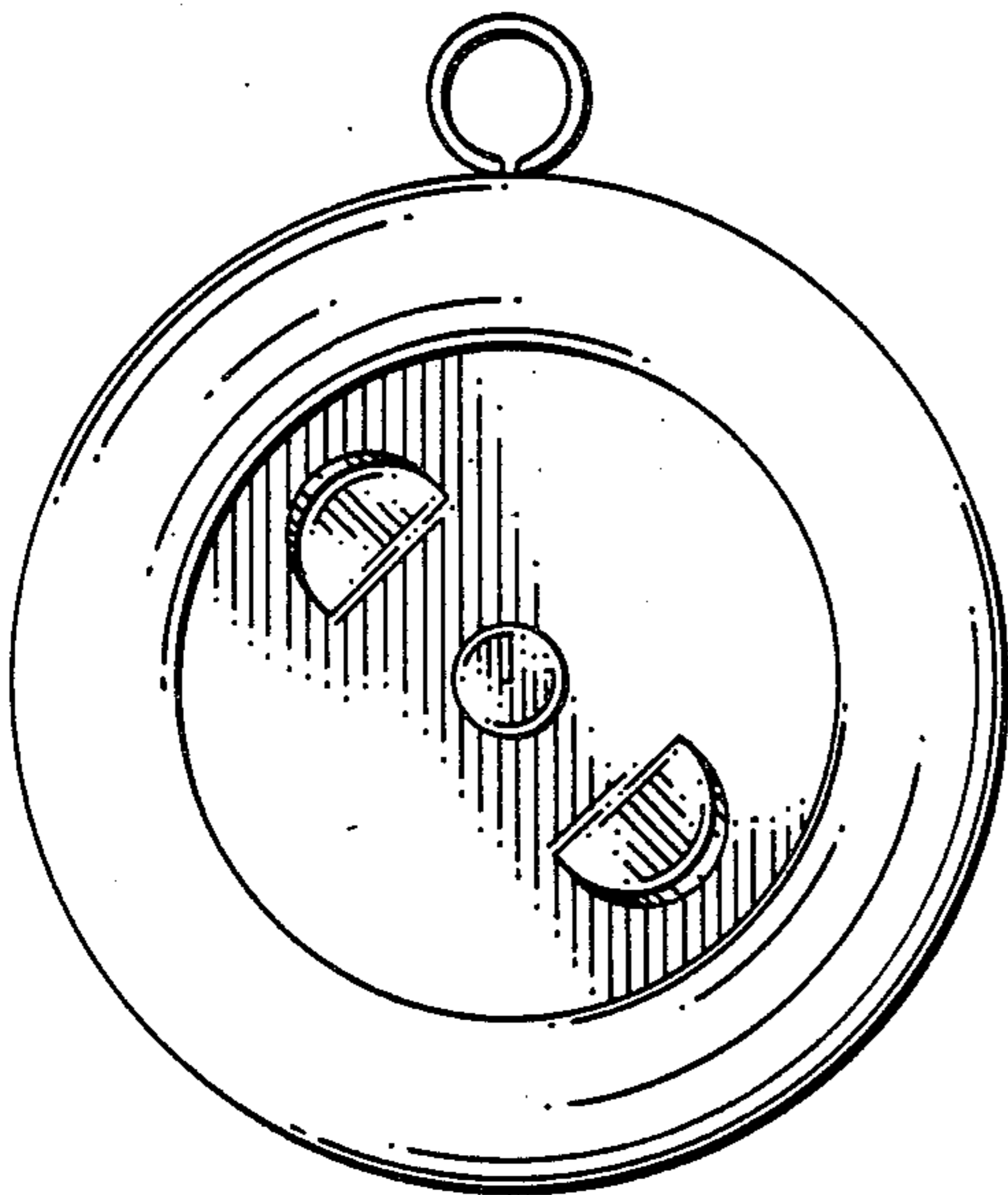

FIG. 4

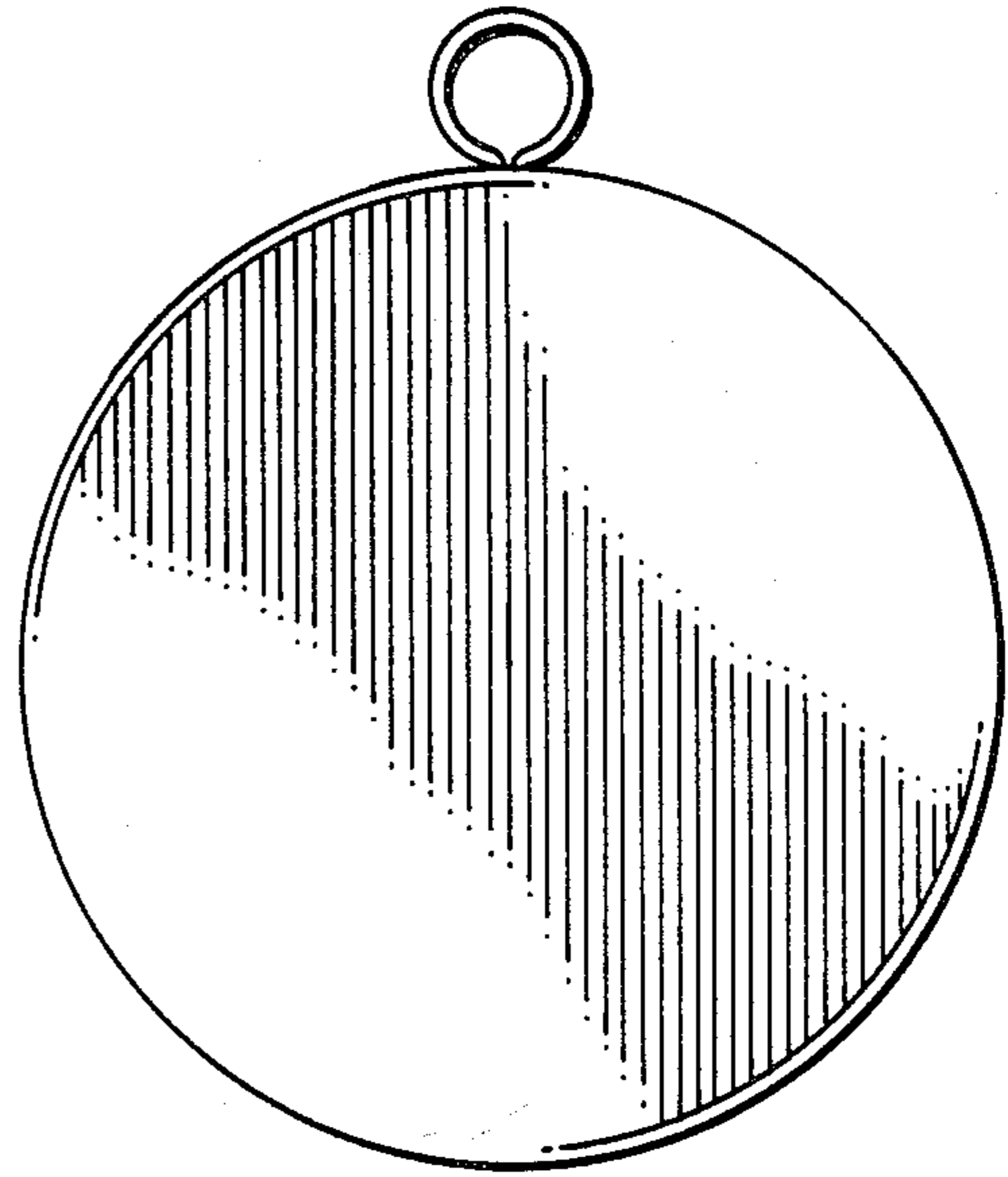

FIG. 5

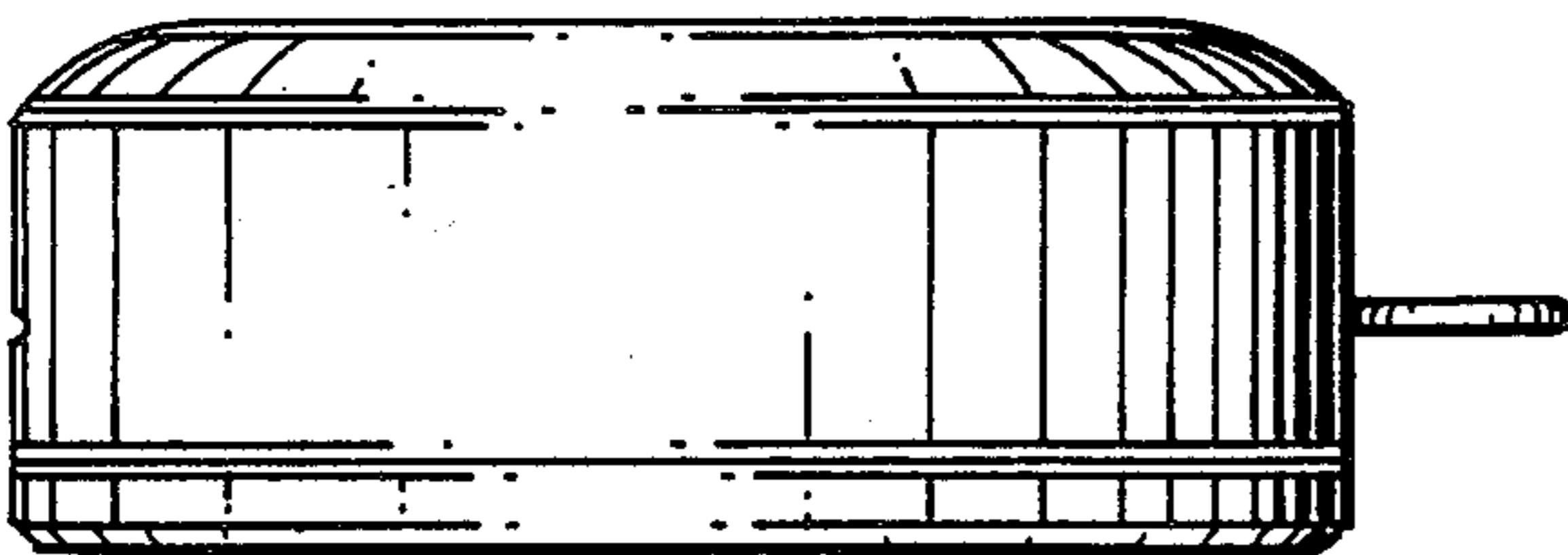

FIG. 6

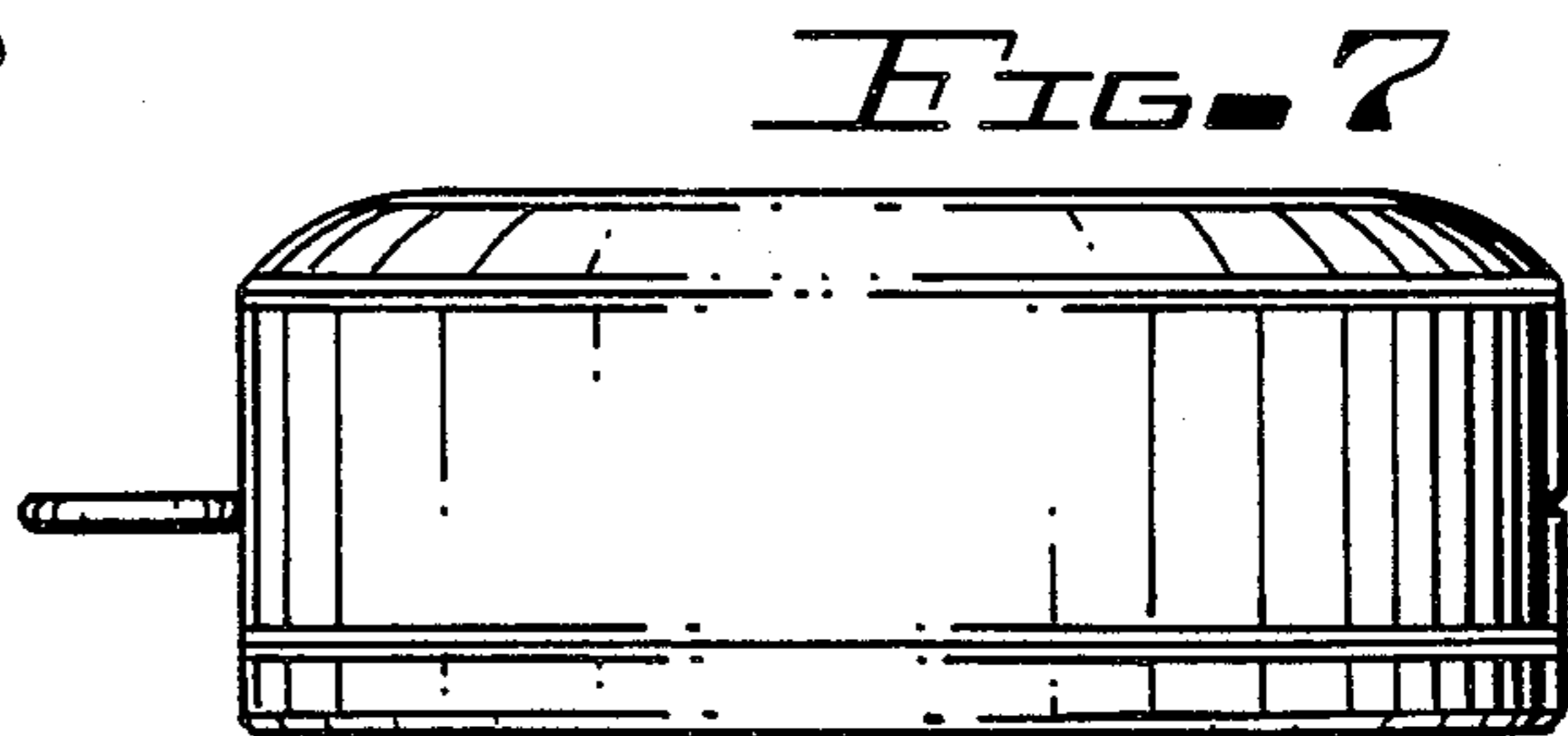

FIG. 7