

[54] SPRING LOADED CLIP FOR A HAIR ROLLER OR THE LIKE

[75] Inventor: Peter L. Franzino, Jacksonville, Fla.

[73] Assignee: Zip Clip, Inc., Jacksonville, Fla.

[**] Term: 14 Years

[21] Appl. No.: 782,034

[22] Filed: Sep. 30, 1985

[52] U.S. CL. D28/40; D28/25; D28/29

[58] Field of Search D28/35, 37, 39-43, D28/21, 25-27, 28-32; 132/46 R, 46 A, 48 R, 48 A, 50 R-52, 138, 151

[56] References Cited

U.S. PATENT DOCUMENTS

- D. 210,860 4/1968 Schellens D28/40
- D. 270,296 8/1983 Thomas D28/31
- D. 282,298 1/1986 Mazzaferro D28/31

- 1,929,849 10/1933 Noto D28/29 X
- 2,187,474 1/1940 Keele D28/35 X
- 4,414,992 11/1983 Russell 132/138 X

Primary Examiner—Louis S. Zarfes
Attorney, Agent, or Firm—Arthur G. Yeager

[57] CLAIM

The ornamental design for spring loaded clip for a hair roller or the like, substantially as shown and described.

DESCRIPTION

FIG. 1 is a side elevational view of the spring loaded clip for a hair roller or the like showing my new design; FIG. 2 is a right end elevational view thereof, the left end elevational view being identical thereto; FIG. 3 is a top plan view thereof; FIG. 4 is a right end elevational view showing the limit of opening thereof; FIG. 5 is a bottom plan view of FIG. 4; and FIG. 6 is a right end elevational view showing the limit of closure thereof.

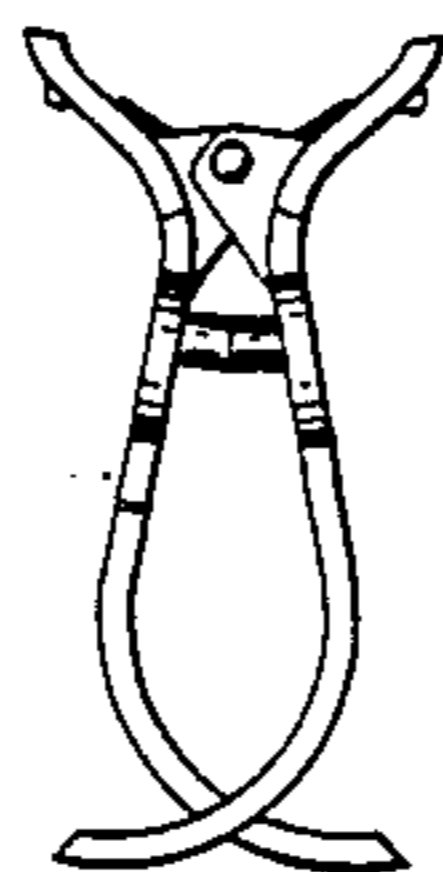
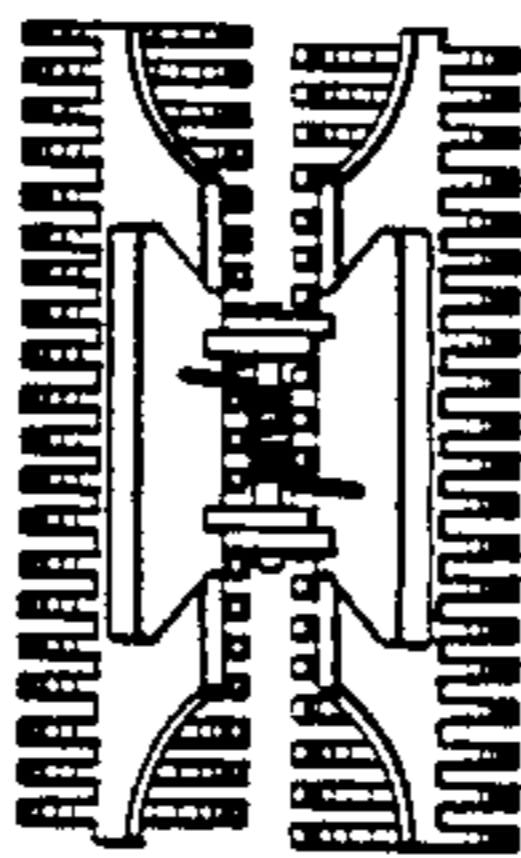
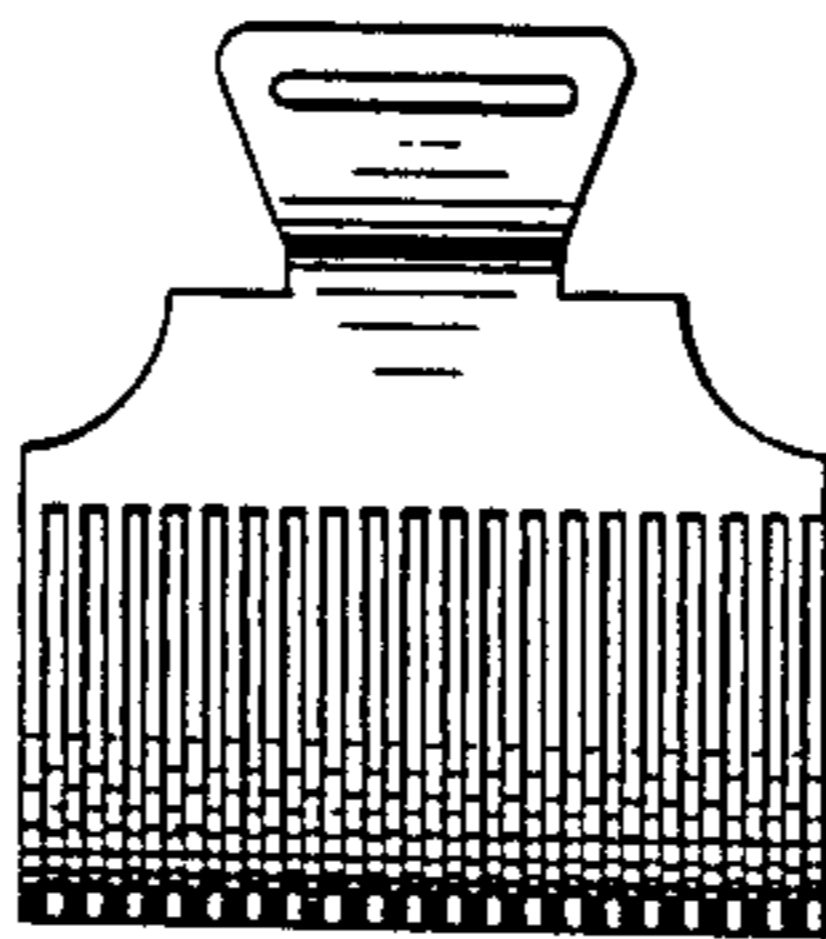

FIG. 1

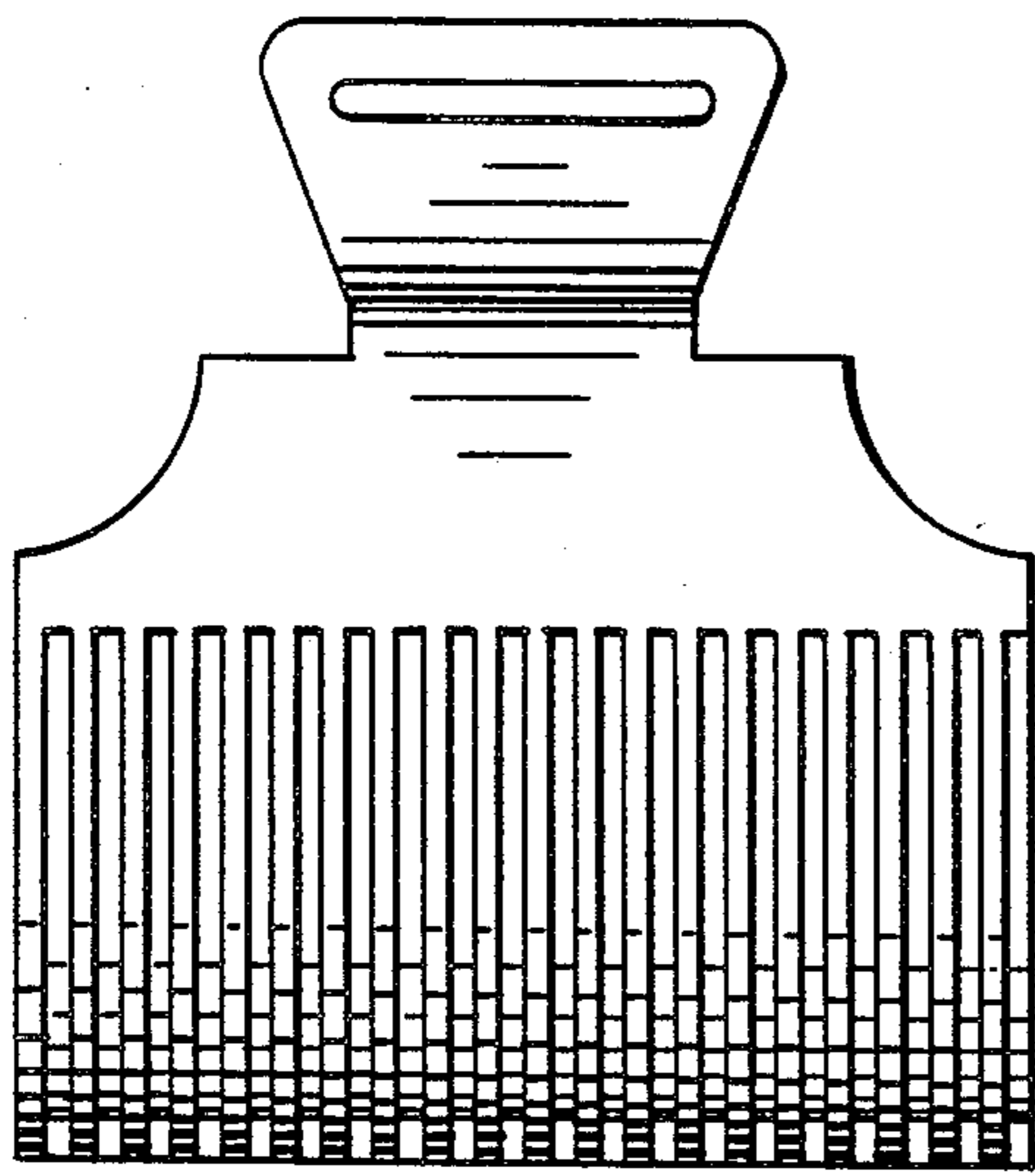

FIG. 2

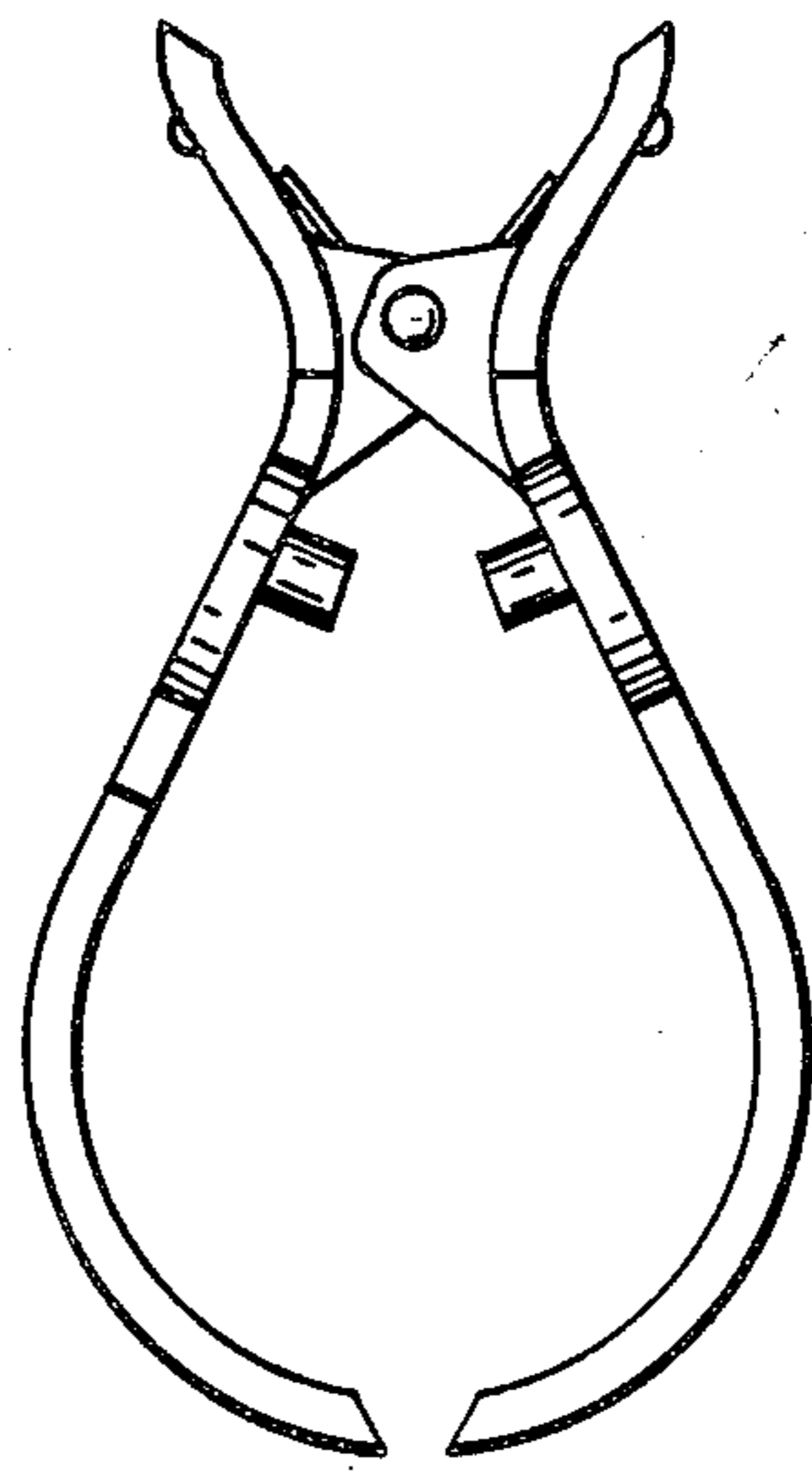

FIG. 3

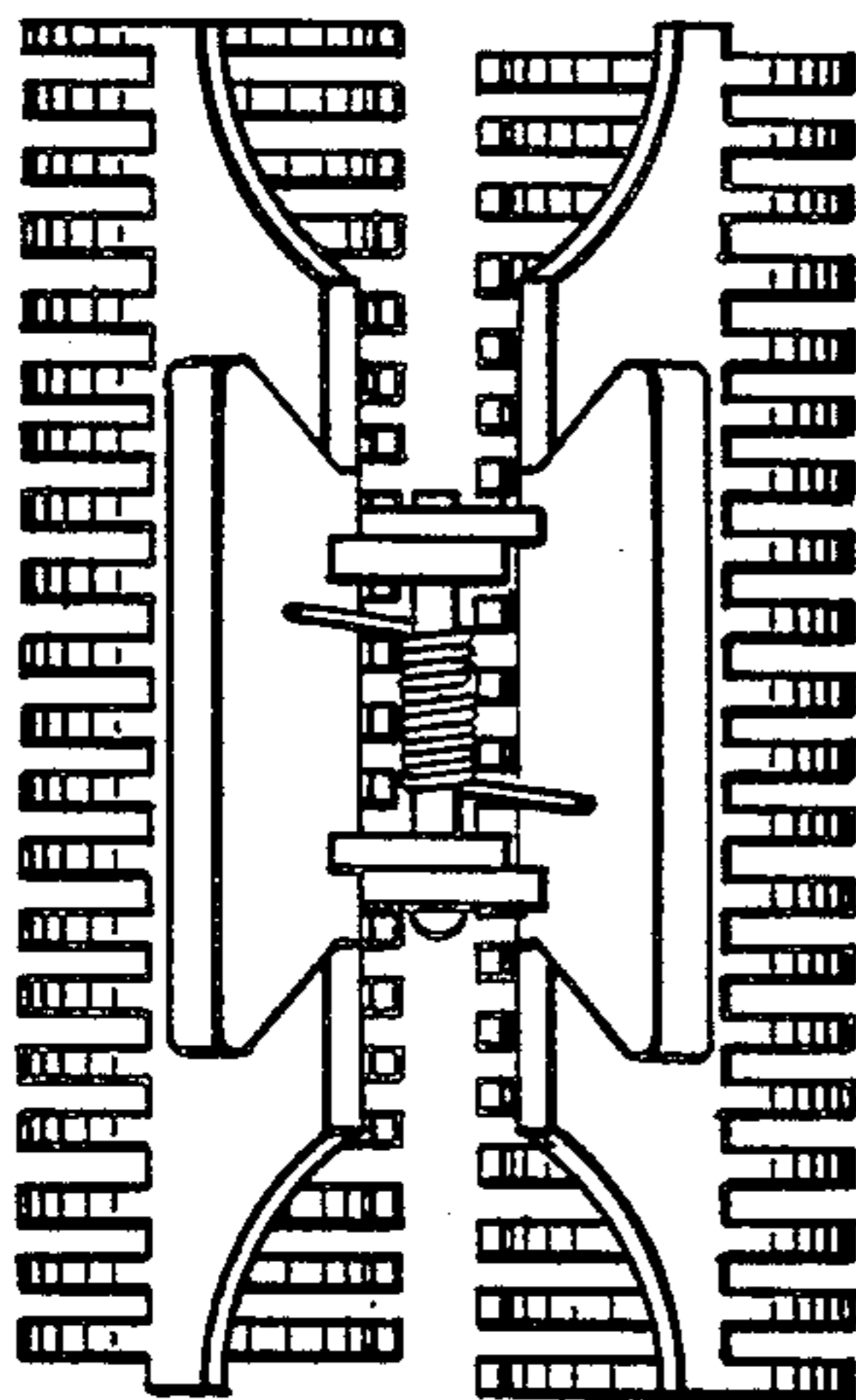

FIG. 4

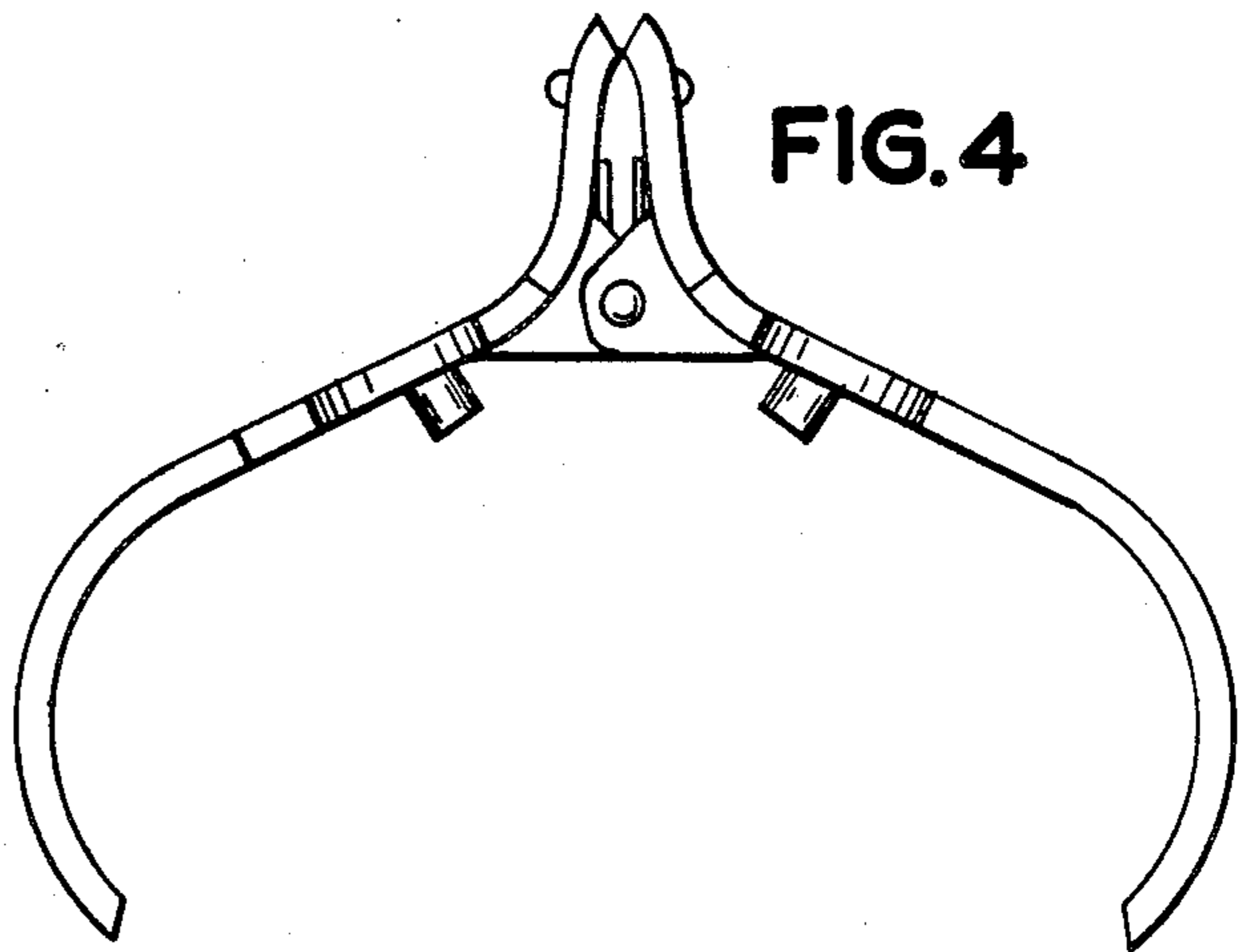

FIG. 6

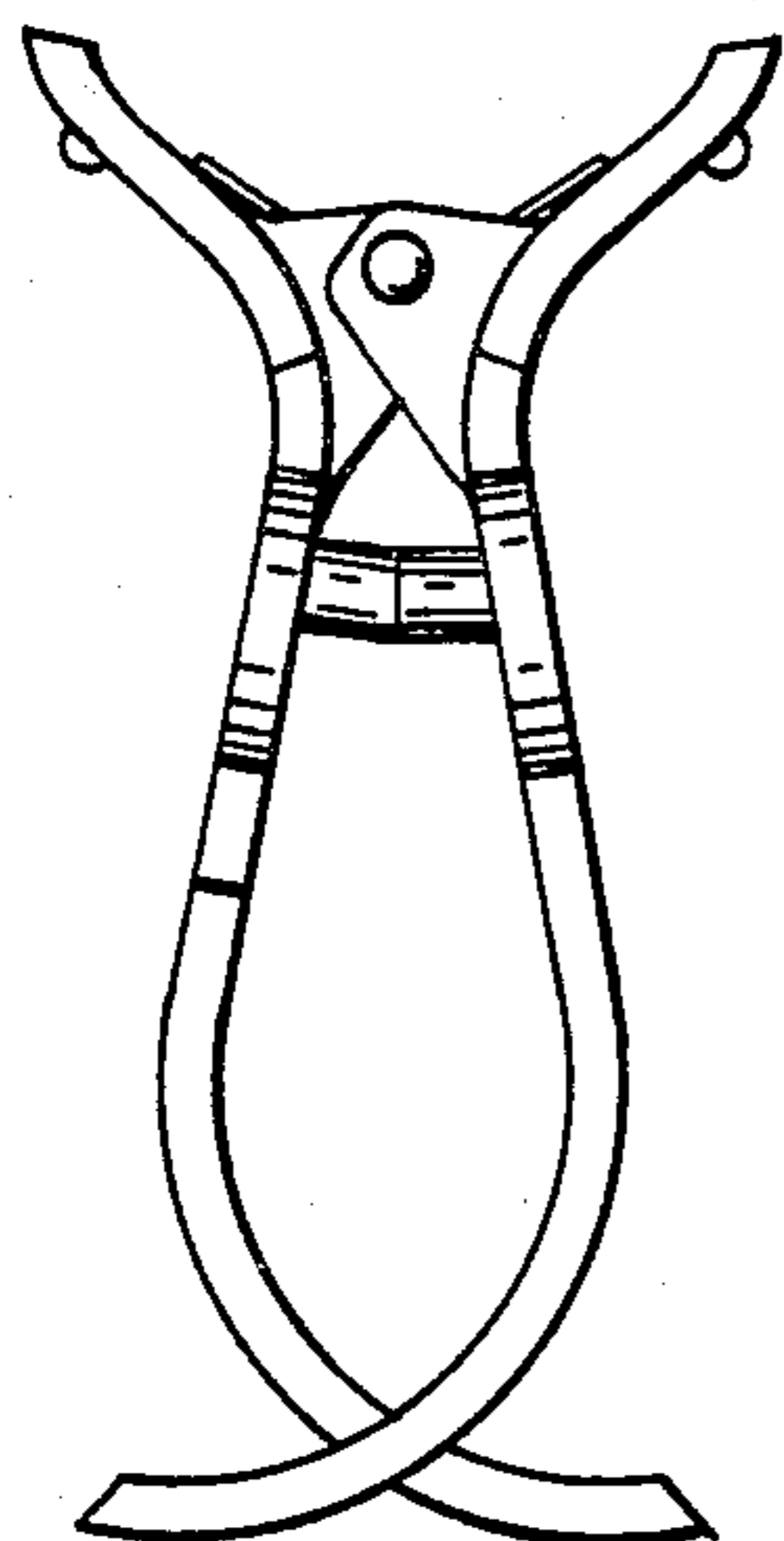

FIG. 5

