

United States Patent [19]

Gibbs

[11] Patent Number: Des. 293,427

[45] Date of Patent: ** Dec. 29, 1987

[54] **BICYCLE CARRIER**

[75] Inventor: Malcolm A. Gibbs, Parkhill, Canada

[73] Assignee: Twin Star Manufacturing Ltd.,
Parkhill, Canada

[**] Term: 14 Years

[21] Appl. No.: 749,521

[22] Filed: Jun. 27, 1985

[52] U.S. Cl. D12/158

[58] Field of Search D12/158, 114; D3/30.1,
D3/40; D7/70, 71; 224/30 A, 32 R, 36

[56] **References Cited**

U.S. PATENT DOCUMENTS

D. 179,756 2/1957 Bond D3/30.1

D. 203,565 1/1966 Hack et al. D7/70

D. 219,761 1/1971 Akers et al. D12/158

D. 237,483 11/1975 Uitz et al. D12/158

D. 288,305 2/1987 Latchman D12/114

4,295,345 10/1981 Atkinson D7/71

Primary Examiner—James M. Gandy

[57] **CLAIM**

The ornamental design for a bicycle carrier, as shown.

DESCRIPTION

FIG. 1 is a perspective view of a bicycle carrier, showing my new design;

FIG. 2 is a side elevation view thereof;

FIG. 3 is a top plan view thereof;

FIG. 4 is a rear elevation view thereof;

FIG. 5 is a front elevation view thereof; and,

FIG. 6 is a bottom plan view thereof.

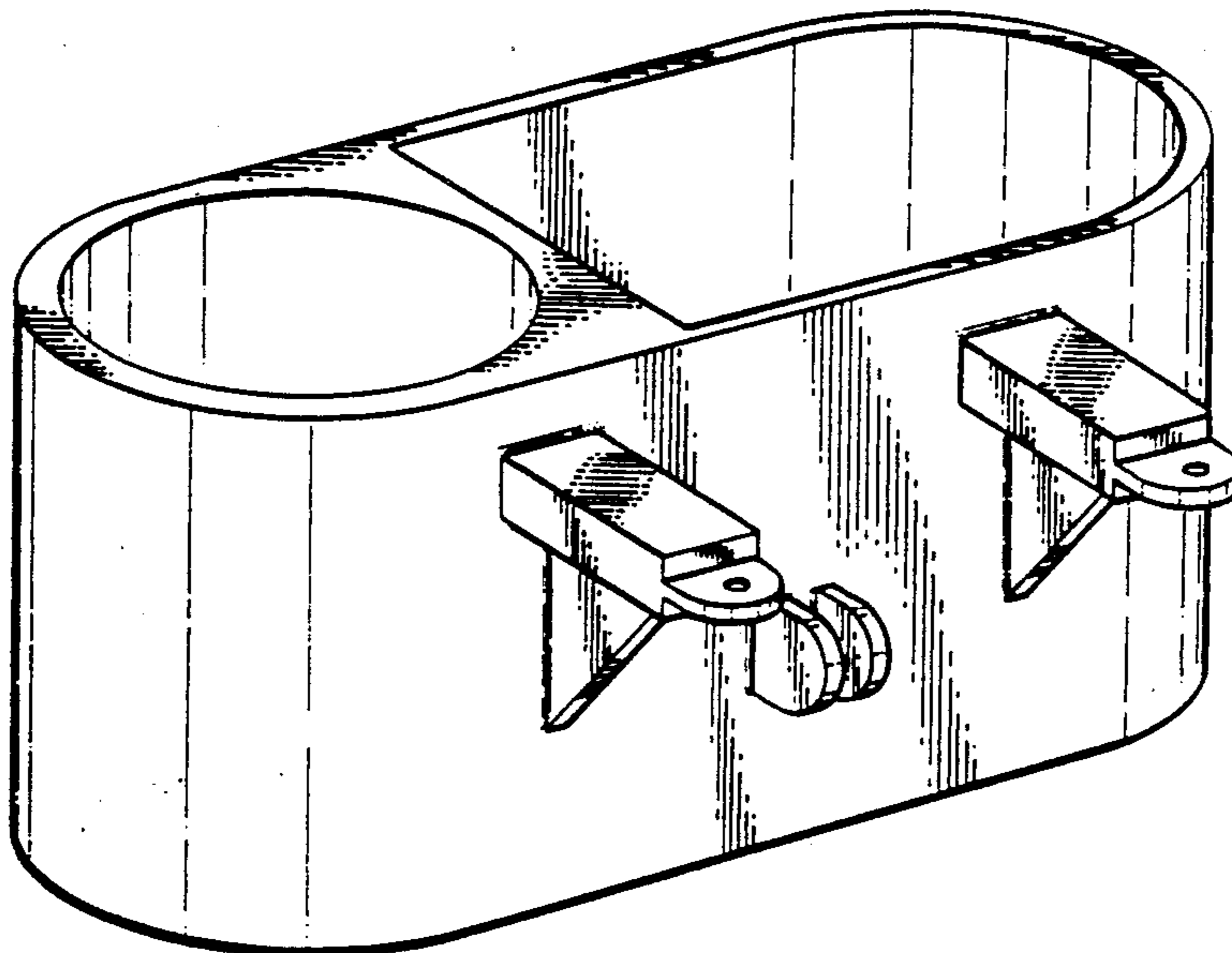

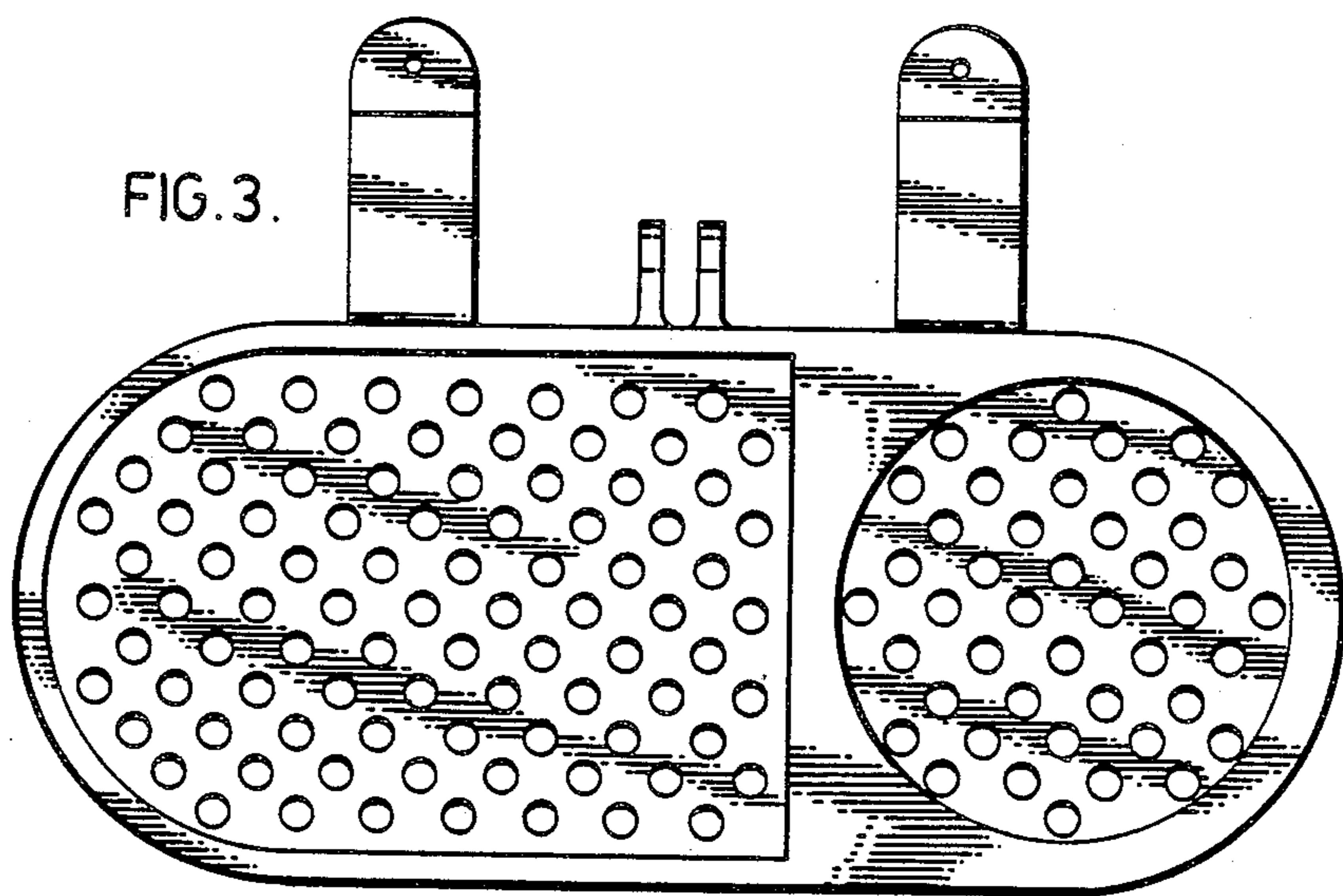
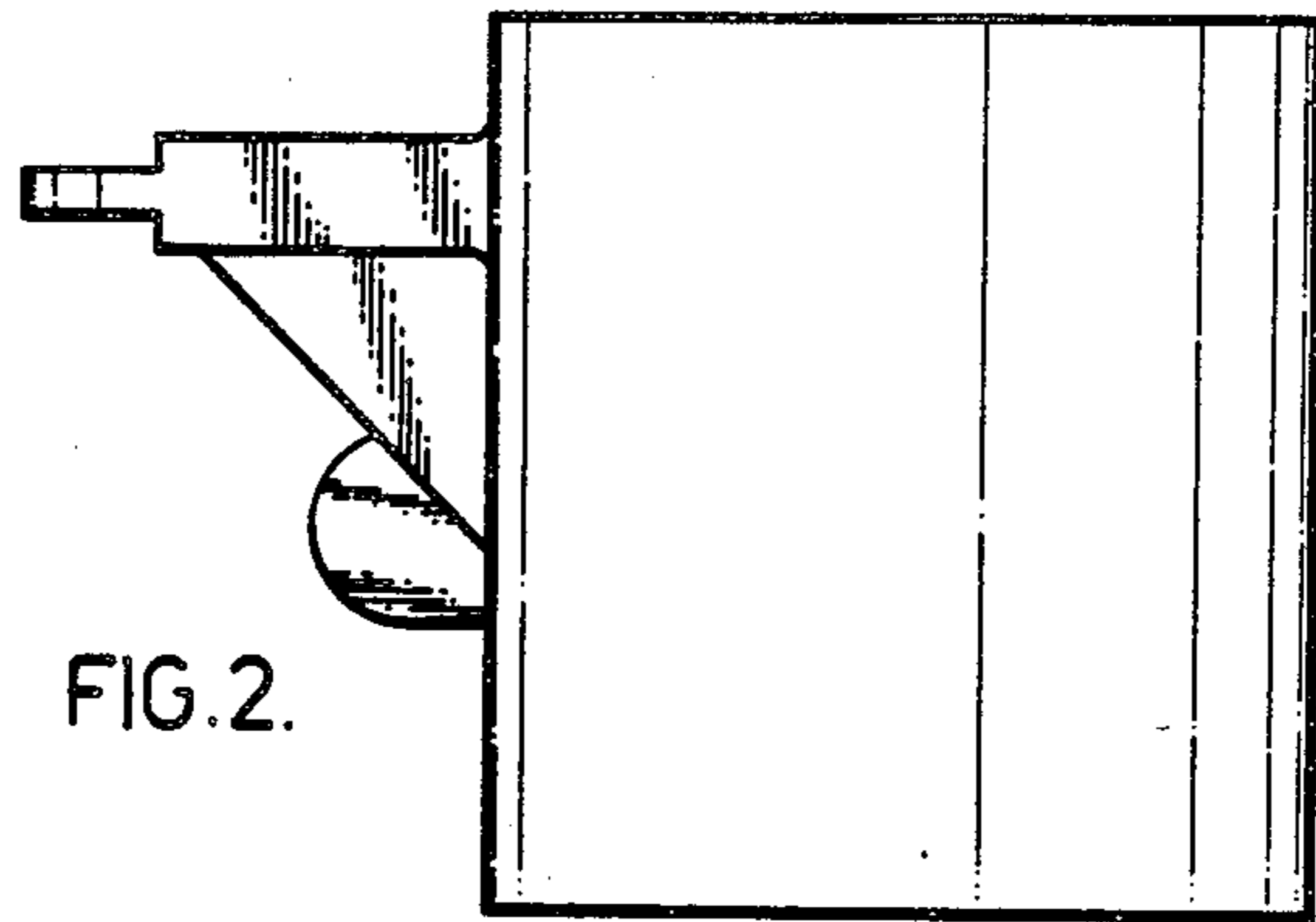
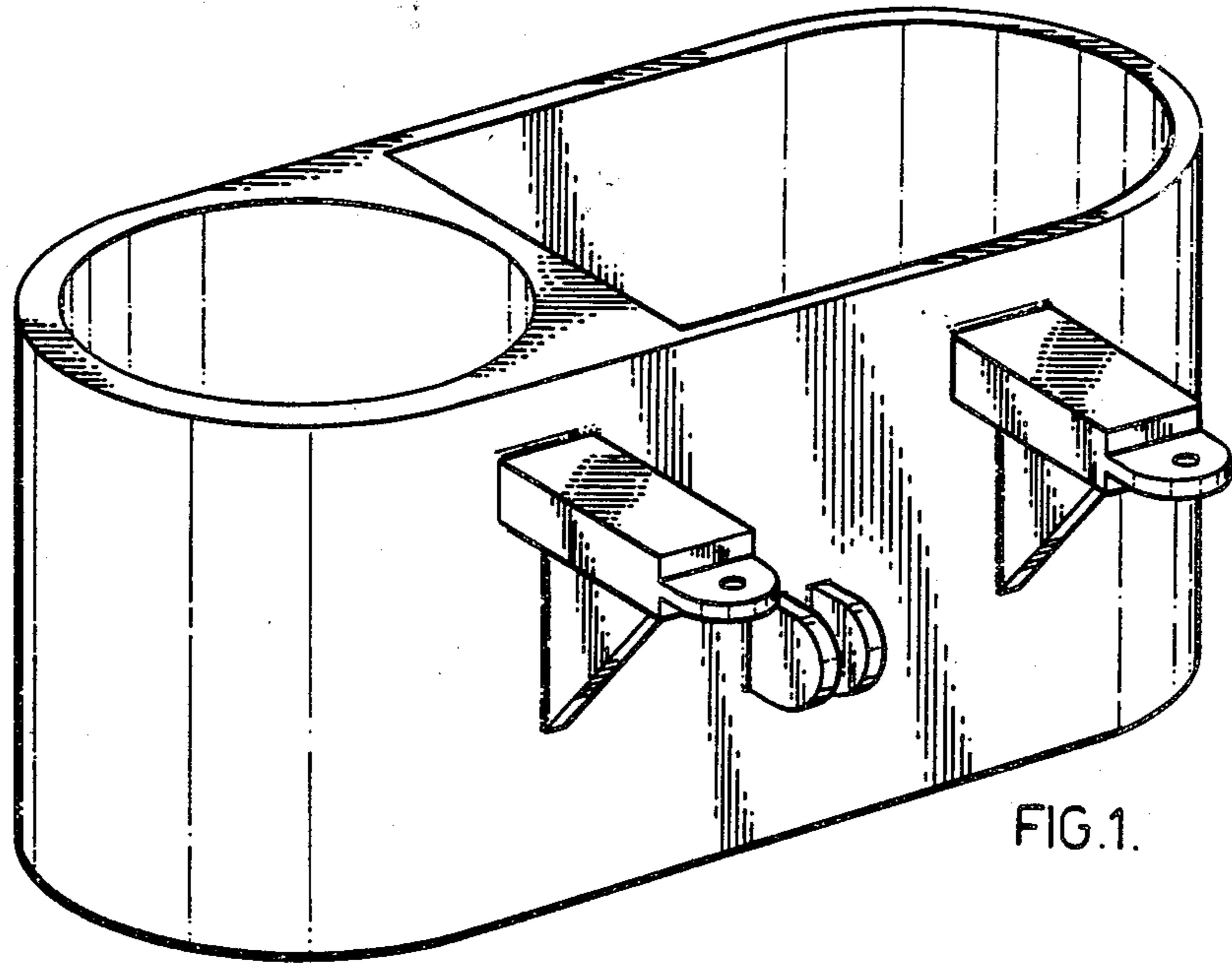

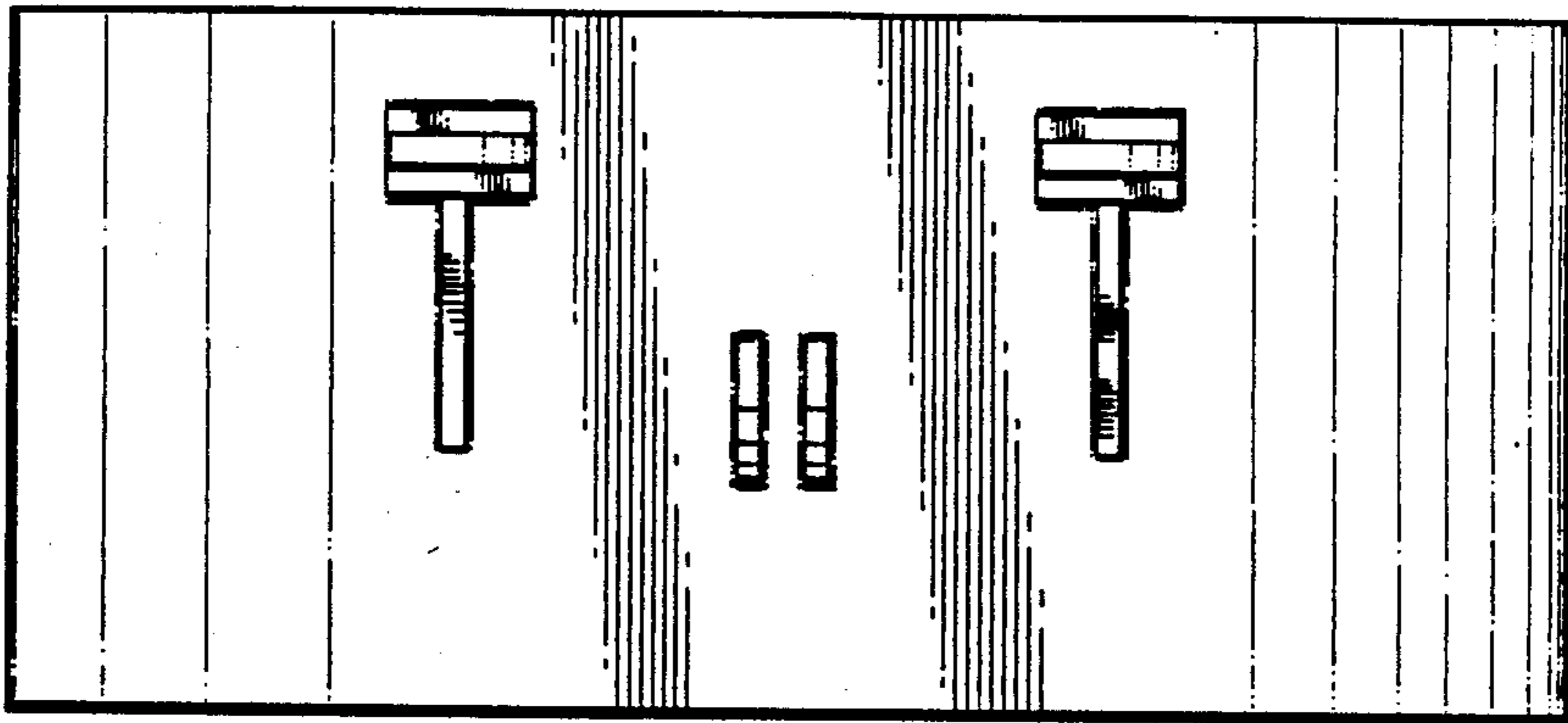

FIG. 4.

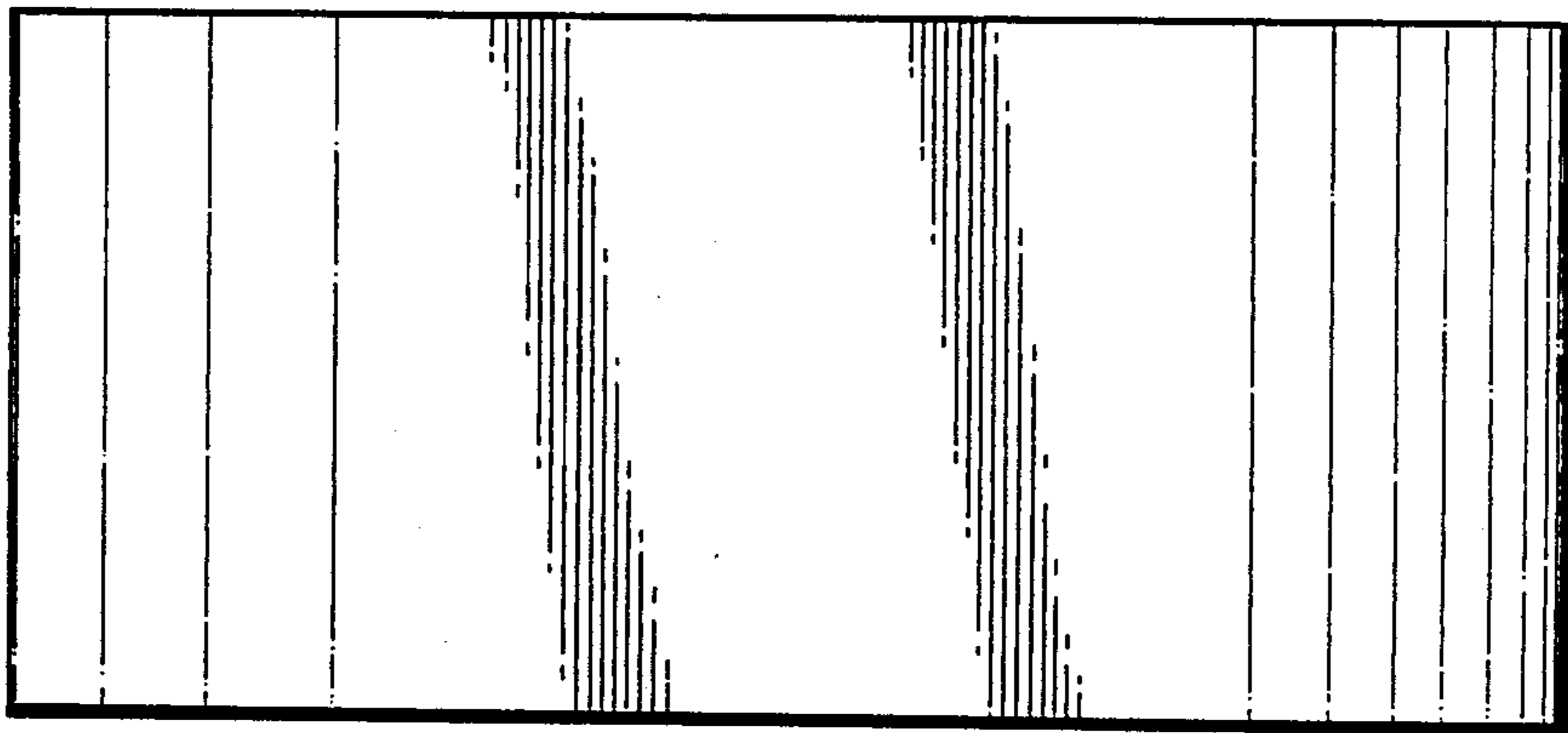

FIG. 5.

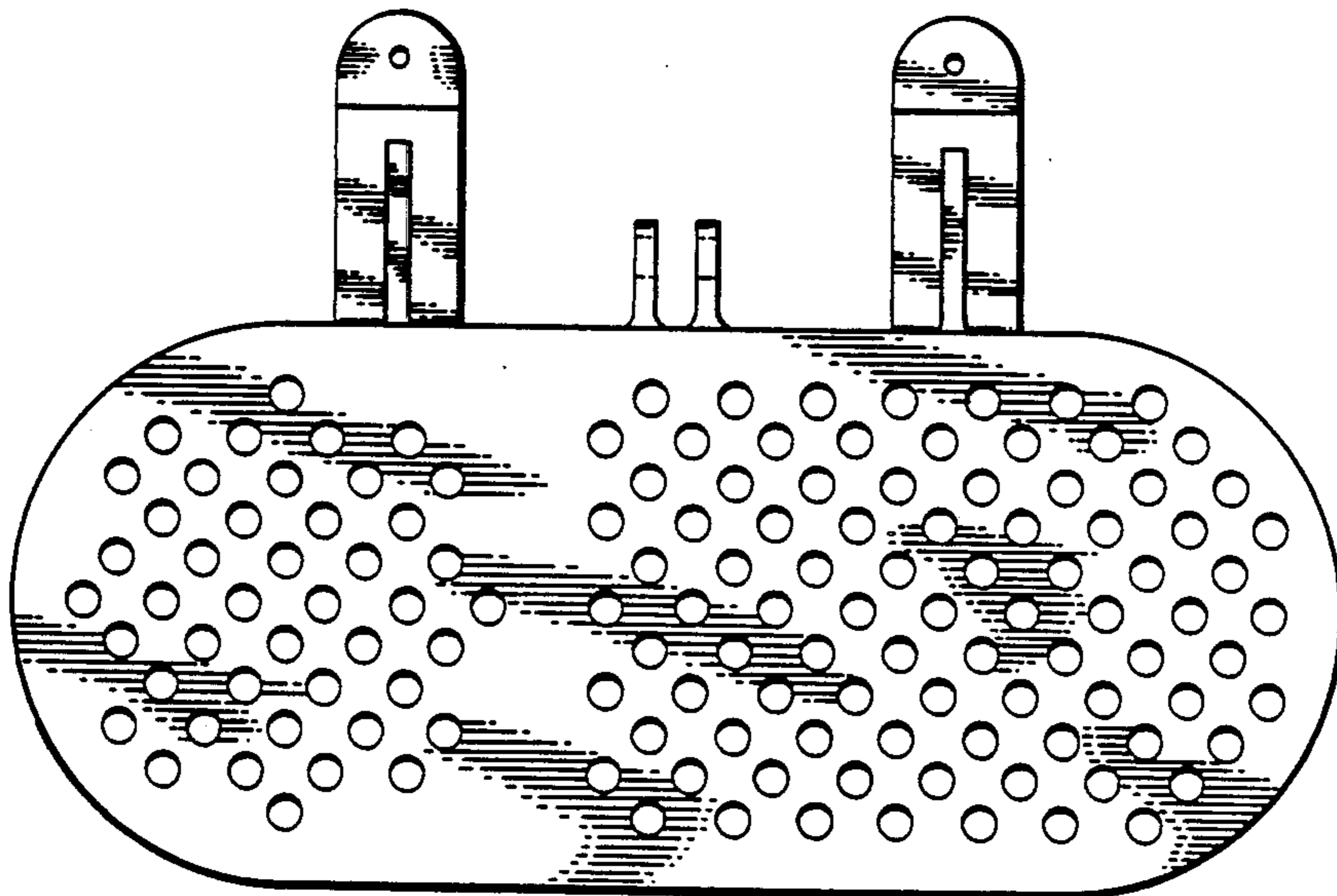

FIG. 6.