

[54] SET OF GRIP PANELS FOR A HANDGUN

[75] Inventors: William B. Ruger, Croydon, N.H.;
Lawrence L. Larson, Branford, Conn.

[73] Assignee: Sturm, Ruger & Company, Inc.,
Southport, Conn.

[**] Term: 14 Years

[21] Appl. No.: 683,786

[22] Filed: Dec. 19, 1984

[52] U.S. Cl. D22/108

[58] Field of Search D22/104, 105, 108;
42/59, 71 P, 85; 89/1.42

[56] References Cited
PUBLICATIONS

Gun Digest Book of Modern Gun Values, 1977, p. 72,
Remington Model 51; p. 13, Astra Model 900.

The Gun Digest Book of Exploded Firearms Drawings,
1977, p. 278, 7 m/m Nambu.

Guns Illustrated, 1978, p. 50, Model 951 Pistol.

Primary Examiner—Wallace R. Burke

Assistant Examiner—Ruth Takemoto

Attorney, Agent, or Firm—Pennie & Edmonds

[57] CLAIM

The ornamental design for set of grip panels for a hand-
gun, substantially as shown and described.

DESCRIPTION

FIG. 1 is a left side elevational view of a set of grip
panels for a handgun showing our new design;
FIG. 2 is a rear elevational view thereof;
FIG. 3 is a perspective view thereof; and
FIG. 4 is a right side elevational view thereof;
FIG. 5 is a front elevational view thereof;
FIG. 6 is an end elevational view thereof; and
FIG. 7 is an end elevational view thereof, of the oppo-
site end of FIG. 6.

The gun shown in broken lines in FIGS. 1-7 is for illus-
trative purposes only and forms no part of the claimed
design.

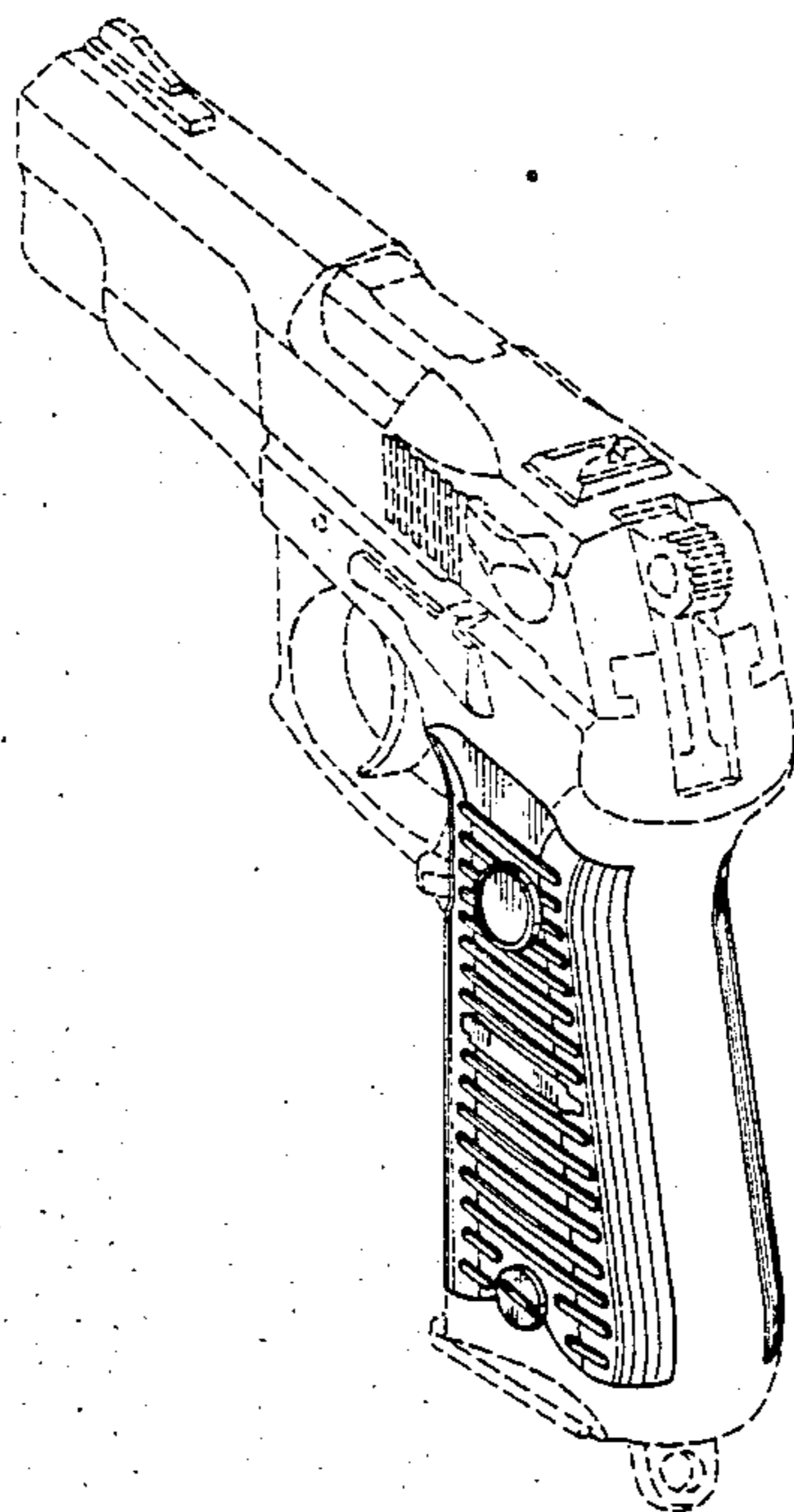

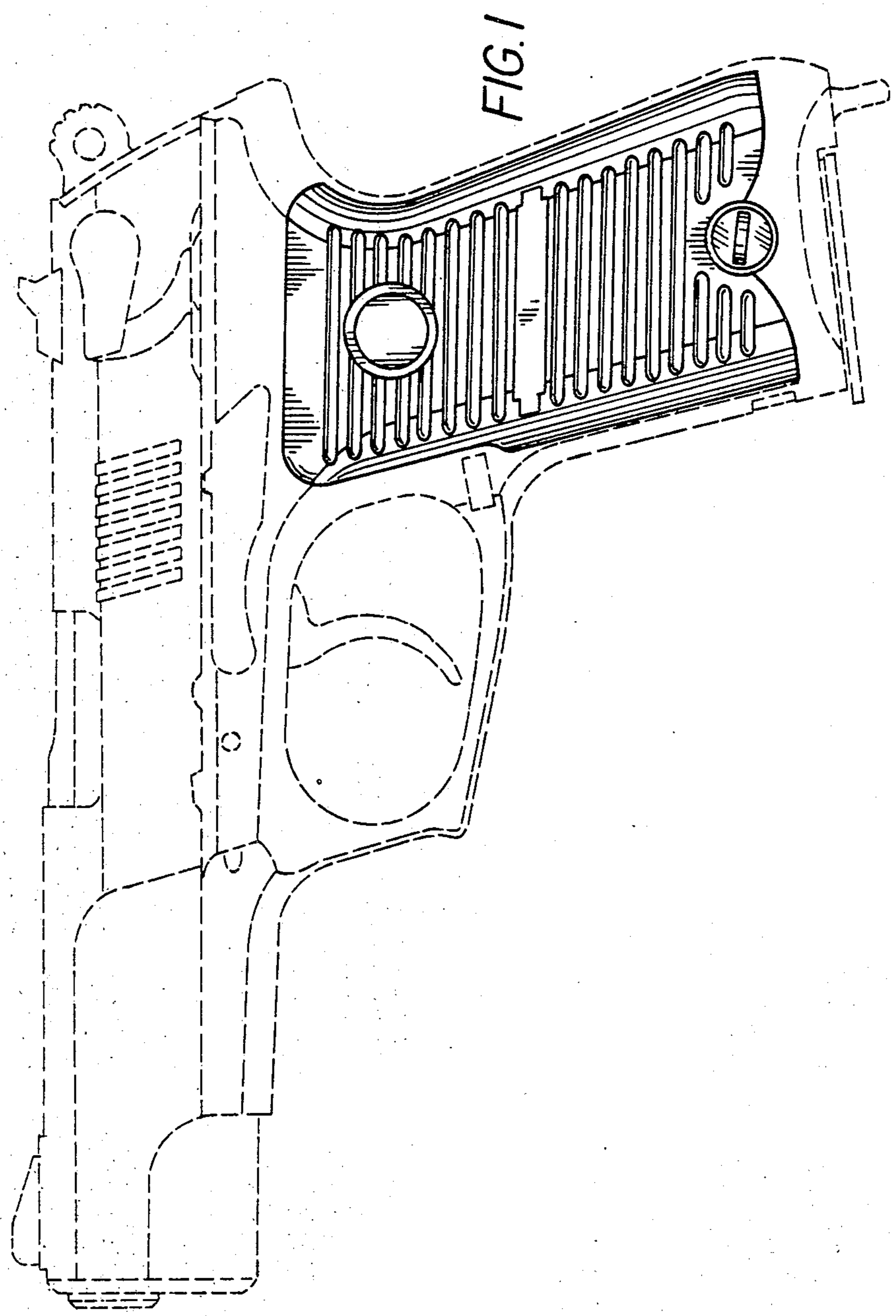
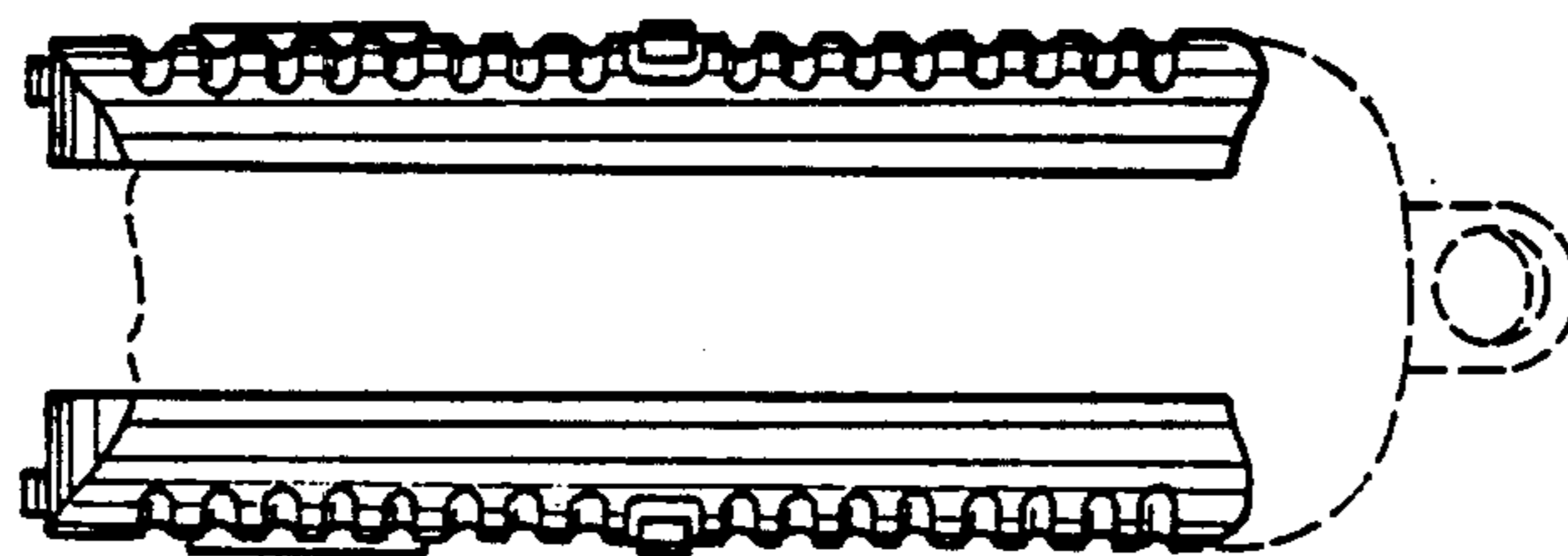

FIG. 2



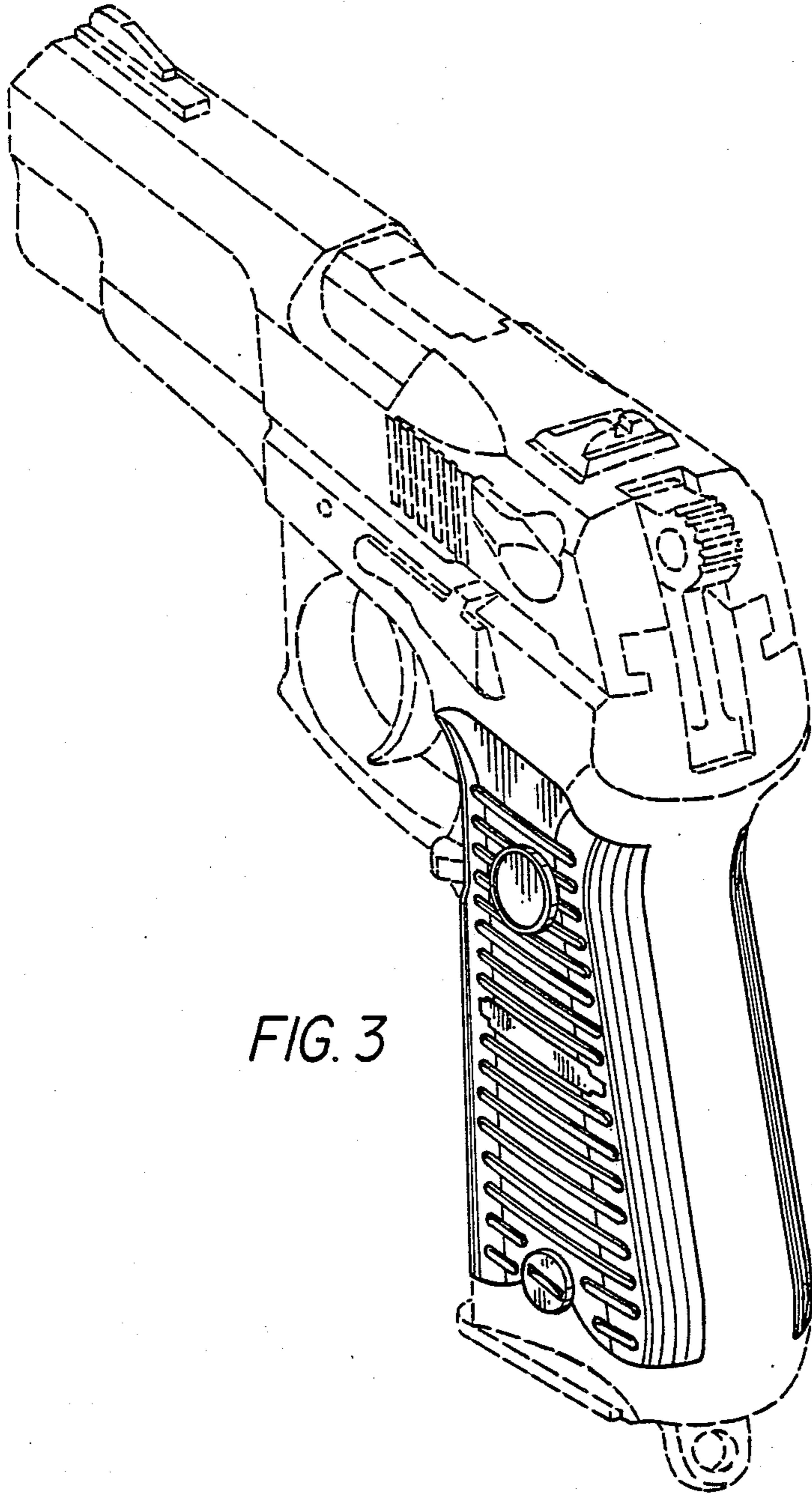
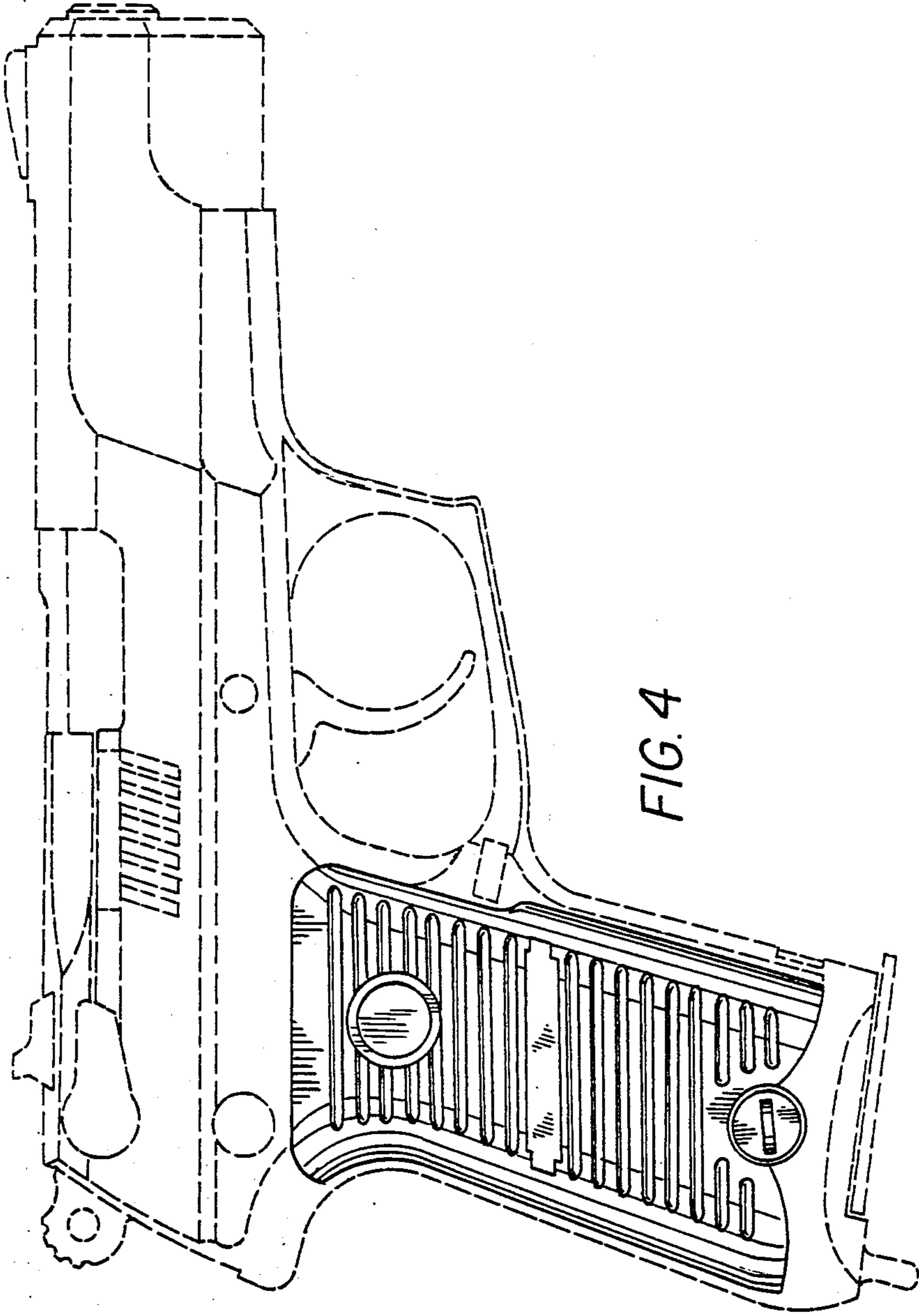

FIG. 3



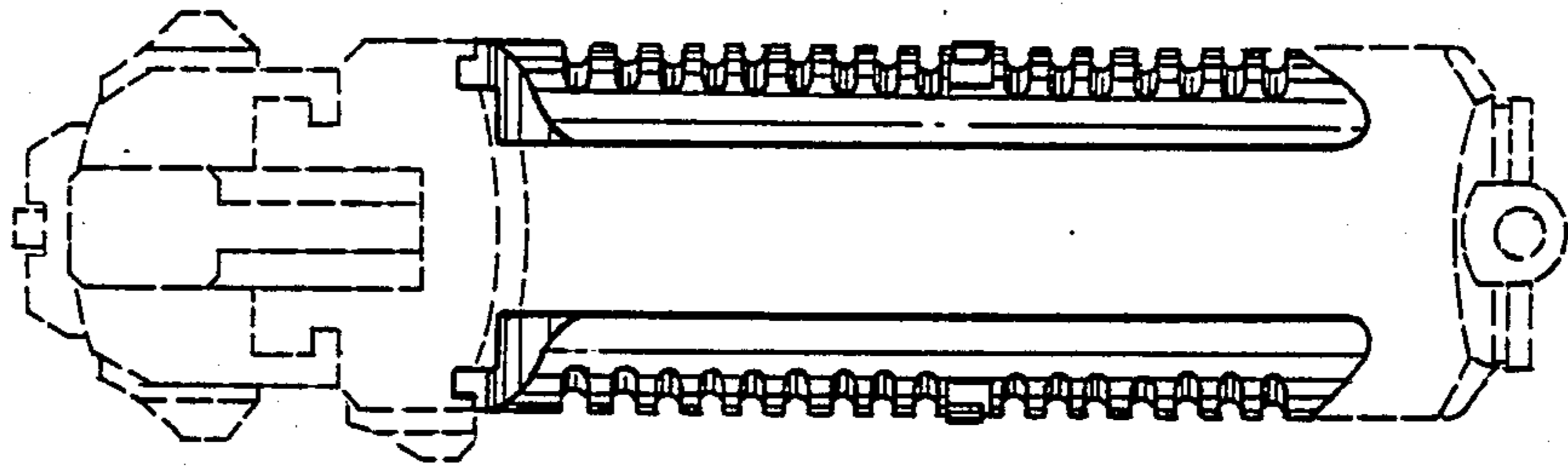

FIG. 5

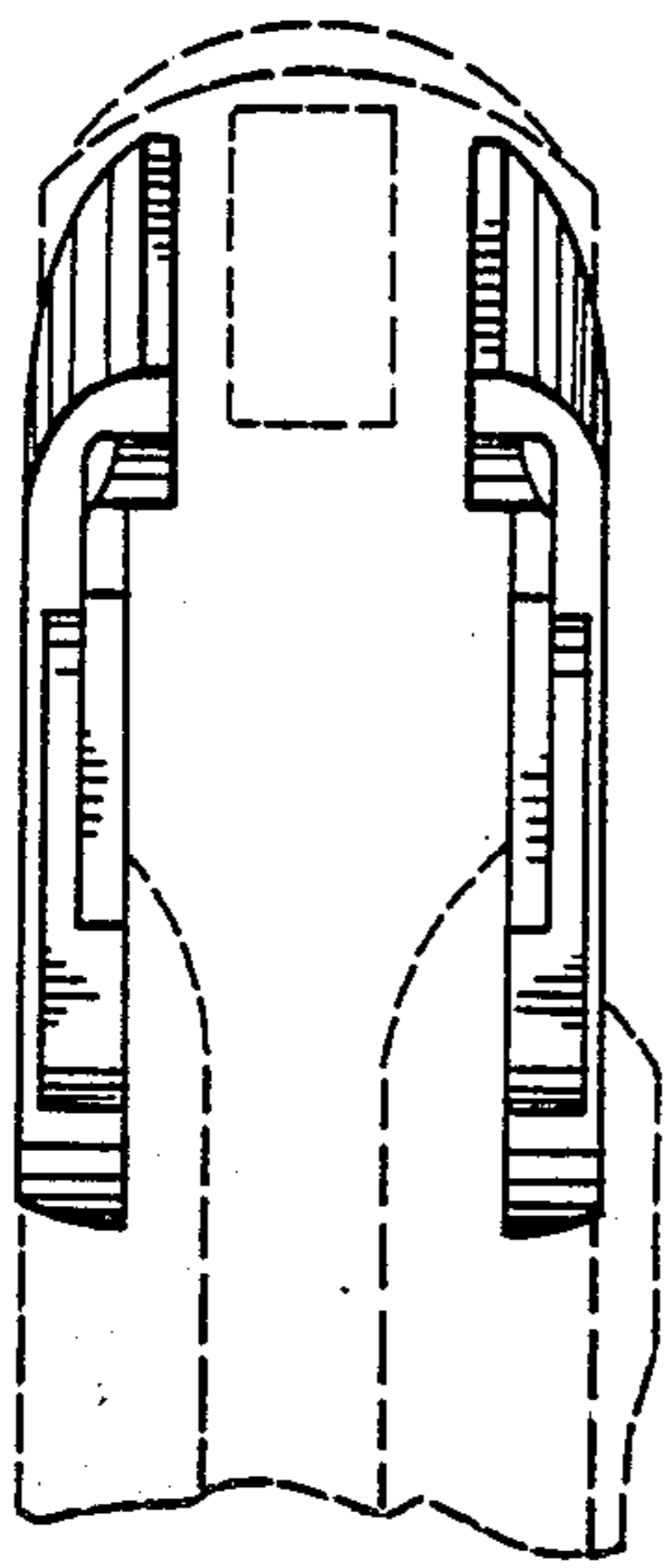

FIG. 6

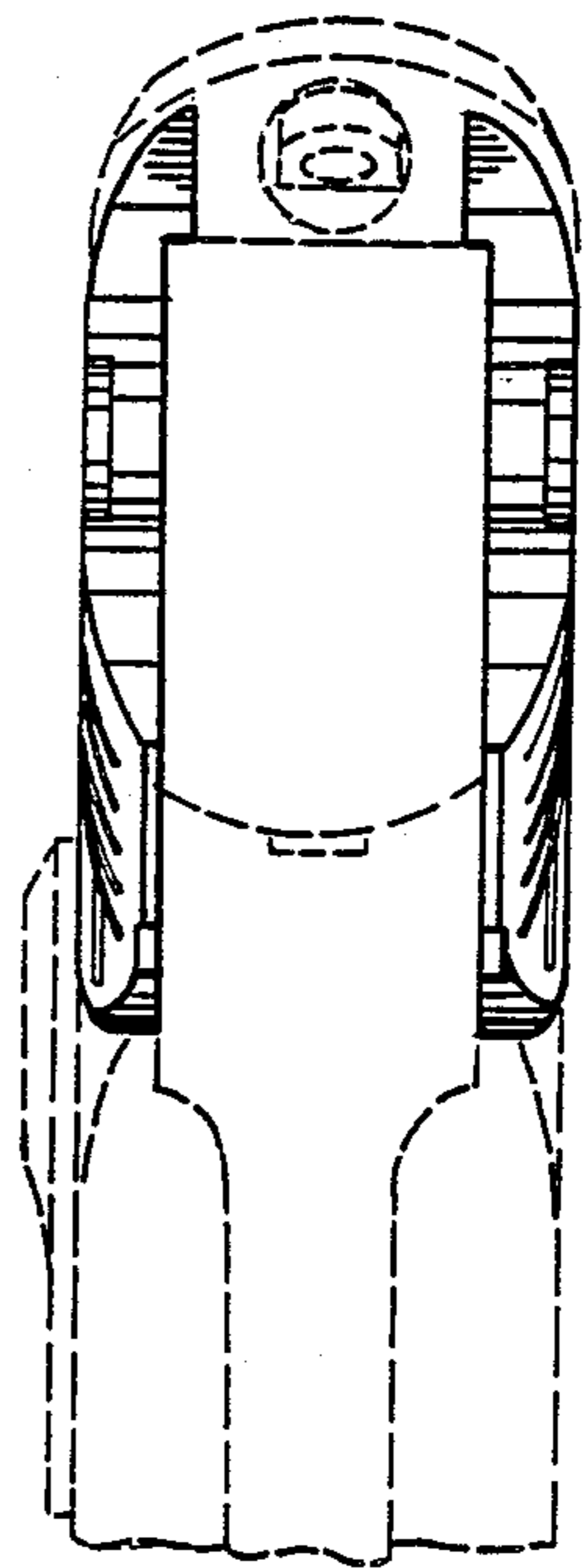

FIG. 7