

[54] FLOWER POT COVER

- [75] Inventors: Donald E. Weder; Erwin H. Weder, both of Highland, Ill.
- [73] Assignee: Highland Supply Corporation, Highland, Ill.
- [\*] Notice: The portion of the term of this patent subsequent to Dec. 15, 2001 has been disclaimed.
- [\*\*] Term: 14 Years
- [21] Appl. No.: 613,053
- [22] Filed: May 22, 1984
- [52] U.S. Cl. .... D11/164; D11/143
- [58] Field of Search ..... D11/143, 152, 164; D9/305, 306; 47/41, 66, 72; 150/52 R; 206/423; 229/3.5 MF, 4.5, 87 P; 248/27.8; 428/35, 542.6

[56] References Cited

U.S. PATENT DOCUMENTS

D. 254,659	4/1980	Karotseris .....	D11/02
1,069,675	8/1913	Claussen .	
1,446,563	2/1923	Hughes .	
1,868,853	7/1932	Sievers .	
2,302,259	11/1942	Rotlifuss .....	41/10
2,355,559	8/1944	Renner .....	229/8
2,482,981	9/1949	Kamrass .....	41/13
2,967,652	1/1961	Canfield et al. ....	229/5.5
3,022,605	2/1962	Reynolds .....	47/58
3,271,922	9/1966	Wallerstein et al. ....	53/3
3,488,022	1/1970	Vittori .....	248/152
3,542,616	11/1970	Cain et al. ....	156/224
3,962,503	6/1976	Crawford .....	428/40
4,043,077	8/1977	Stonehocker .....	47/66
4,118,890	10/1978	Shore .....	47/28 R
4,170,618	10/1979	Adams .....	264/101
4,216,620	8/1980	Weder et al. ....	47/72
4,300,312	11/1981	Weder et al. ....	47/72
4,508,223	4/1985	Catrambone .....	206/423

OTHER PUBLICATIONS

- "Redi-Wrap" Flower Pot; Curtis Wagner Co., Inc.; date unknown, exhibit A.
- Flower Pot Covers; Highland Supply Corp.; never available to public; exhibit F.
- Flower Pot Wrappings; various sources; no date known; exhibit G.
- Straw-like Pot Cover; source unknown; date unknown; exhibit H.
- Flower Pot Cover; source unknown; date unknown; item 3.
- Pot Cover; Jacobson Pot Cover Co.; exhibit B; date unknown.
- Platform Pot Dresser; John Raisen Corp.; exhibit C; date unknown.
- Floral Decor Cover; John Henry Co.; exhibit D; date unknown.
- Pot Cover; Klerk's Plastic Industrie B. V.; exhibit E; date unknown.
- Pot Covers; unrelated and unknown; exhibits L & M; date unknown.
- Straw-like Cover; origin unknown; exhibit N; date unknown.
- Basket-like Cover; origin unknown; exhibit O; date unknown.

Primary Examiner—B. J. Bullock  
 Attorney, Agent, or Firm—Dunlap, Coddling & Peterson

[57] CLAIM

The ornamental design for a flower pot cover, as shown and described.

DESCRIPTION

FIG. 1 is a top plan view of the flower pot cover showing our new design.  
 FIG. 2 is a front elevational view thereof.  
 FIG. 3 is a rear elevational view thereof.  
 FIG. 4 is a side elevational view thereof.  
 FIG. 5 is a side elevational view similar to FIG. 4, but showing the opposite side thereof.  
 FIG. 6 is a bottom plan view thereof.  
 The flower pot cover has no substantial thickness.

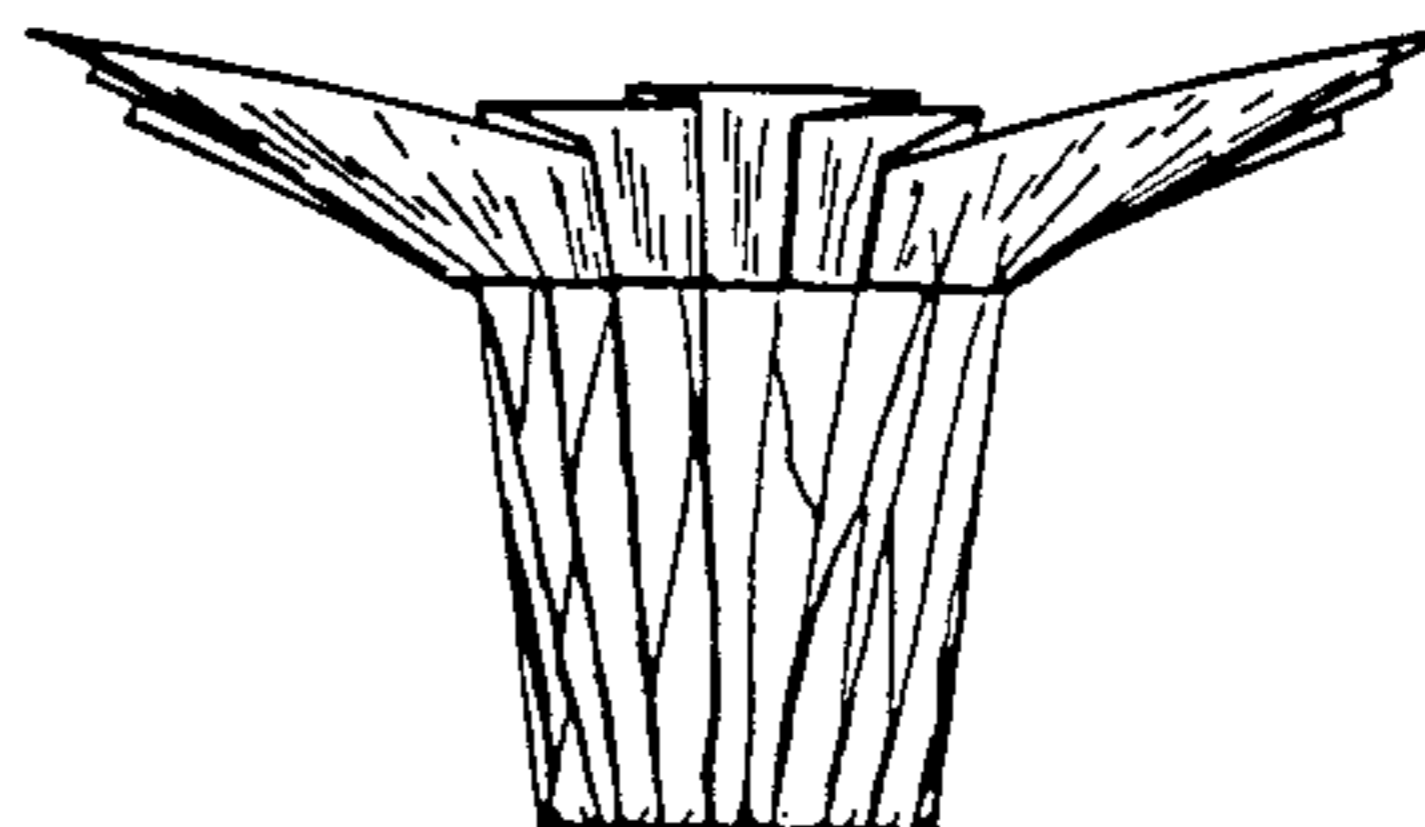
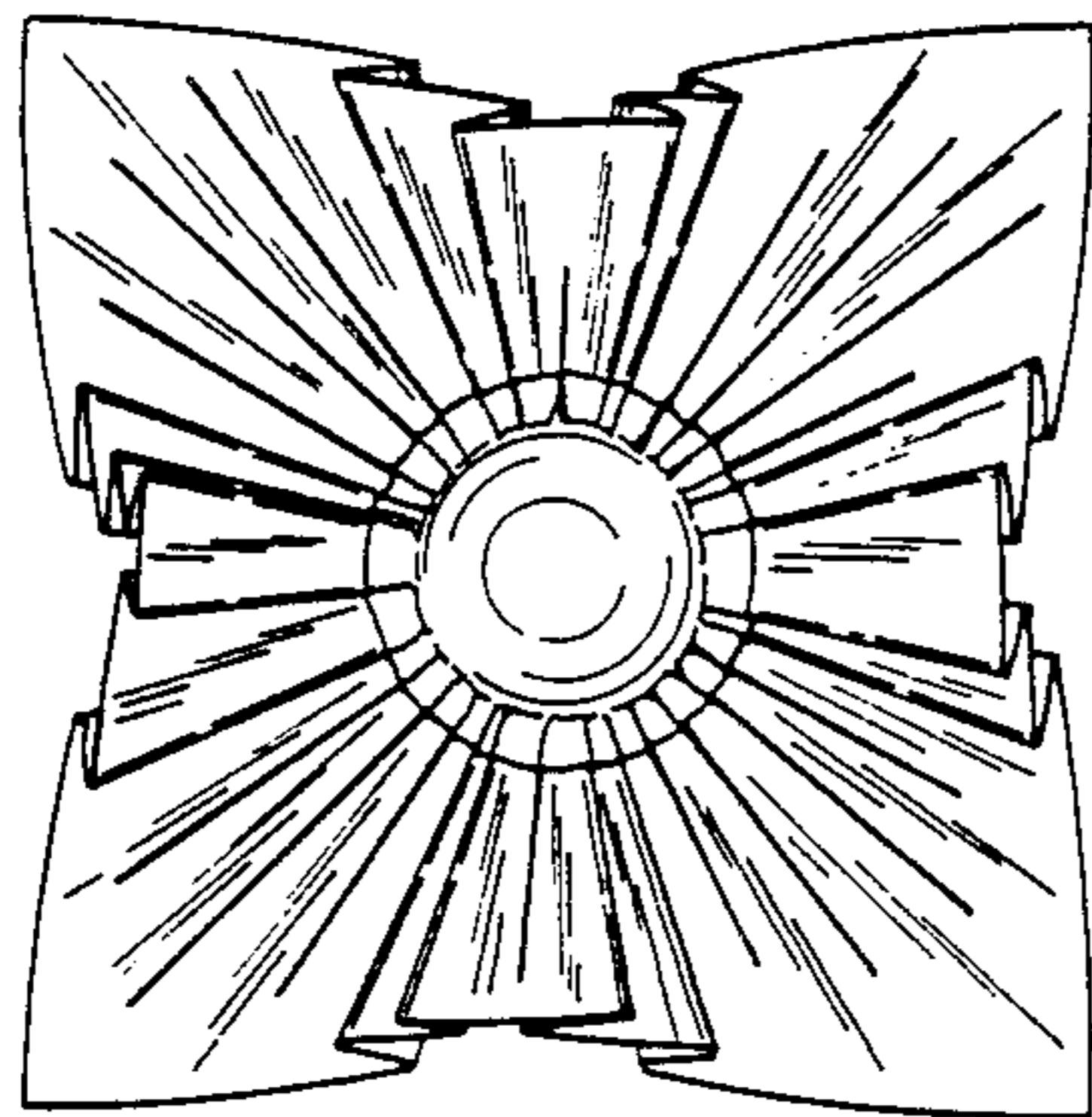

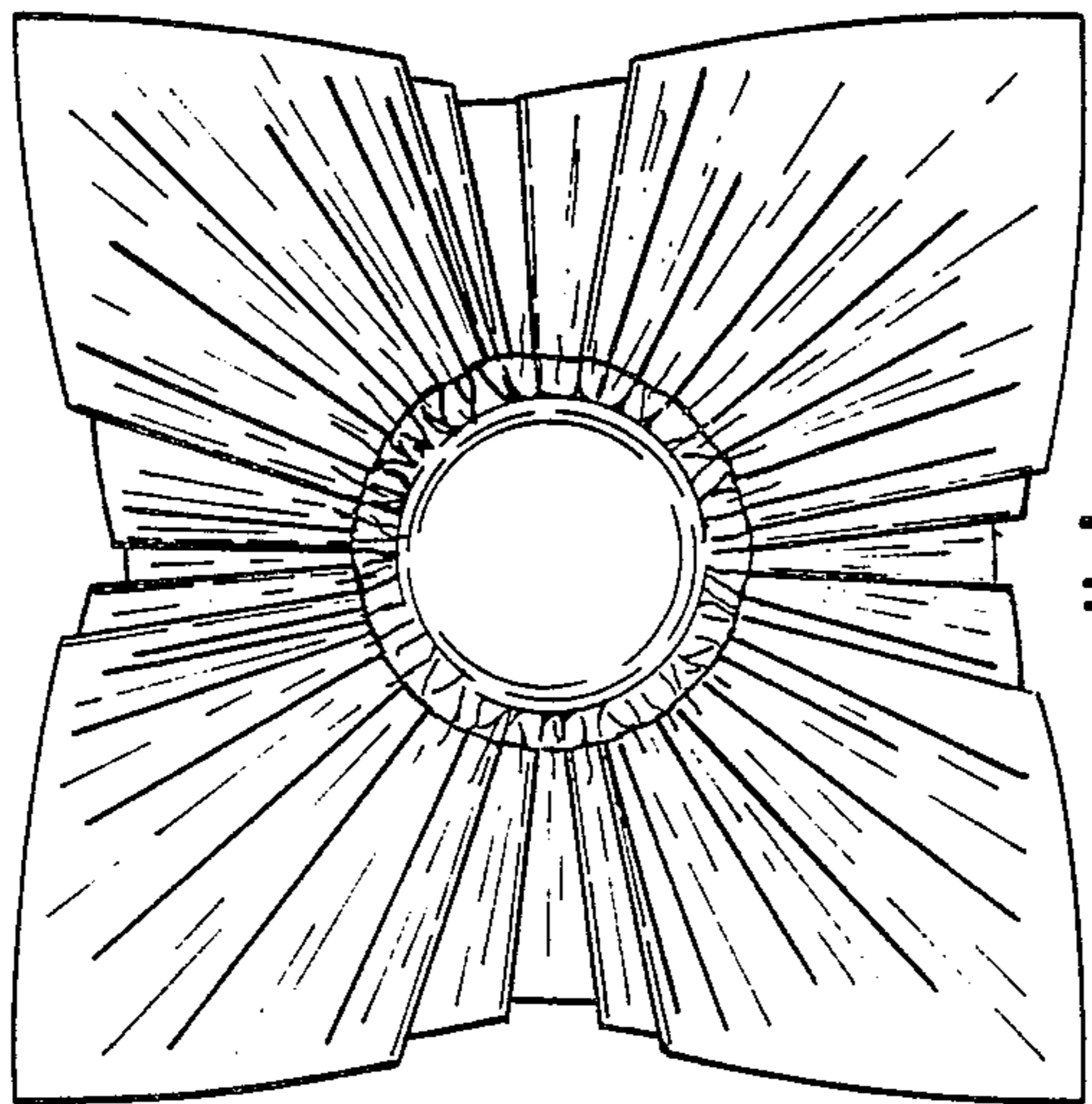
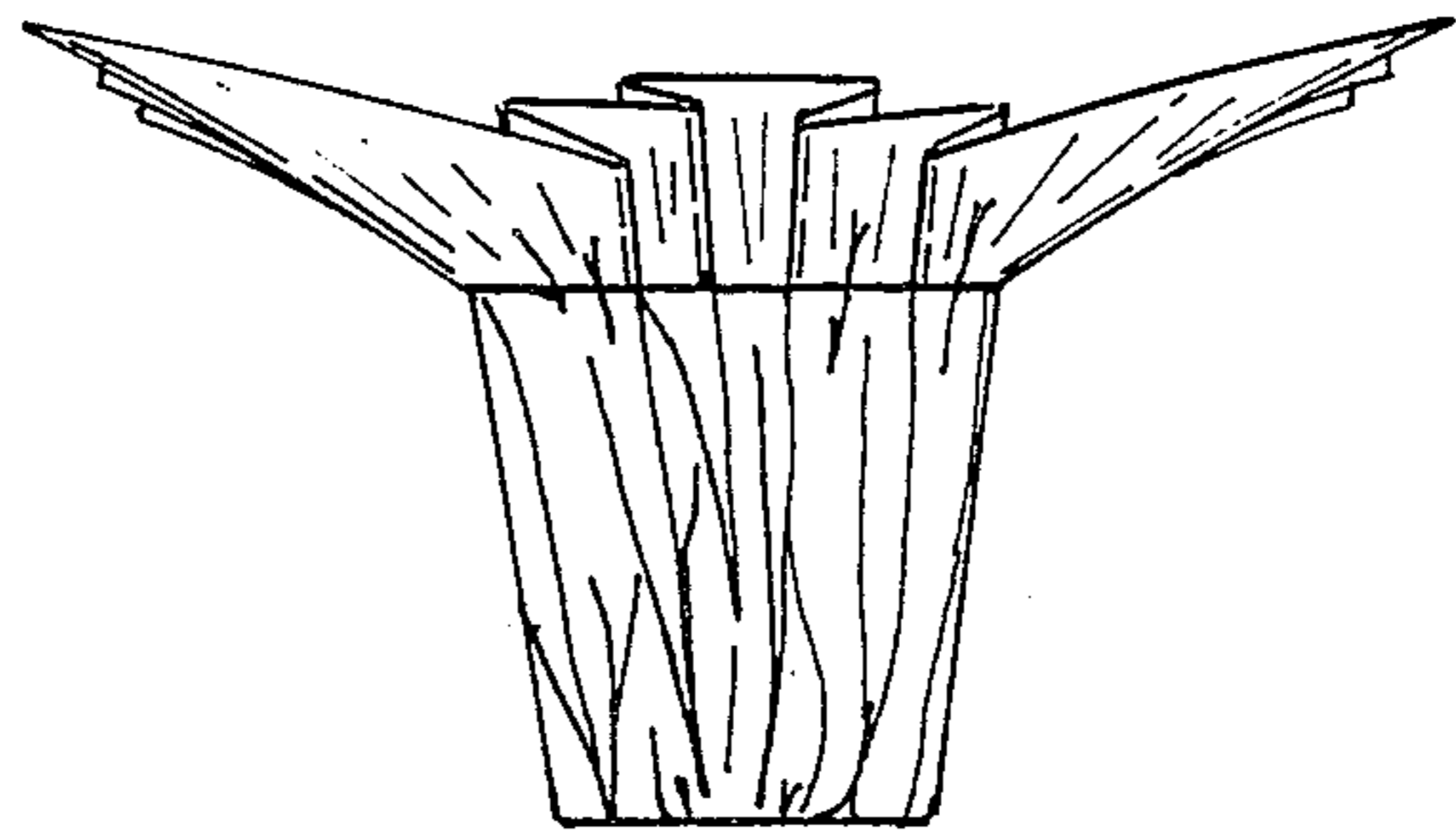
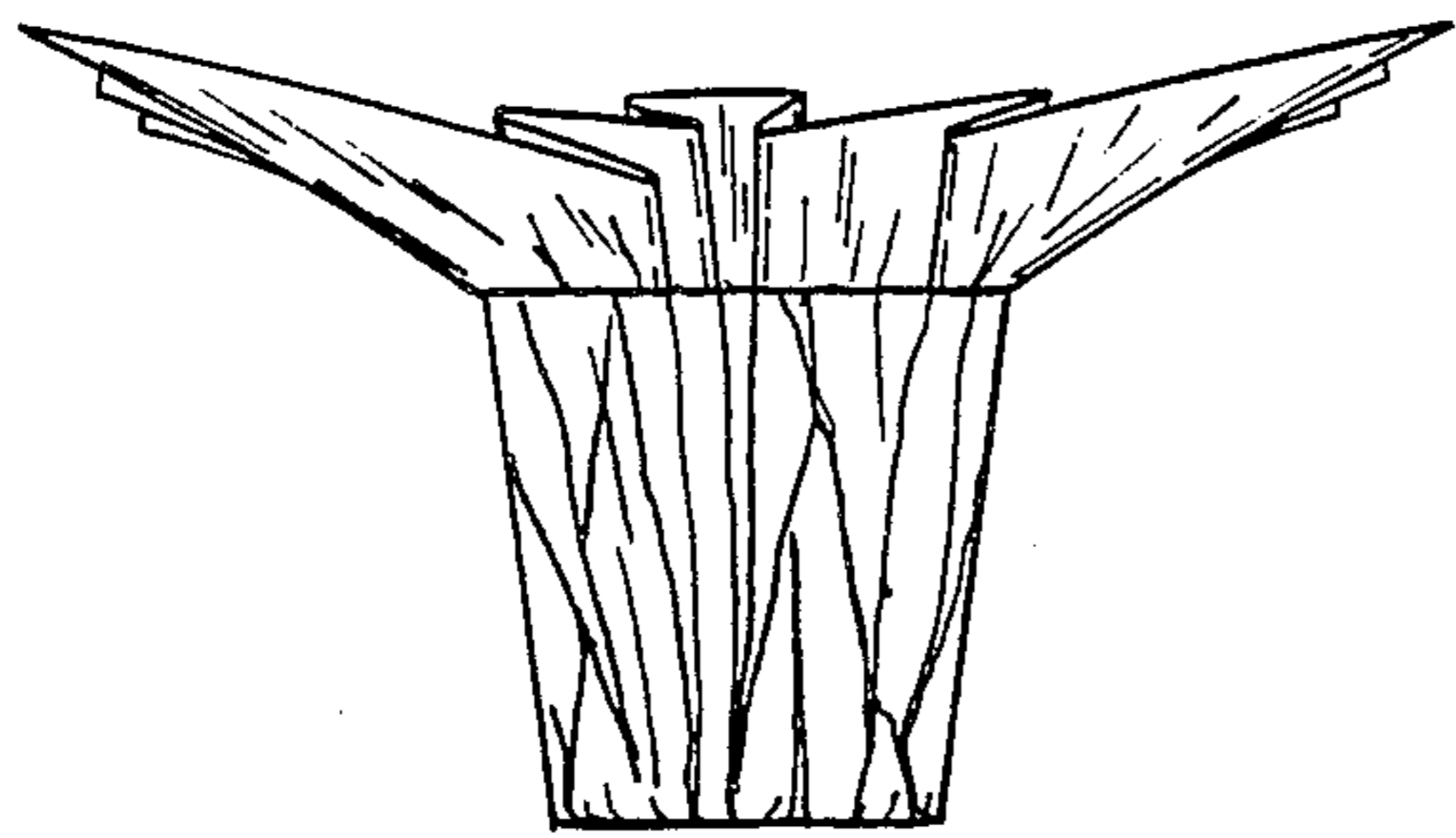
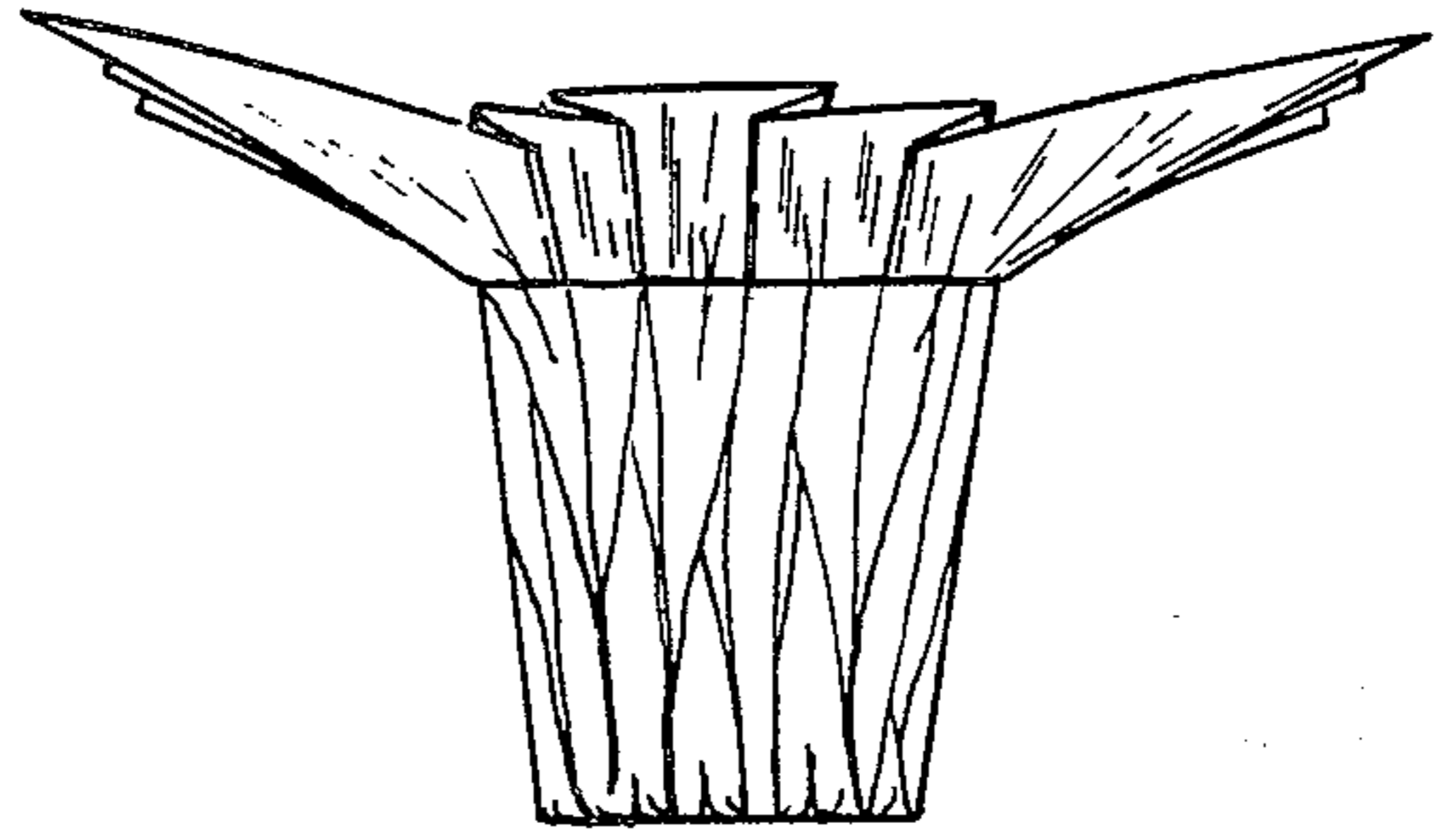
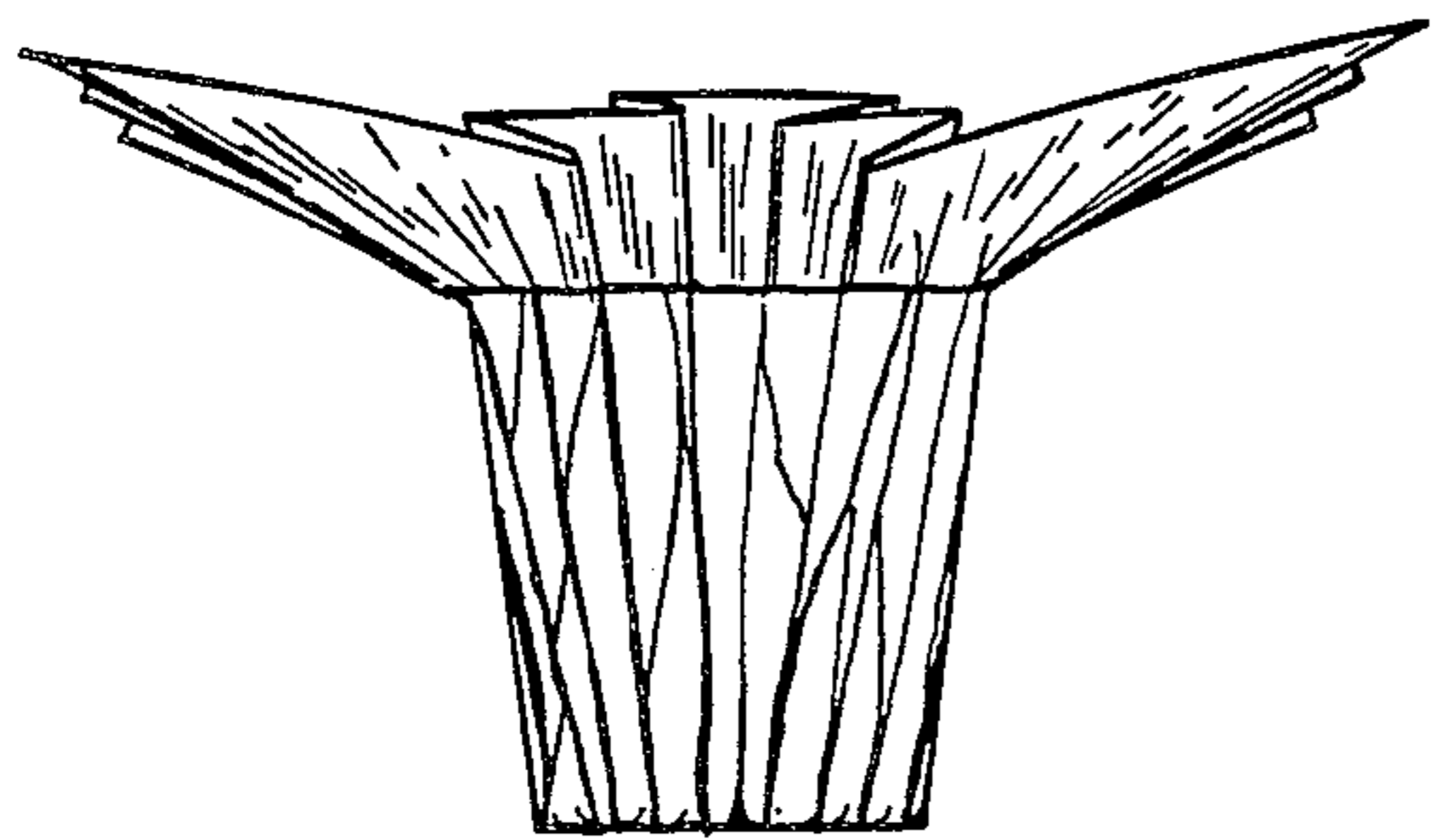
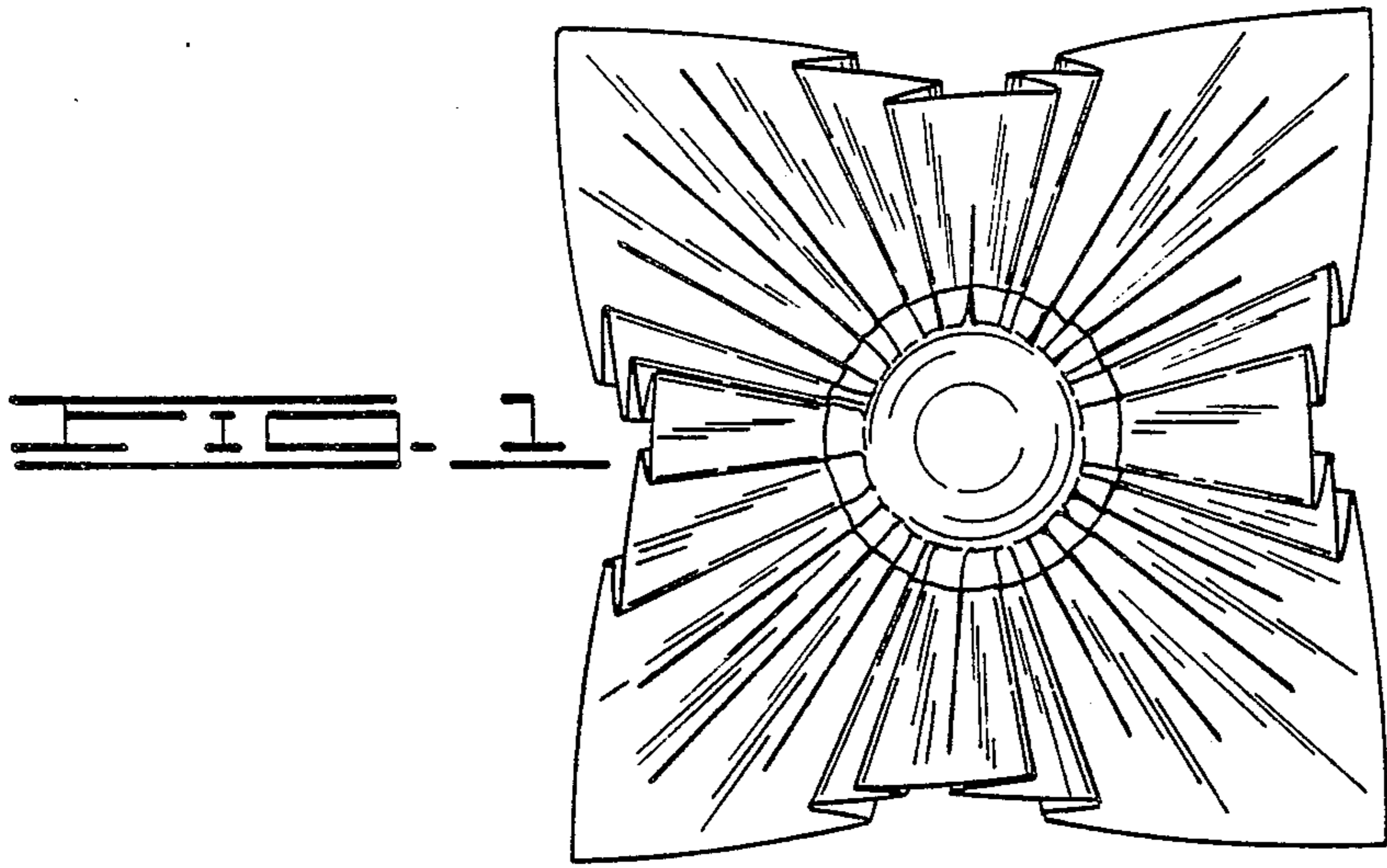

FIG. 6