

[54] FLOWER POT COVER

[75] Inventors: Donald E. Weder; Erwin H. Weder, both of Highland; Robert C. Abrams, Edwardsville, all of Ill.

[73] Assignee: Highland Supply Corporation, Highland, Ill.

[*] Notice: The portion of the term of this patent subsequent to Dec. 15, 2001 has been disclaimed.

[**] Term: 14 Years

[21] Appl. No.: 652,882

[22] Filed: Sep. 21, 1984

Related U.S. Application Data

[63] Continuation-in-part of Ser. No. 613,053, May 22, 1984.

[52] U.S. Cl. D11/164; D11/143

[58] Field of Search D11/143, 152, 164; D9/305, 306, 444, 455; 47/41, 66, 72; 150/52 R; 206/423; 229/3.5 MF, 4.5, 87 P; 428/35, 542.6; 248/27.8

[56] References Cited

U.S. PATENT DOCUMENTS

557,526	3/1896	Egge .	
2,204,664	6/1940	Clark .	
2,622,380	12/1952	Snyder .	
2,780,401	2/1957	Stevens .	
3,185,502	6/1965	Little .	
3,318,748	5/1967	Hurst .	
3,466,214	9/1969	Polk et al. .	
3,775,932	12/1973	Jeney .	
3,791,902	2/1974	Hanke et al. .	
4,508,223	4/1985	Catrambone	206/423

OTHER PUBLICATIONS

"Redi-Wrap" Flower Pot; Curtis Wagner Co., Inc; date unknown, exhibit A.
 Flower Pot Covers; Highland Supply Corp; never available to public; exhibit F.
 Flower Pot Wrappings; various sources; no date known; exhibit G.
 Straw-Like Pot Cover; source unknown; date unknown; exhibit H.
 Flower Pot Cover; source unknown; date unknown; item 3.
 Pot Cover; Jacobson Pot Cover Co; exhibit B; date unknown.
 Platform Pot Dresser; John Raisen Corp; exhibit C; date unknown.
 Floral Decor Cover; John Henry Co; exhibit D; date unknown.
 Pot Cover; Klerk's Plastic Industrie B.V.; exhibit E; date unknown.
 Pot Covers; unrelated and unknown; exhibits L & M; date unknown.
 Straw-Like Cover; origin unknown; exhibit N; date unknown.
 Basket-Like Cover; origin unknown; exhibit O; date unknown.

Primary Examiner—B. J. Bullock
Attorney, Agent, or Firm—Dunlap, Coddling & Peterson

[57] CLAIM

The ornamental design for a flower pot cover, substantially as shown and described.

DESCRIPTION

FIG. 1 is a top plan view of a flower pot cover showing our new design.
 FIG. 2 is a front elevational view thereof.
 FIG. 3 is a rear elevational view thereof.
 FIG. 4 is a side elevational view thereof.
 FIG. 5 is a side elevational view similar to FIG. 4, but showing the side opposite that shown in FIG. 4.
 FIG. 6 is a bottom plan view thereof.
 The layers of the flowers pot cover have no substantial thickness.

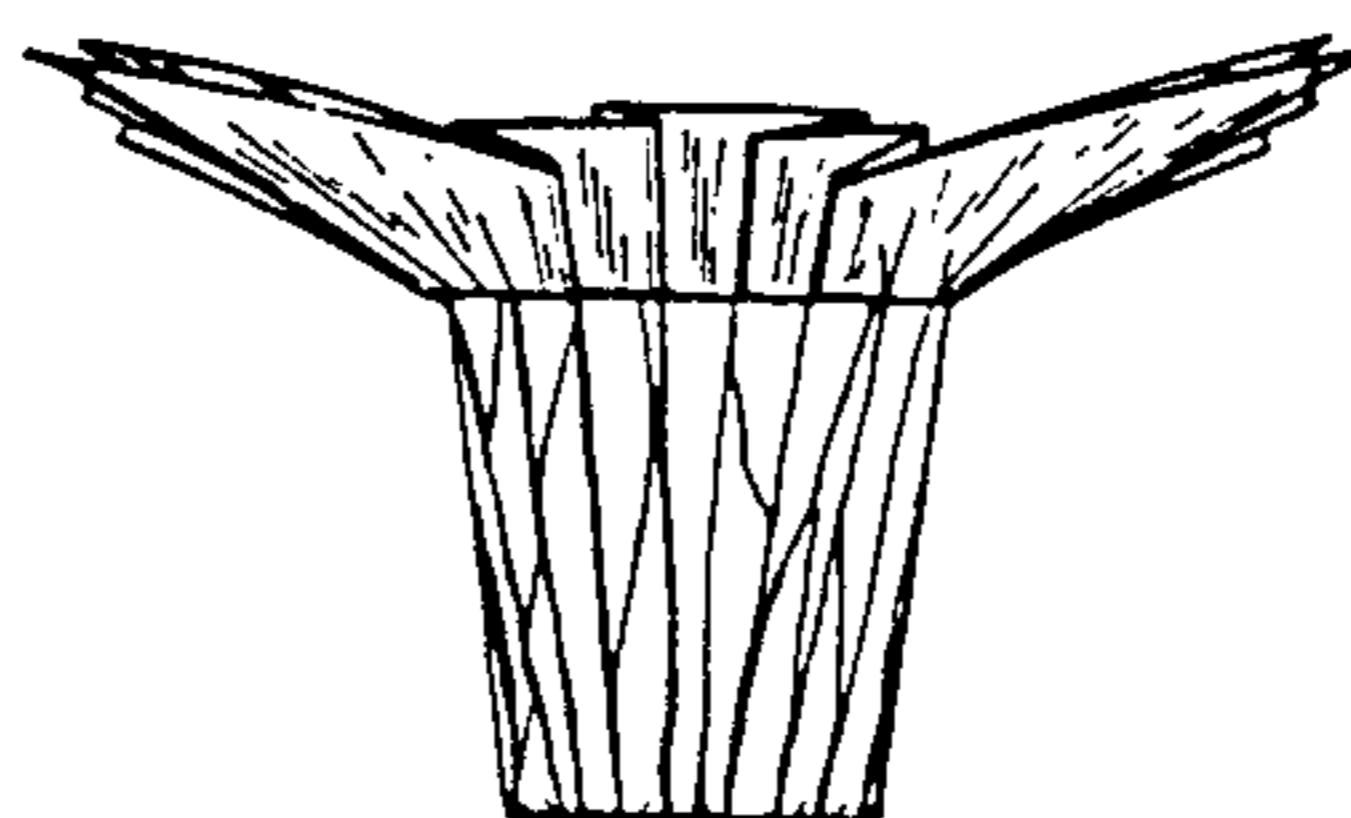
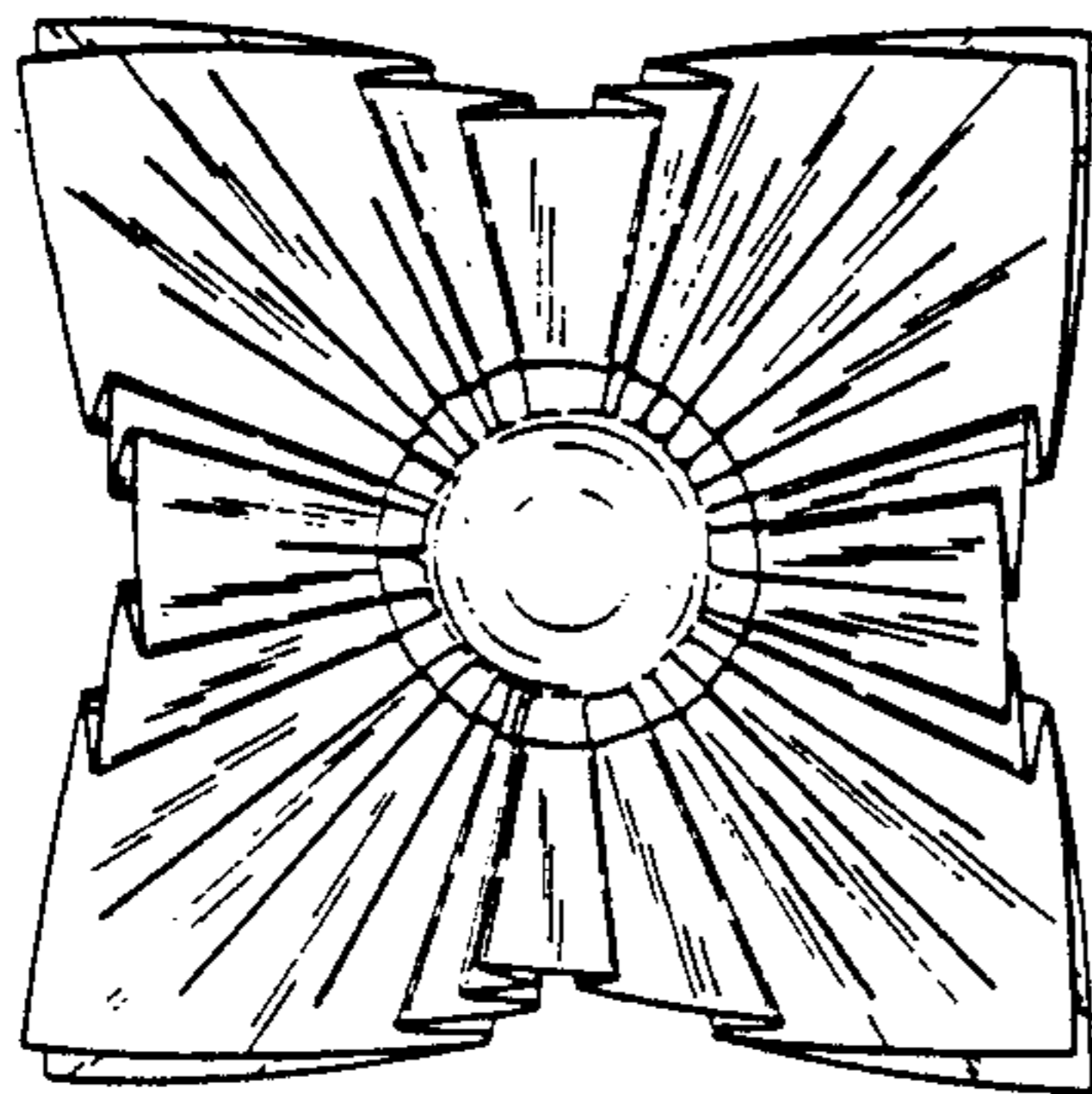

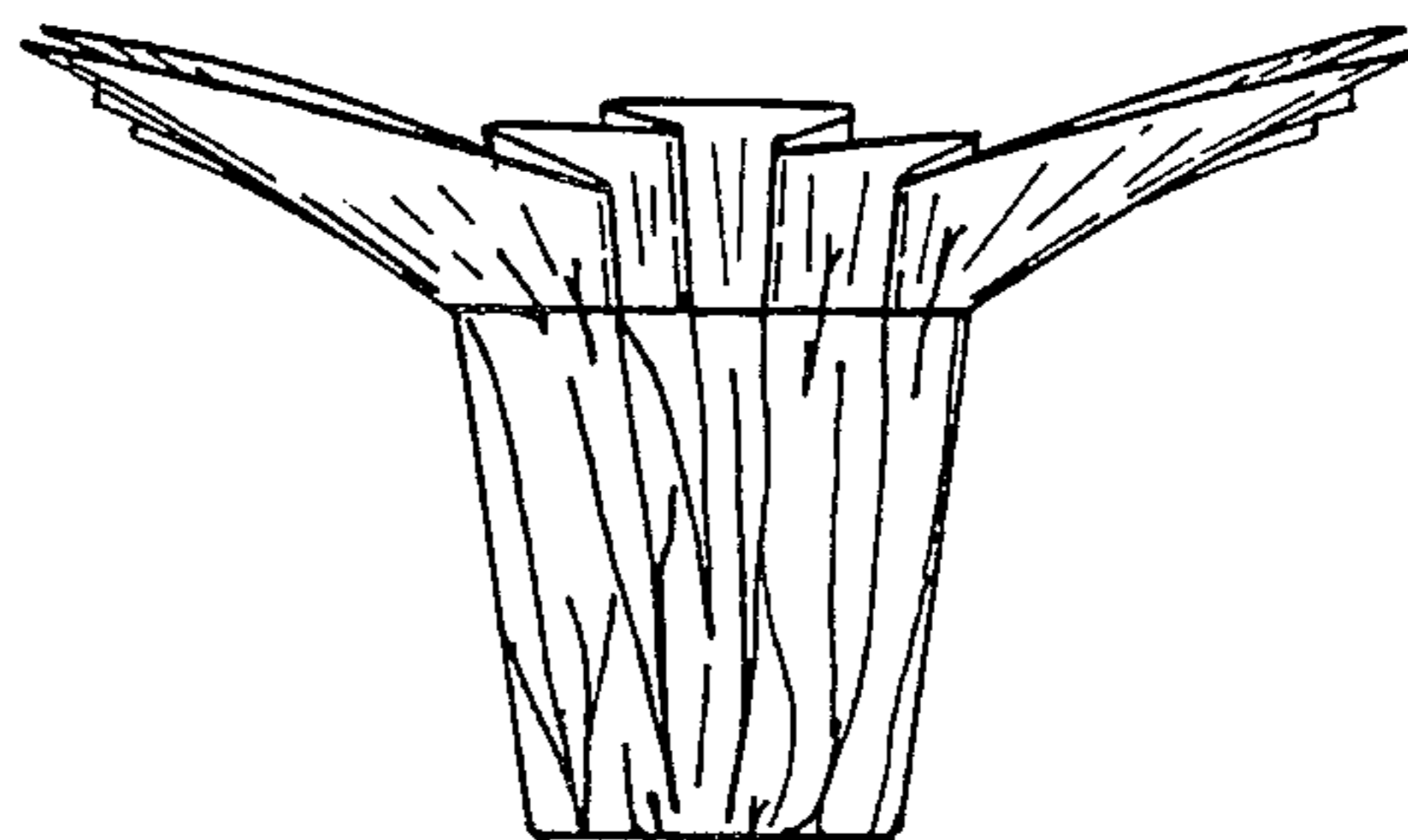
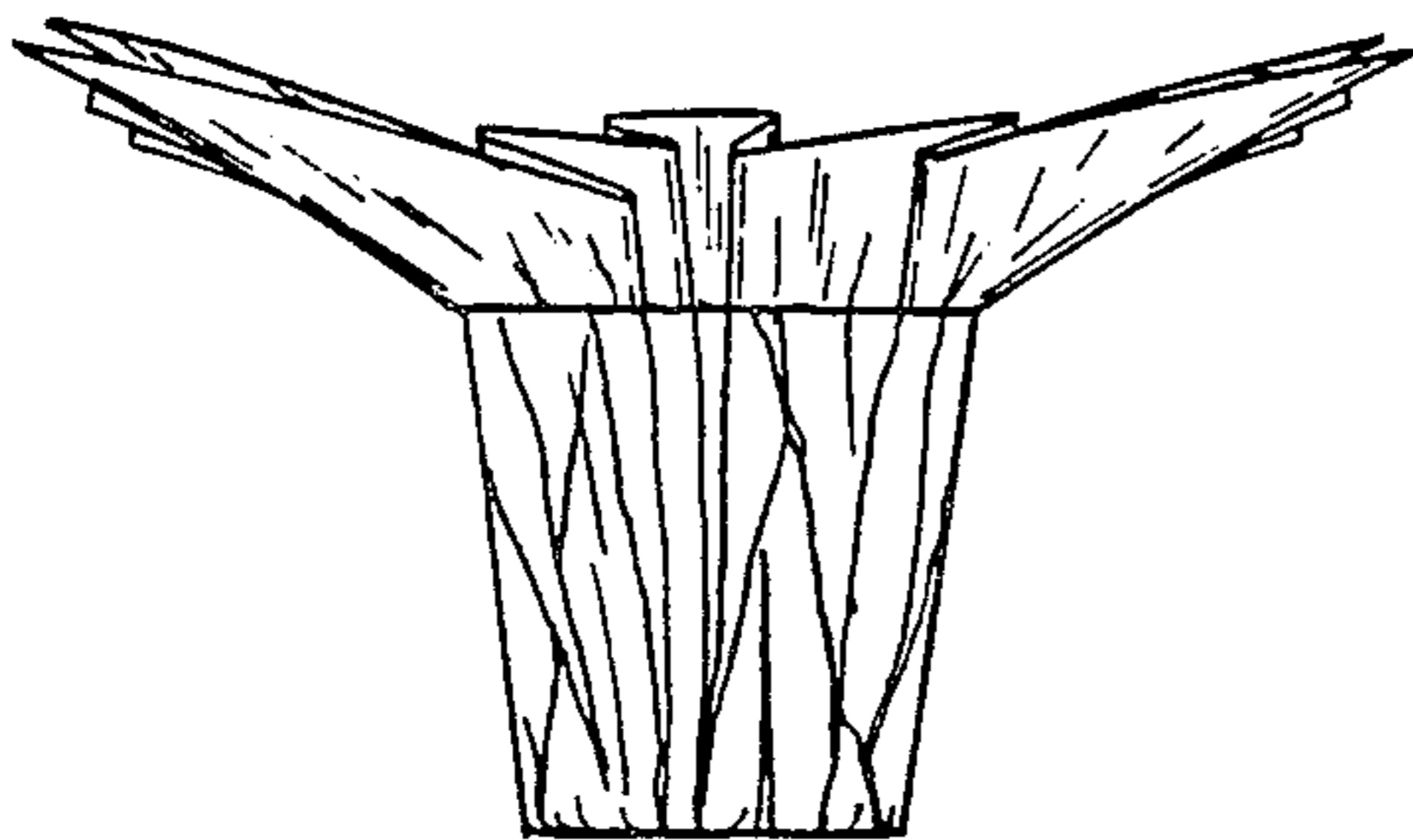
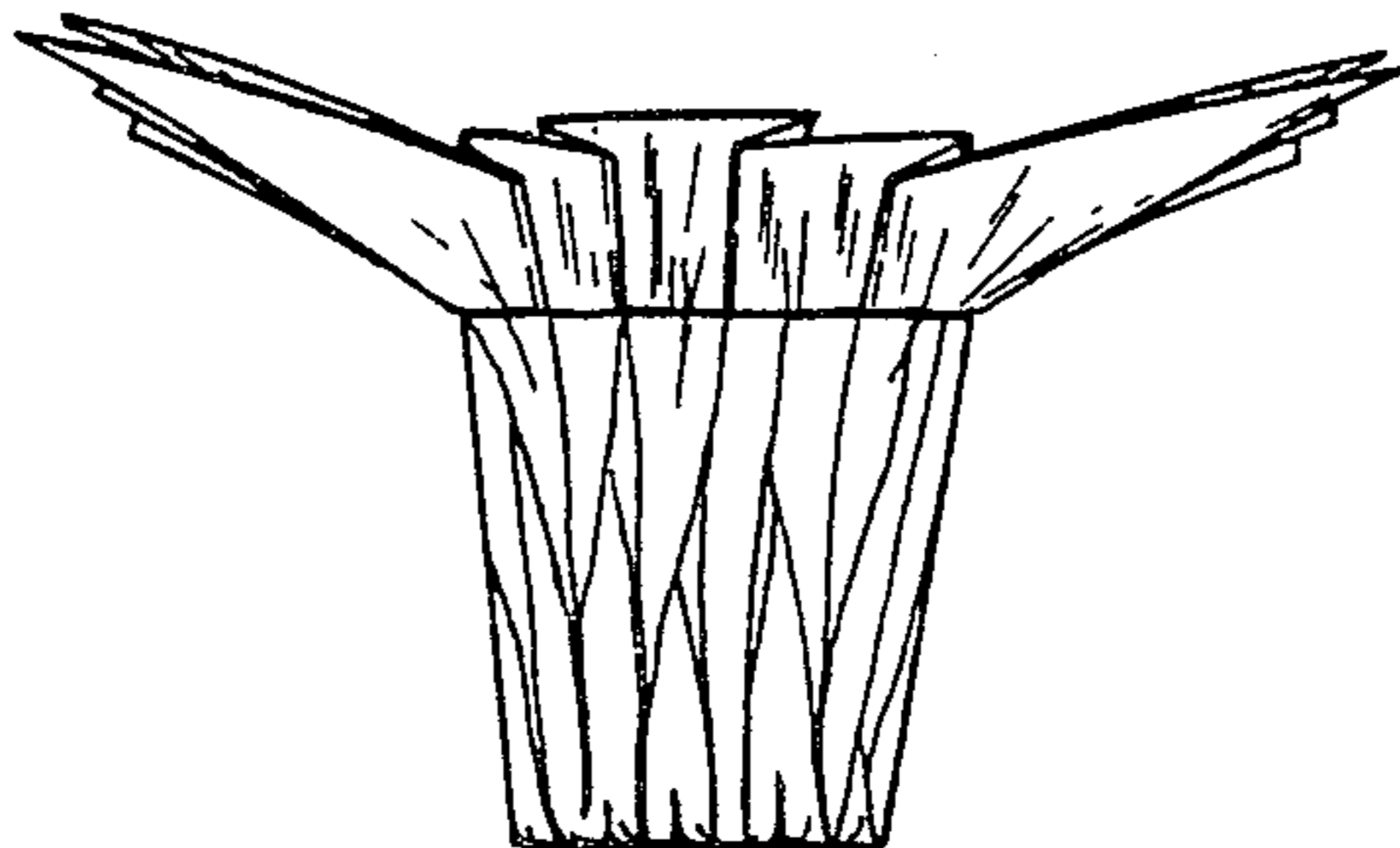
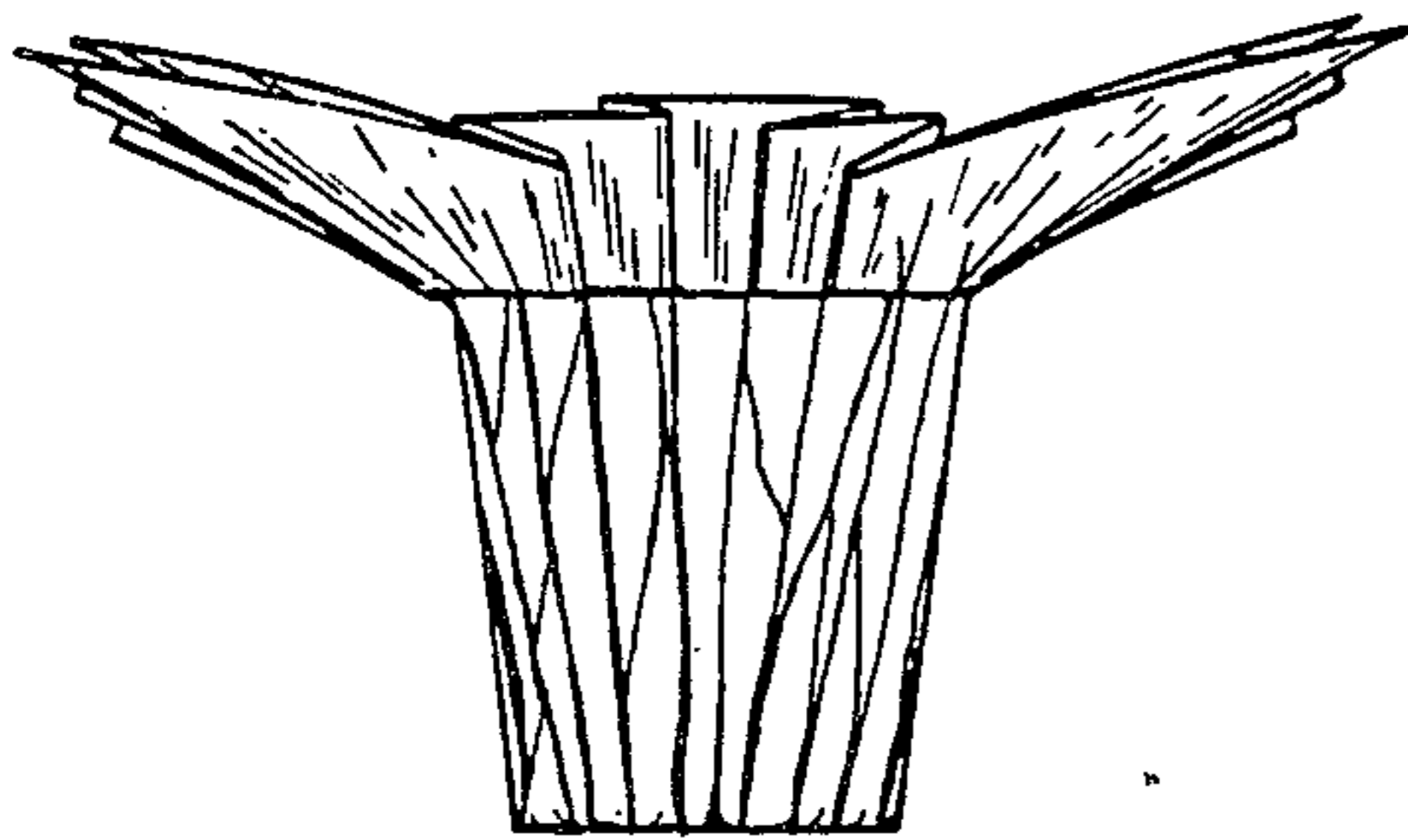
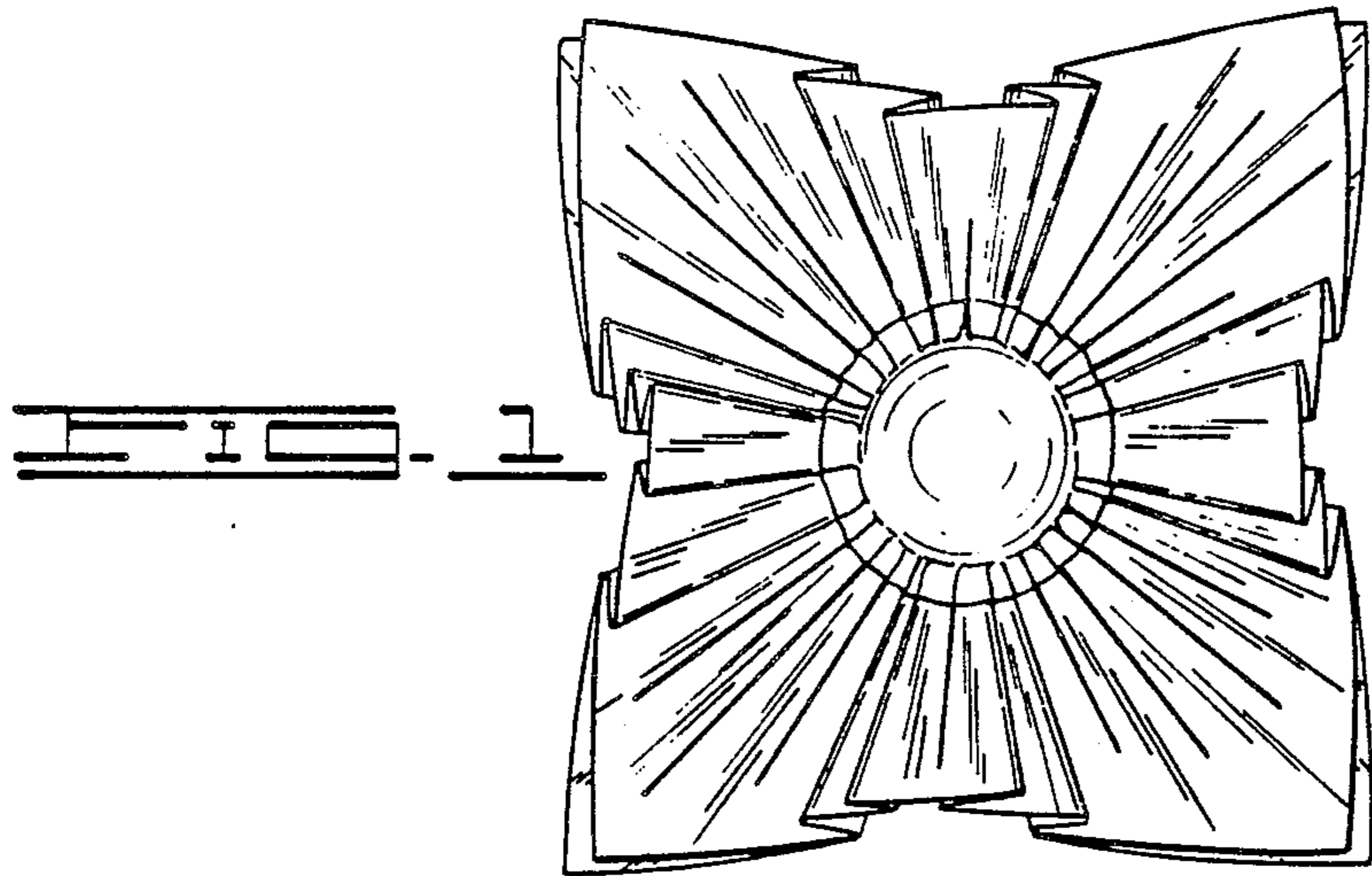

FIG. 4

FIG. 5

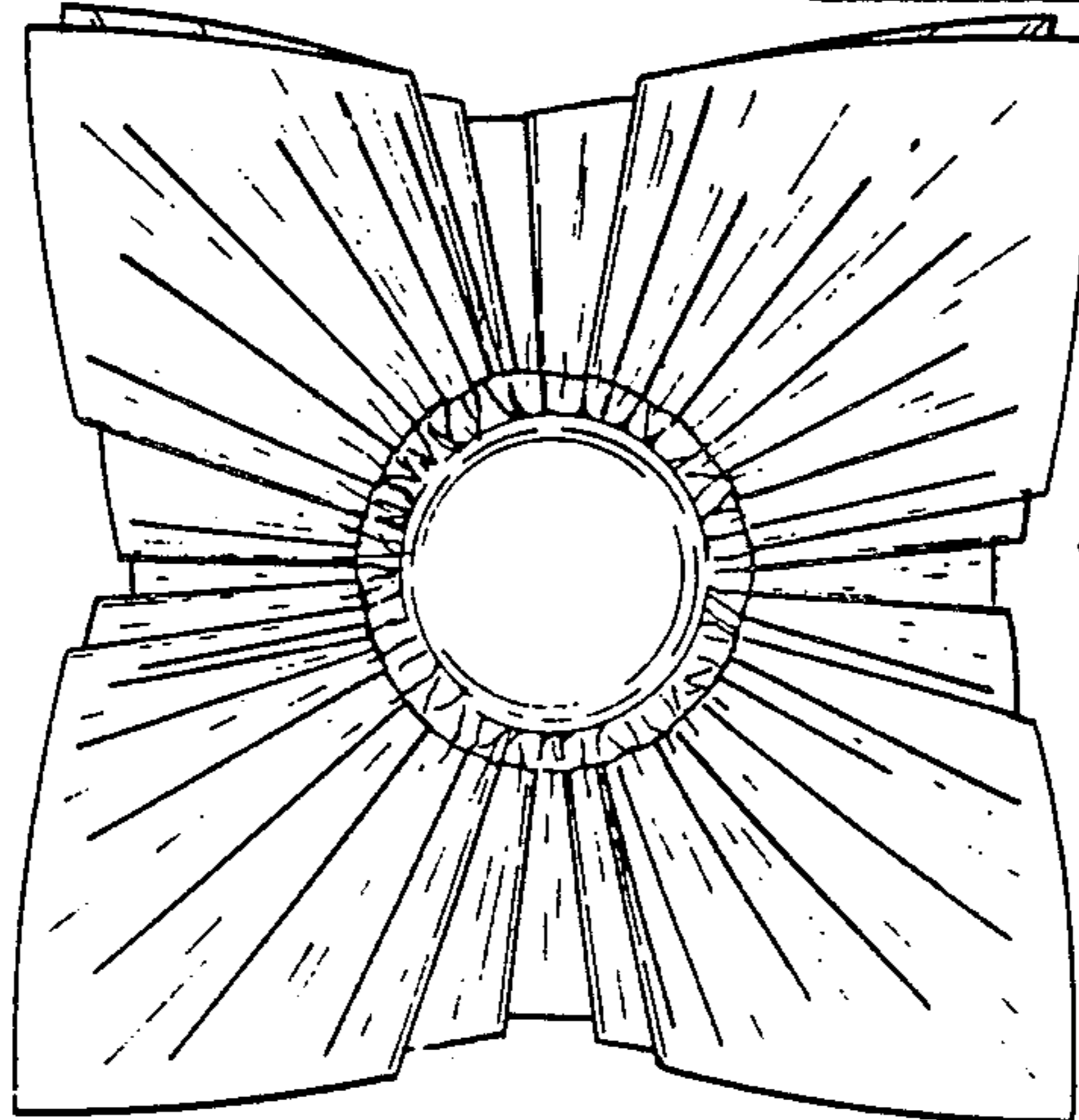

FIG. 6