

United States Patent [19]
Beeren

[11] **Patent Number: Des. 293,140**
[45] **Date of Patent: ** Dec. 8, 1987**

[54] **VACUUM CLEANER**
[75] **Inventor: Aloysius J. M. Beeren, Haren, Netherlands**
[73] **Assignee: U.S. Philips Corporation, New York, N.Y.**
[**] **Term: 14 Years**
[21] **Appl. No.: 753,204**
[22] **Filed: Jul. 9, 1985**

[30] **Foreign Application Priority Data**
Jan. 22, 1985 [DE] Fed. Rep. of Germany MR16002
[52] **U.S. Cl. D32/18**
[58] **Field of Search D32/17, 18; 15/344**

[56] **References Cited**
U.S. PATENT DOCUMENTS
D. 257,661 12/1980 Gantz D32/18

D. 278,278 4/1985 McCloskey D32/18
D. 280,453 9/1985 Tsuji D32/18
D. 284,797 7/1986 Fujii et al. D32/18

Primary Examiner—Wallace R. Burke
Assistant Examiner—Ruth Takemoto
Attorney, Agent, or Firm—Thomas A. Briody; William J. Streeter; Rolf E. Schneider

[57] **CLAIM**

The ornamental design for a vacuum cleaner, as shown.

DESCRIPTION

FIG. 1 is a front, top and right side perspective view of a vacuum cleaner showing my new design;
FIG. 2 is a right side elevational view thereof;
FIG. 3 is a left side elevational view thereof;
FIG. 4 is a top plan view thereof;
FIG. 5 is a bottom plan view thereof;
FIG. 6 is a front elevational view thereof; and
FIG. 7 is a rear elevational view thereof.

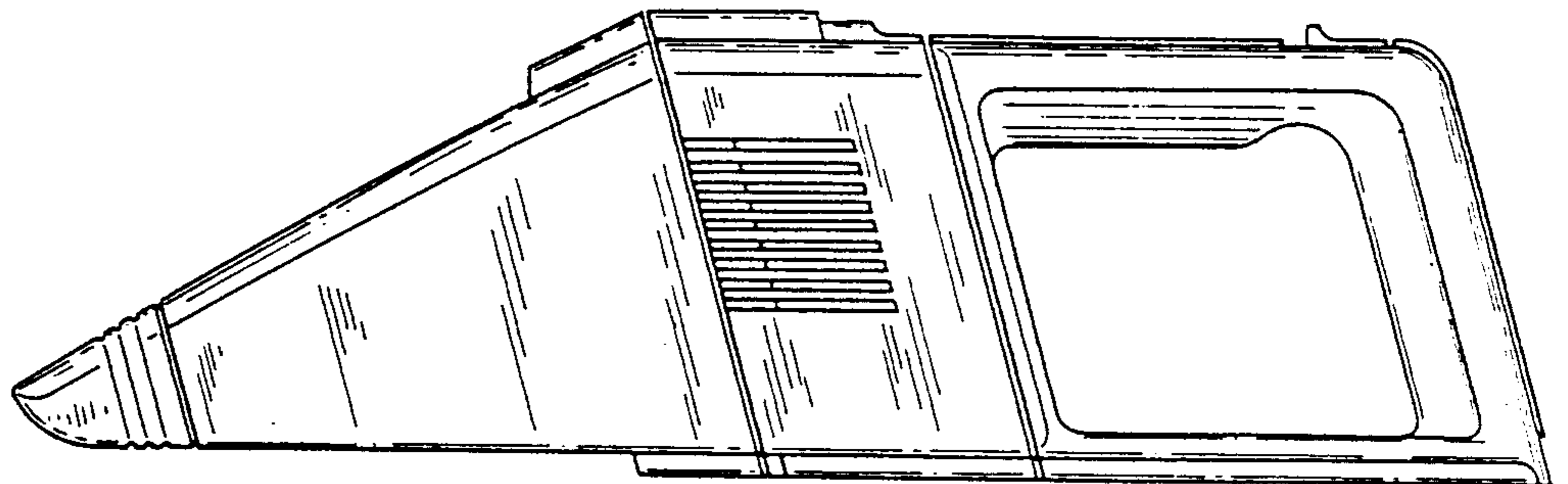
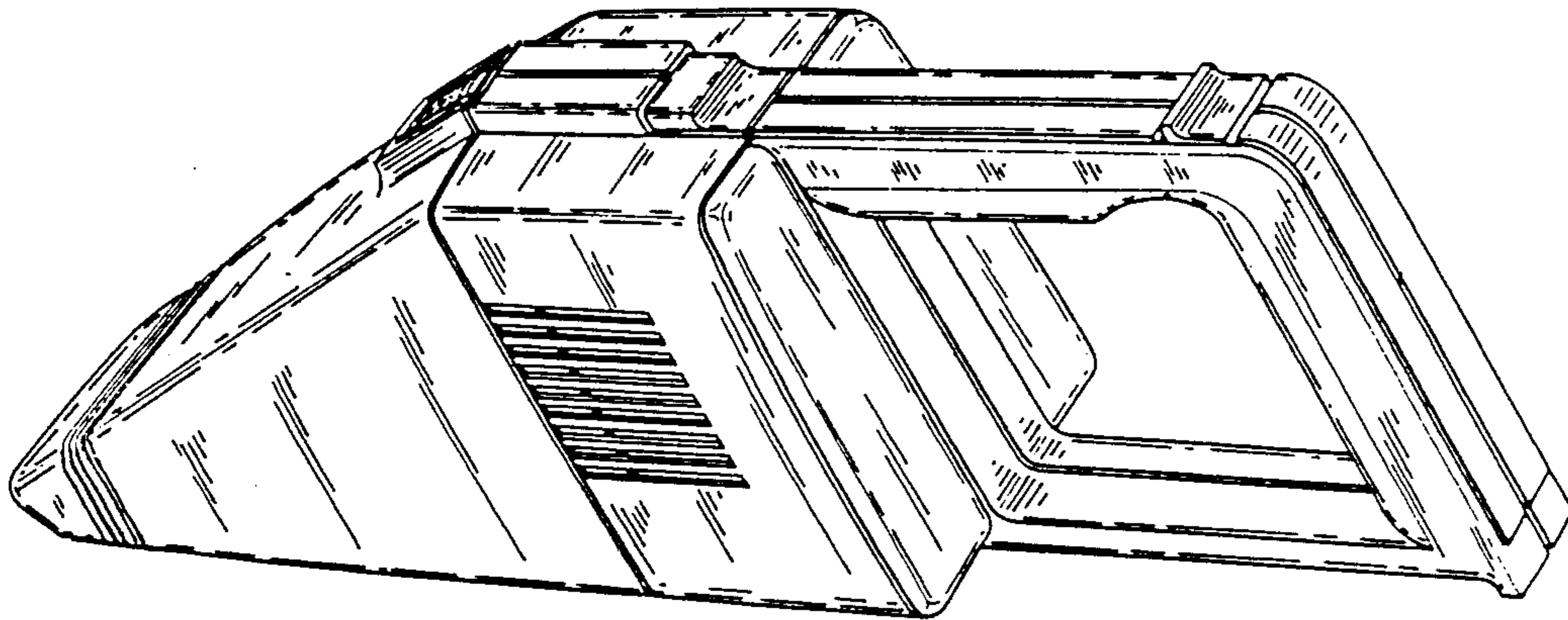

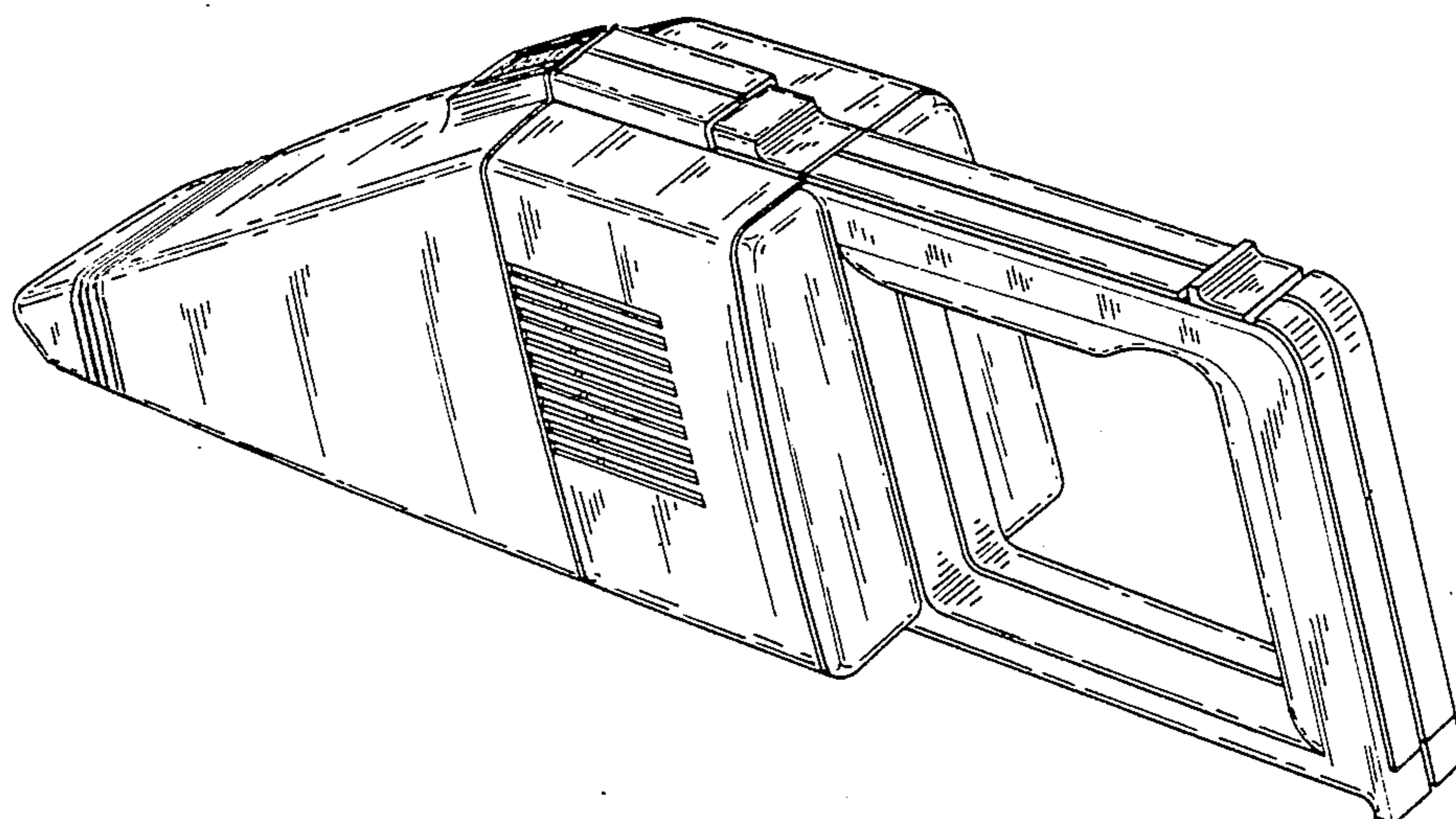

FIG. 1

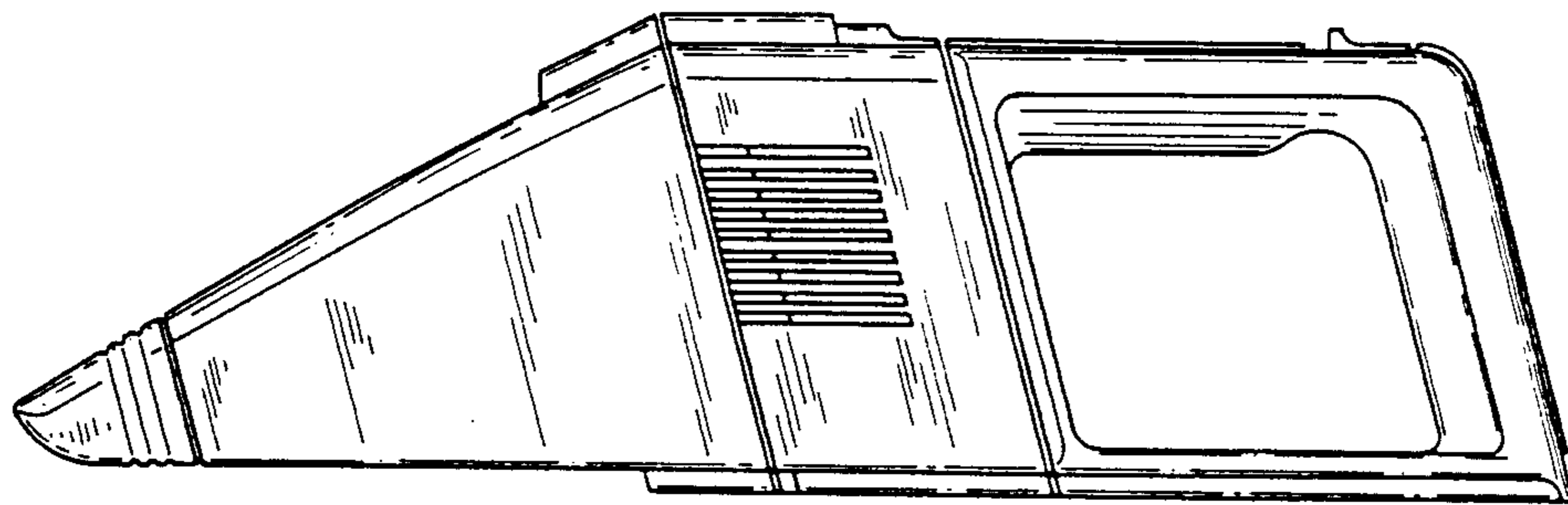

FIG. 2

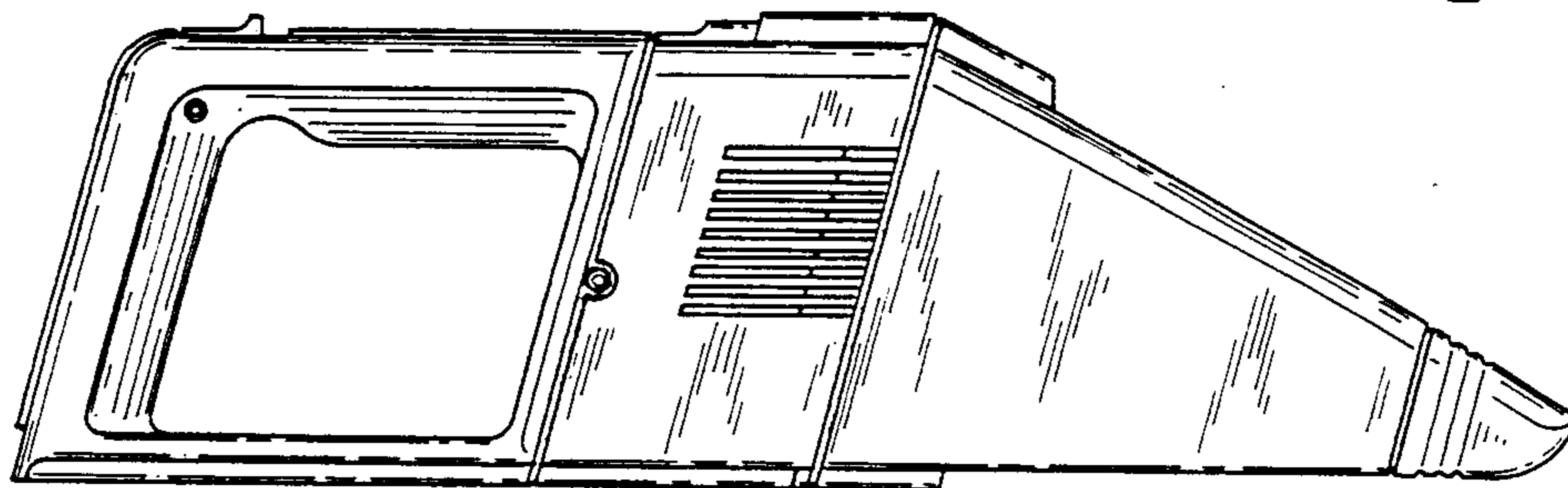

FIG. 3

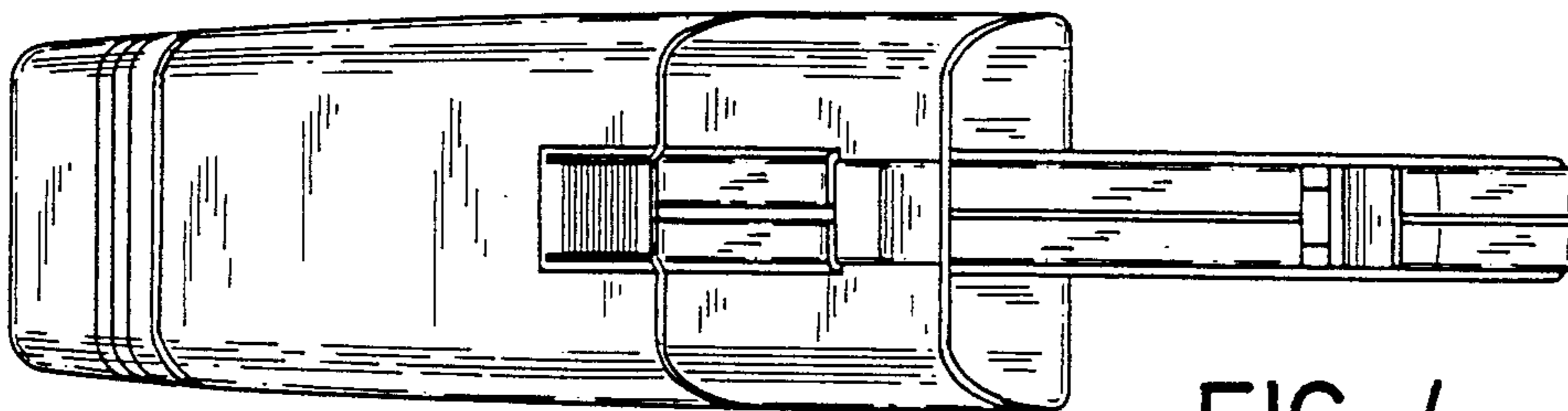

FIG. 4

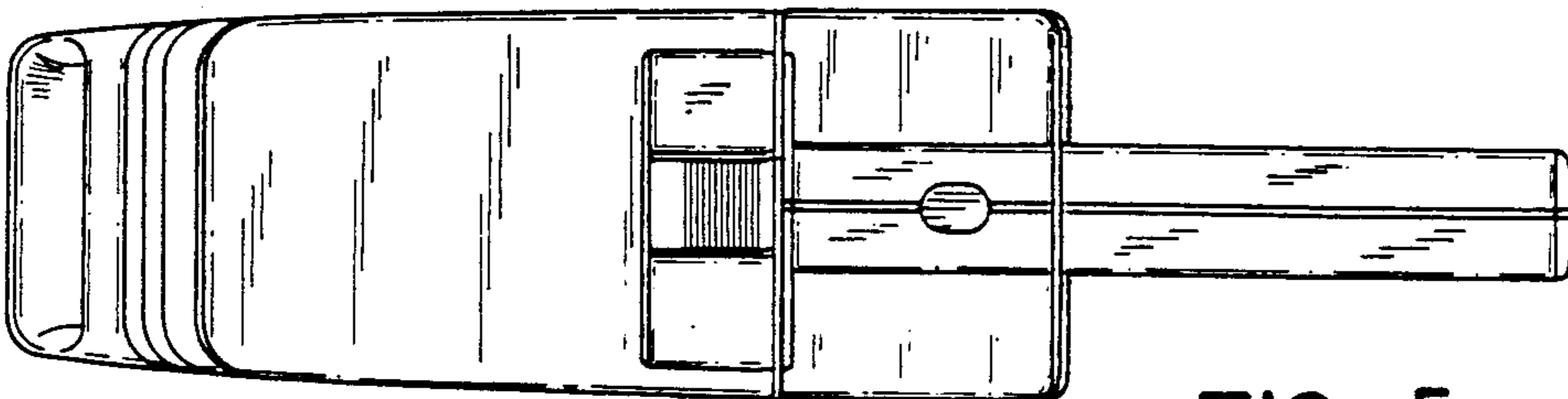

FIG. 5

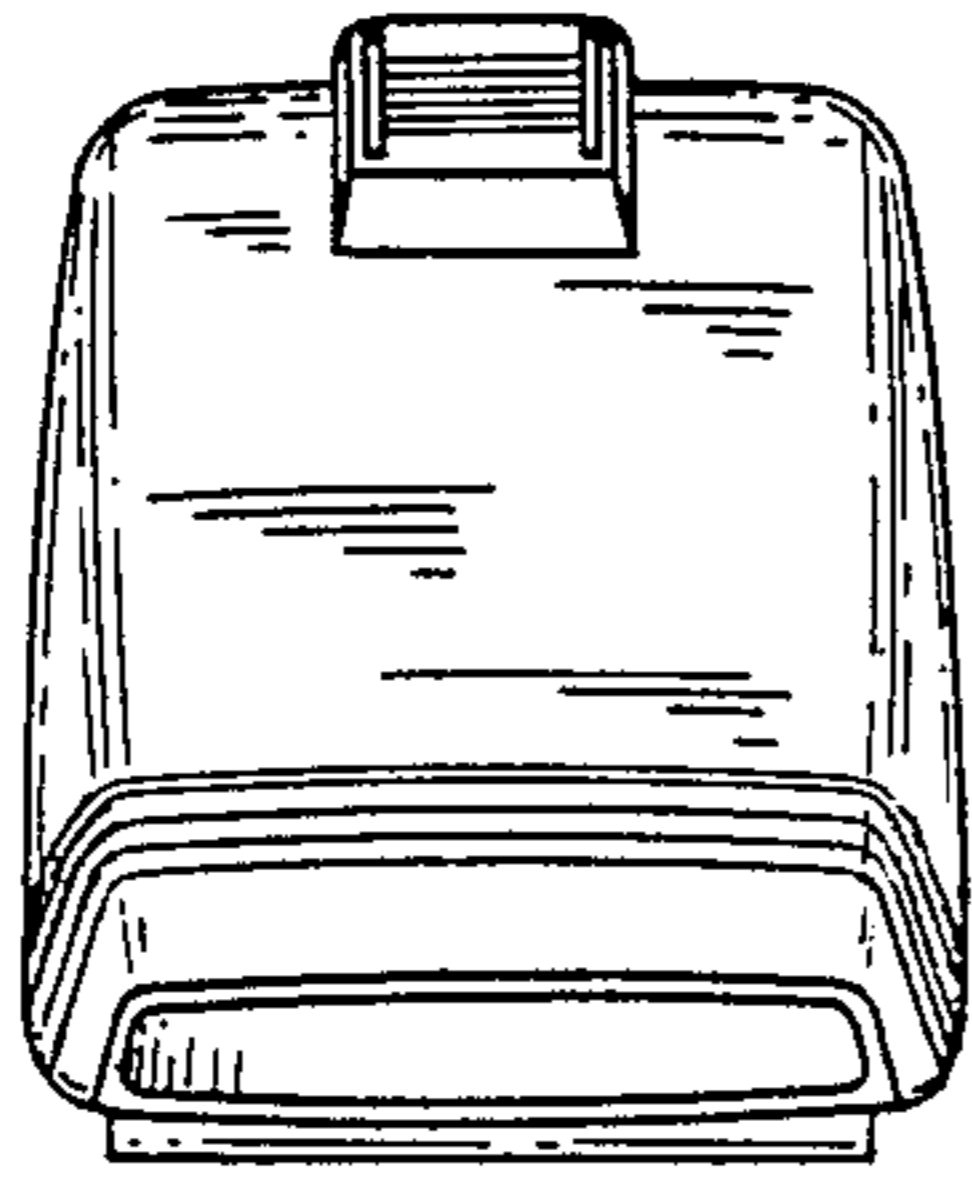

FIG. 6

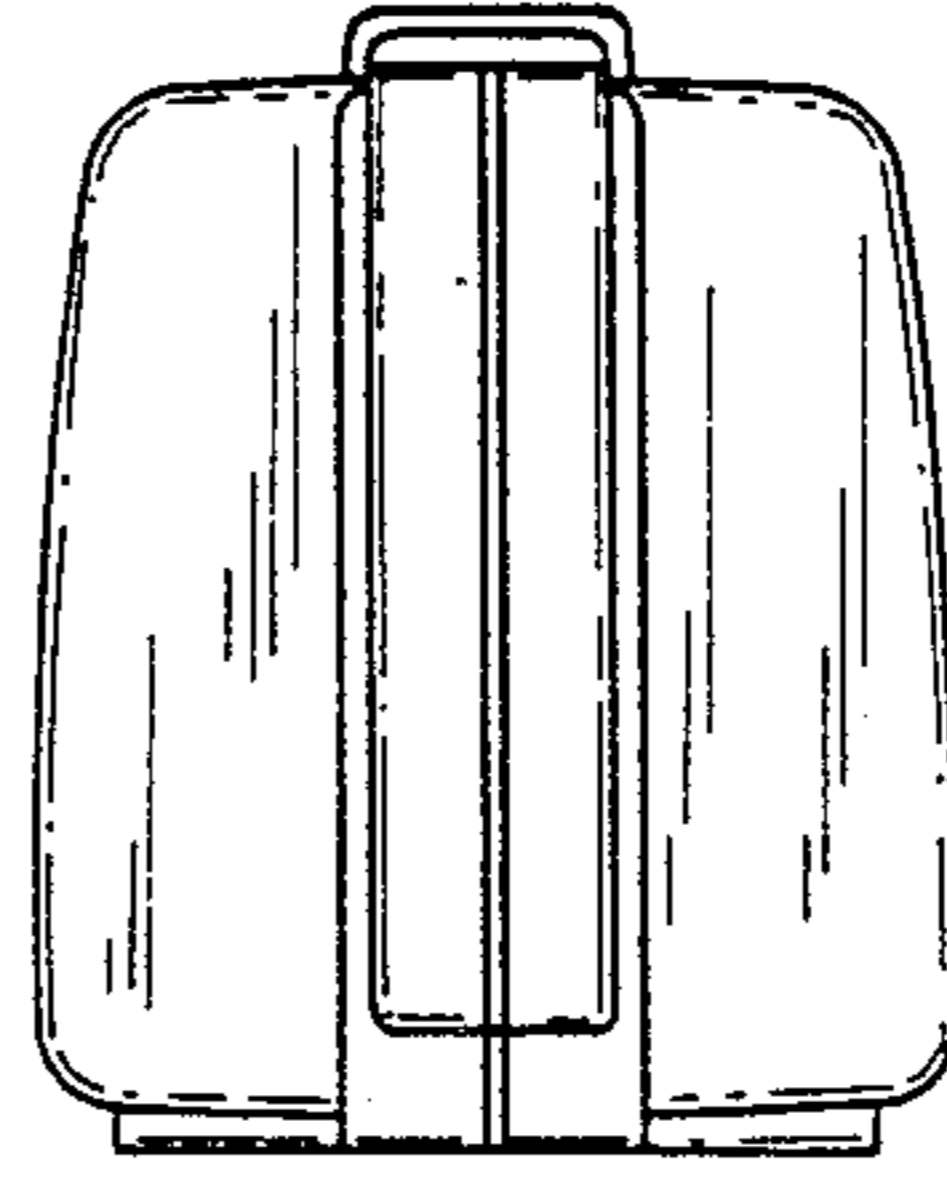

FIG. 7