

[54] PORTABLE READING LAMP

[75] Inventor: Haim Shwisha, Westport, Conn.

[73] Assignee: Electrix, Inc., New Haven, Conn.

[**] Term: 14 Years

[21] Appl. No.: 749,526

[22] Filed: Jun. 27, 1985

[52] U.S. Cl. D26/60

[58] Field of Search D26/60-66,
D26/37-50; 362/418, 427, 269, 275, 396, 103,
108, 127, 130, 131

[56] References Cited

U.S. PATENT DOCUMENTS

D. 60,875	4/1922	Nelson	D26/61
D. 158,208	4/1950	Lundquist	D26/63
D. 213,902	4/1969	Muller	D26/64
2,358,422	9/1944	Springer	362/396 X
2,506,685	5/1950	Sadloski et al.	362/108
3,388,246	6/1968	Bailey	D26/64 X

OTHER PUBLICATIONS

Home Lighting & Accessories, 5-1983, p. 40, Fuco Light Clip On-Lamp (top left).

Primary Examiner—Susan J. Lucas
Attorney, Agent, or Firm—Bachman & LaPointe

[57] CLAIM

The ornamental design for a portable reading lamp, as shown and described.

DESCRIPTION

FIG. 1 is a top, front perspective view of a portable reading lamp showing my new design, the chair being shown in broken lines for illustrative purposes only; FIG. 2 is a fragmentary front elevational view thereof on an enlarged scale; FIG. 3 is a fragmentary left side elevational view thereof on an enlarged scale; FIG. 4 is a top plan view thereof on an enlarged scale; FIG. 5 is a right side elevational view thereof on an enlarged scale; FIG. 6 is a bottom plan view thereof on an enlarged scale. The strap is fragmentarily shown in FIGS. 2 and 3 for convenience of illustration.

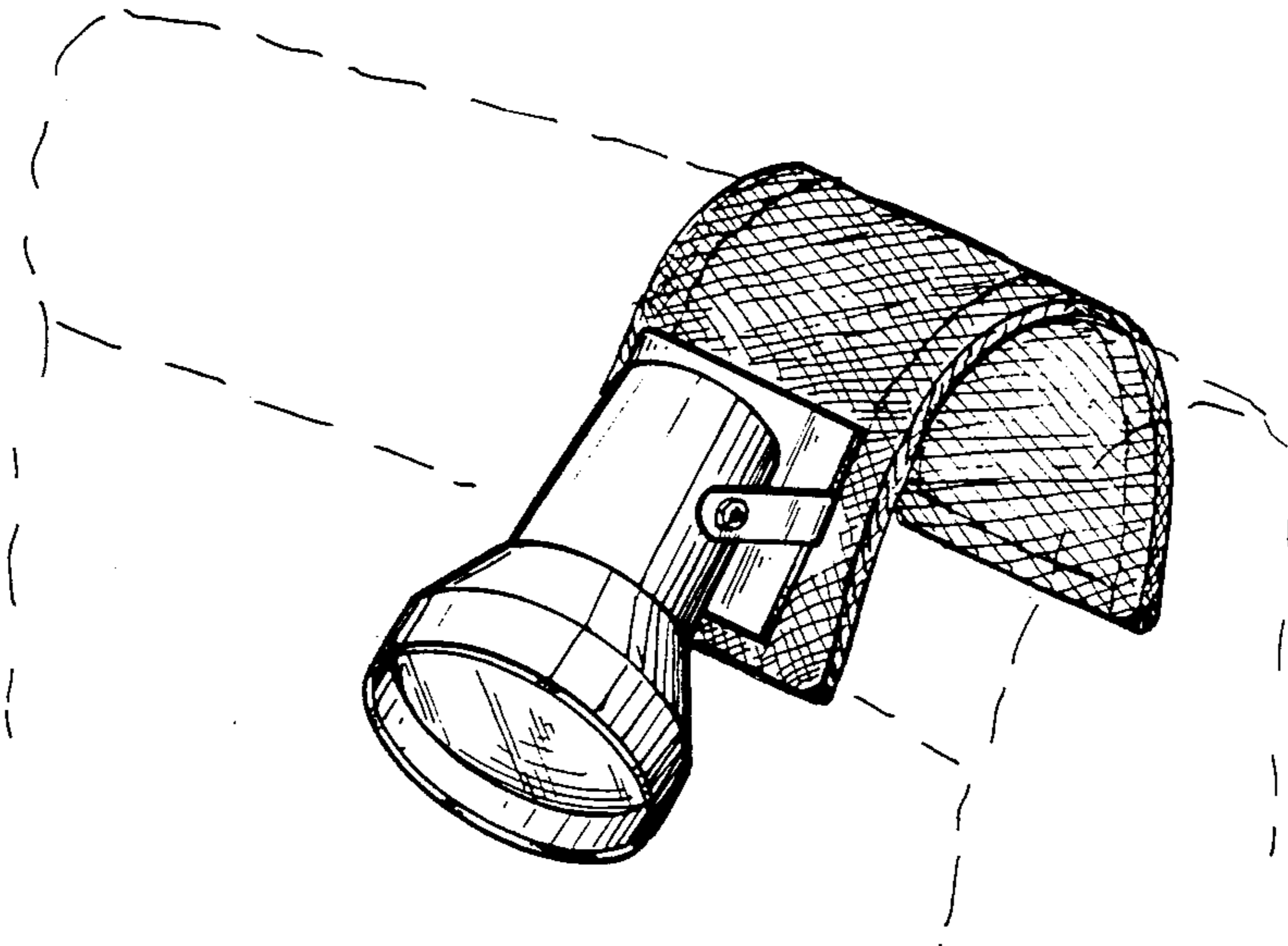

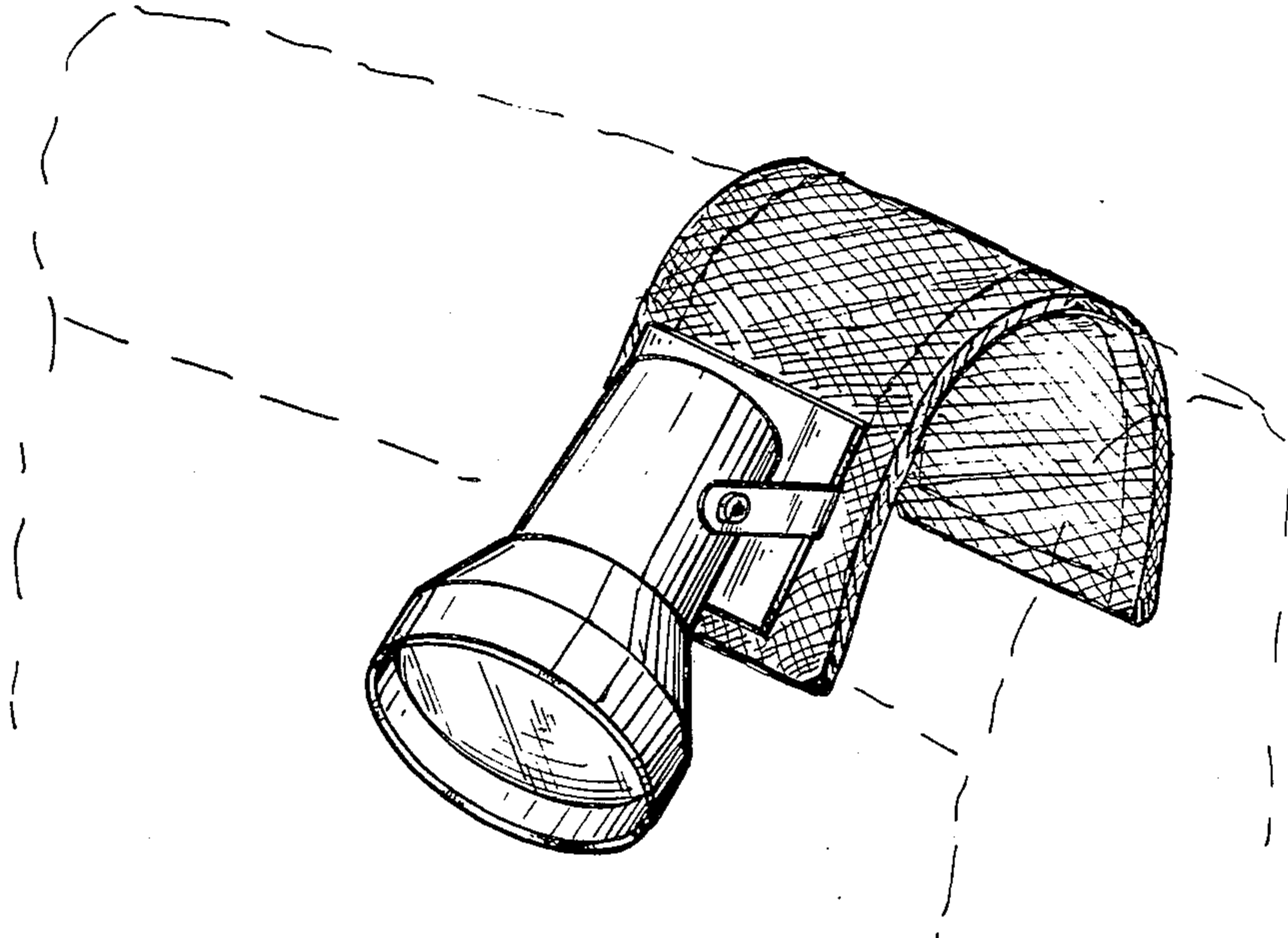

FIG-1

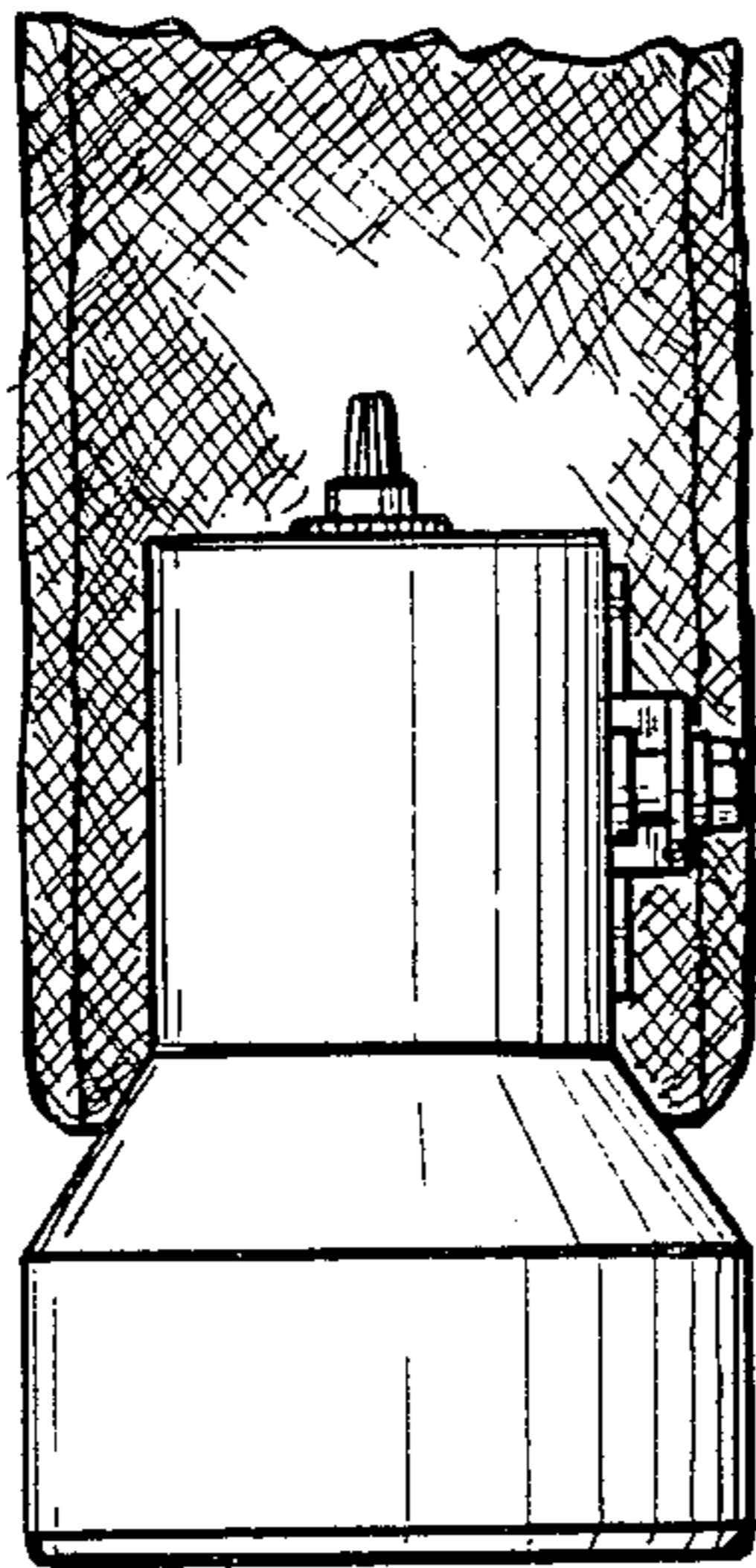

FIG-2

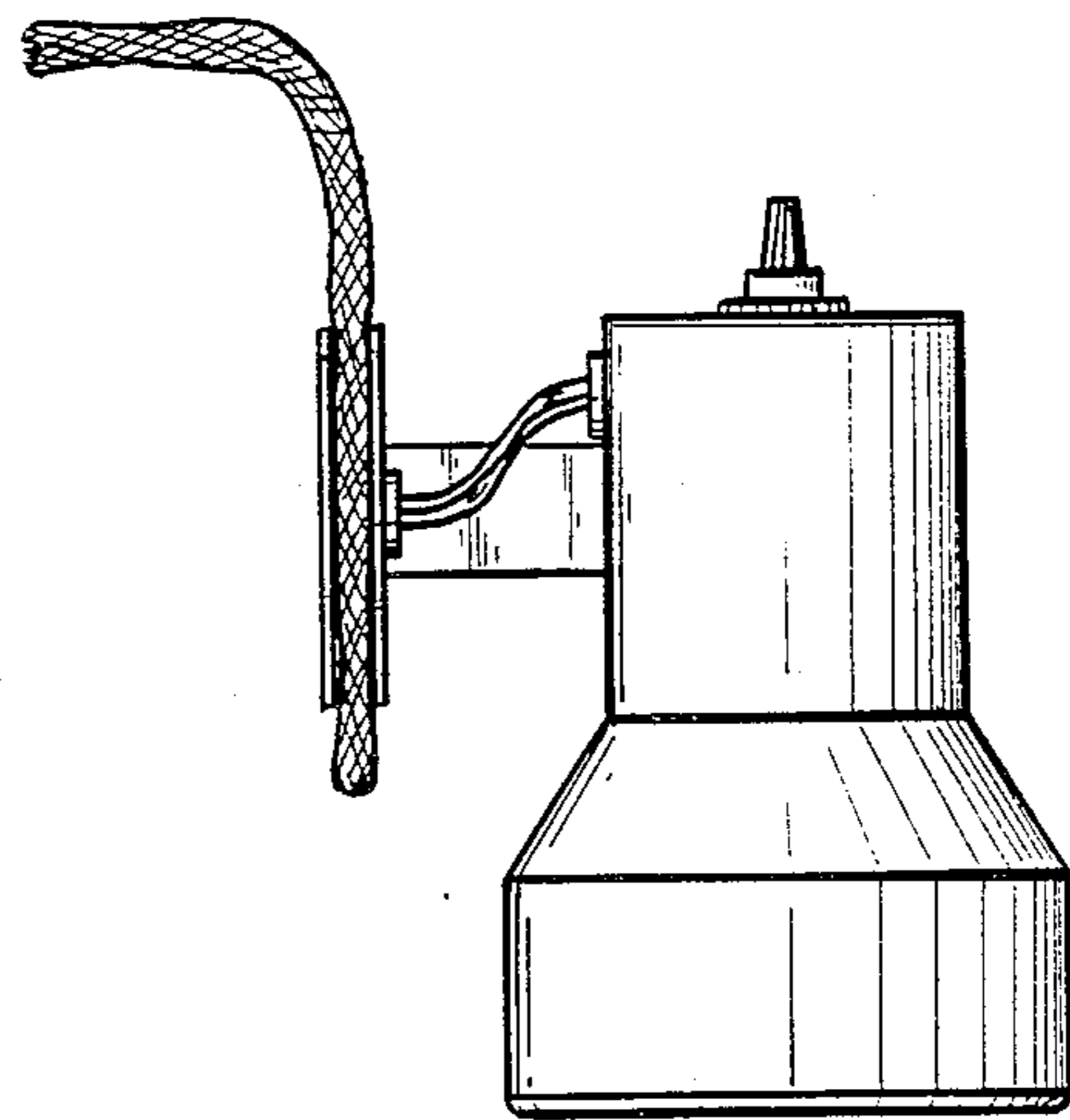

FIG-3

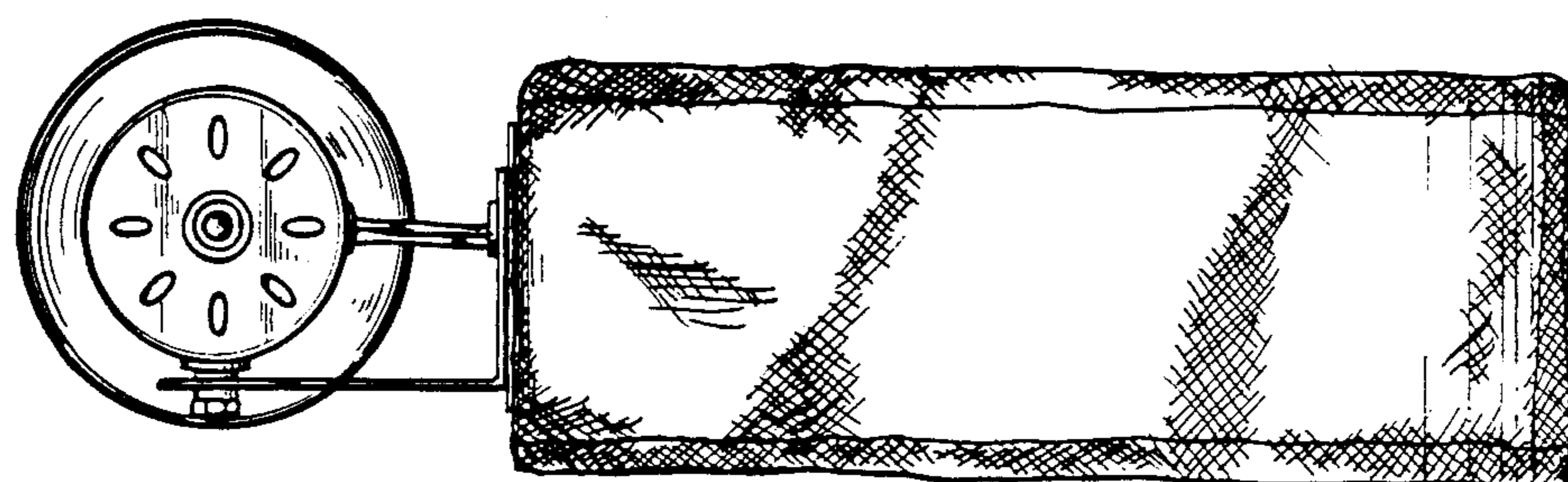

FIG-4

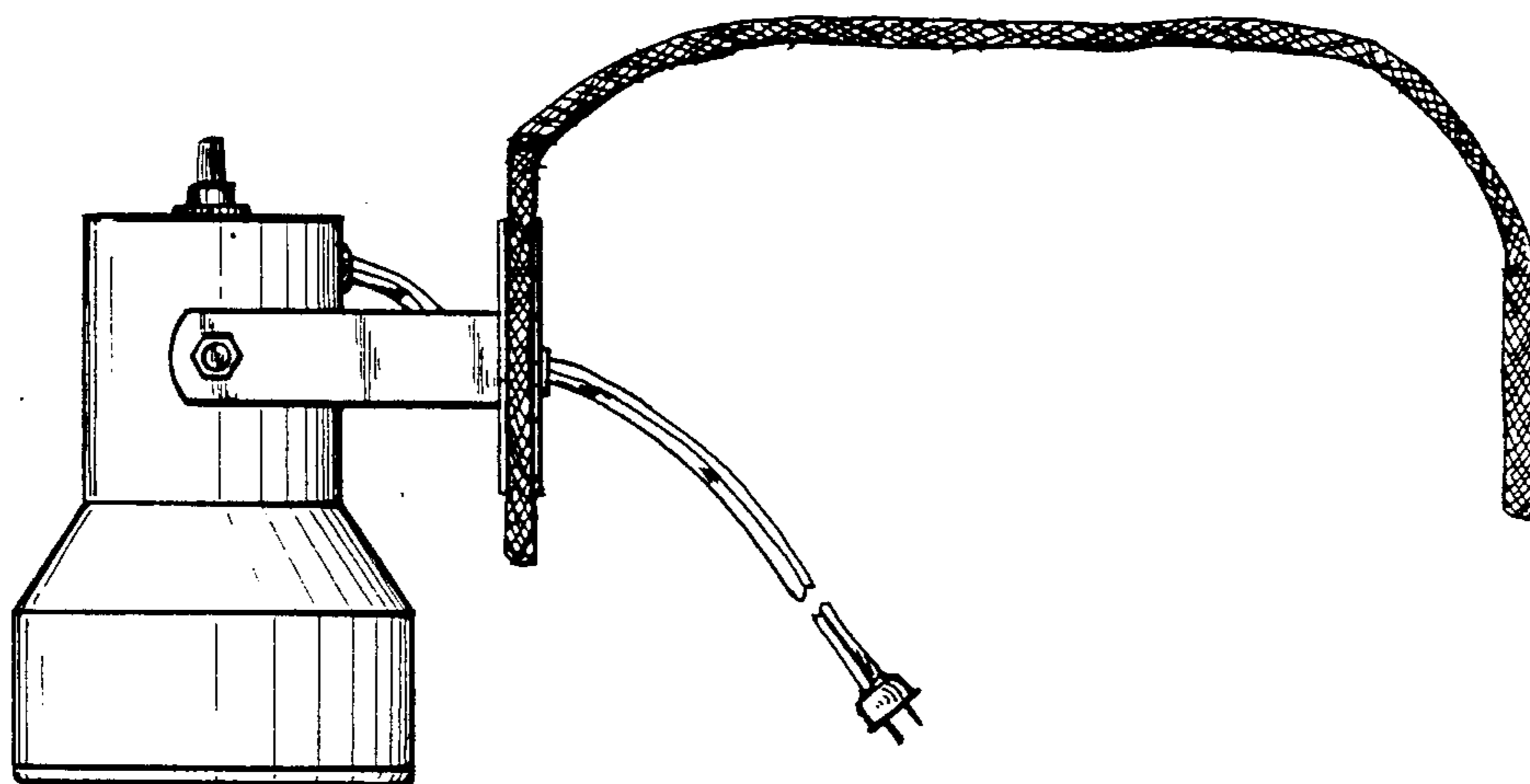

FIG-5

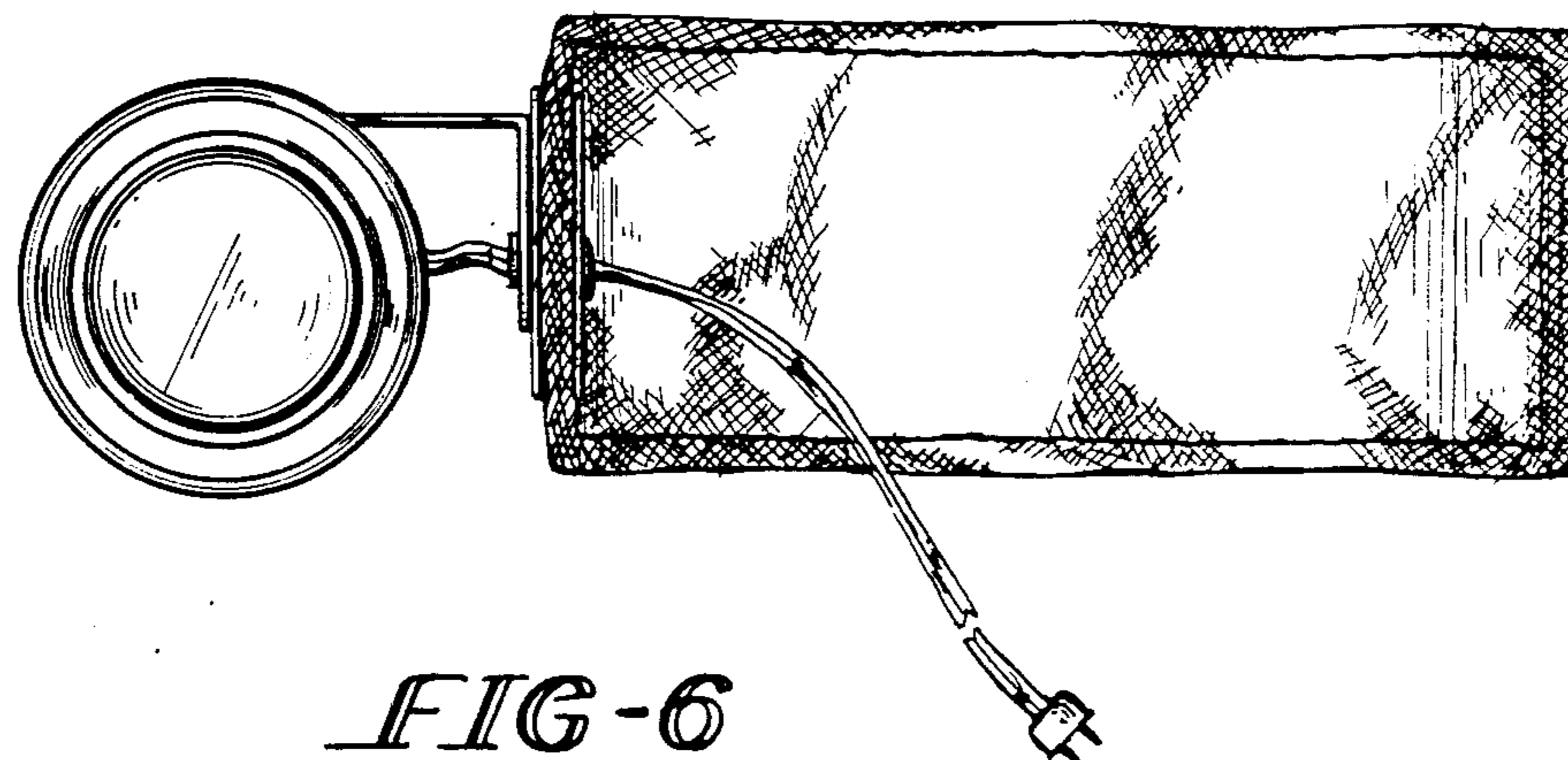

FIG-6