

United States Patent [19]

Adler

[11] Patent Number: **Des. 292,991**

[45] Date of Patent: **** Dec. 1, 1987**

[54] **DESK CADDY**

[75] Inventor: **Herbert Adler, Nassau County, N.Y.**

[73] Assignee: **Crest Industries Corp., Deer Park, N.Y.**

[**] Term: **14 Years**

[21] Appl. No.: **899,500**

[22] Filed: **Aug. 22, 1986**

[52] U.S. Cl. **D19/78; D3/66; D7/5; D9/307; D19/82; D19/97**

[58] Field of Search **D19/20-25, D19/75, 77-85, 97; D7/5; D9/307; 211/69.5; 206/314, 372; D3/44, 66**

[56] **References Cited**

U.S. PATENT DOCUMENTS

D. 140,334	2/1945	Blecher	D7/5
D. 153,602	5/1949	Halbriter	D7/5
D. 155,152	9/1949	Greenstein et al.	D7/5
D. 208,314	8/1967	Guerrero	D7/5
D. 231,637	5/1974	Stahel	D19/78
D. 234,510	3/1975	Mori	D19/78
D. 266,435	10/1982	Laughlin	D19/78

D. 283,009	3/1986	Jennette	D9/307
3,624,939	12/1971	Gossard	D9/307

OTHER PUBLICATIONS

Foster House cat. Xmas 1976, p. 57, item X07617p.
Park Sherman cat., 1979-1980, p. 4, item No. 1326.
Park Sherman cat., 1979-1980, p. 4, item No. 1333.

Primary Examiner—George P. Word
Attorney, Agent, or Firm—Howard C. Miskin

[57] **CLAIM**

The ornamental design for a desk caddy, as shown and described.

DESCRIPTION

FIG. 1 is a front elevational of a desk caddy showing my new design;

FIG. 2 is a rear elevational view thereof;

FIG. 3 is a right side elevational view thereof;

FIG. 4 is a left side elevational view thereof;

FIG. 5 is a top plan view thereof; and

FIG. 6 is a bottom plan view thereof.

The environmental structure shown in dotted lines in FIGS. 1-3 is for illustrative purposes only and not a part of the design claimed.

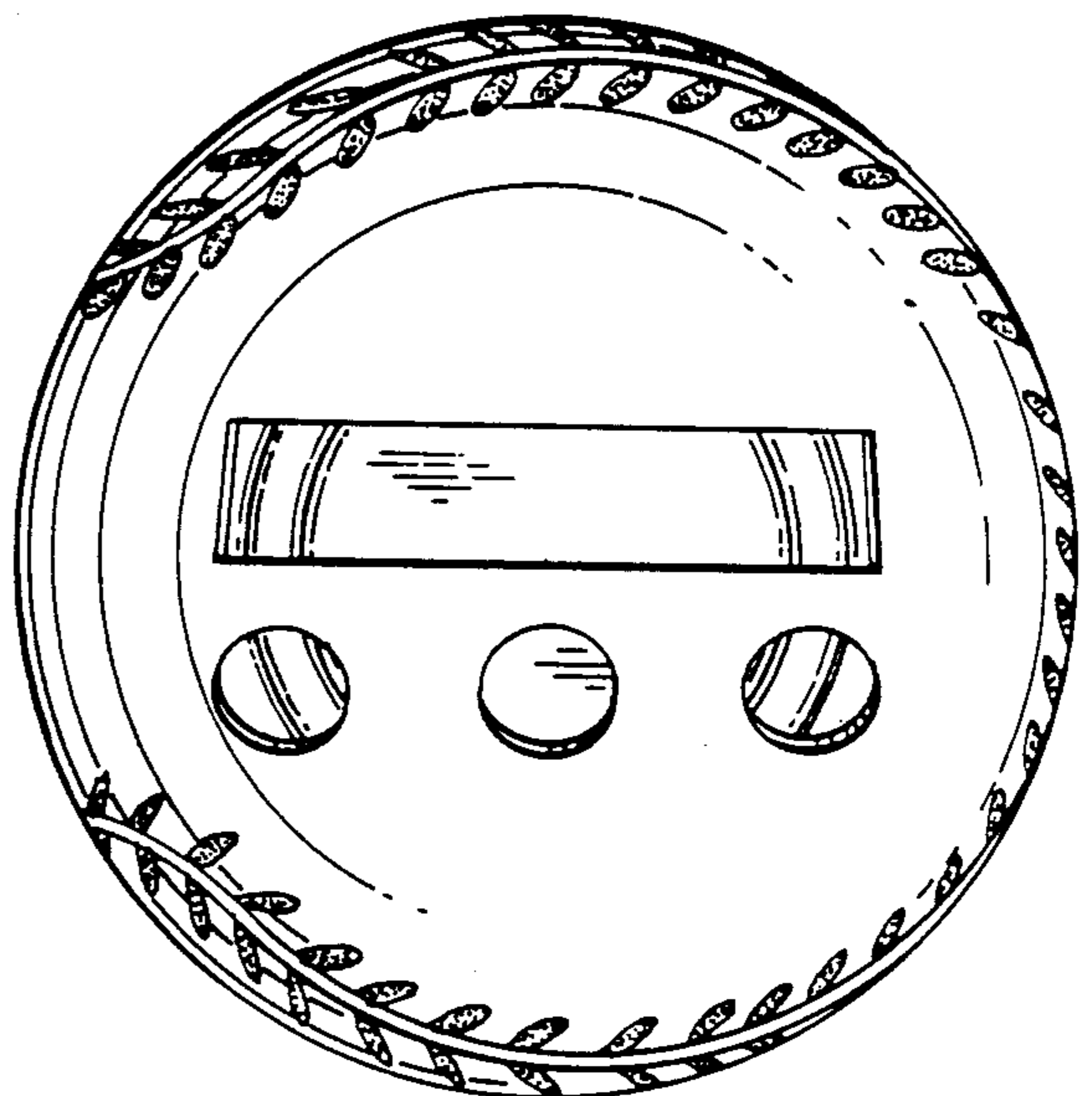
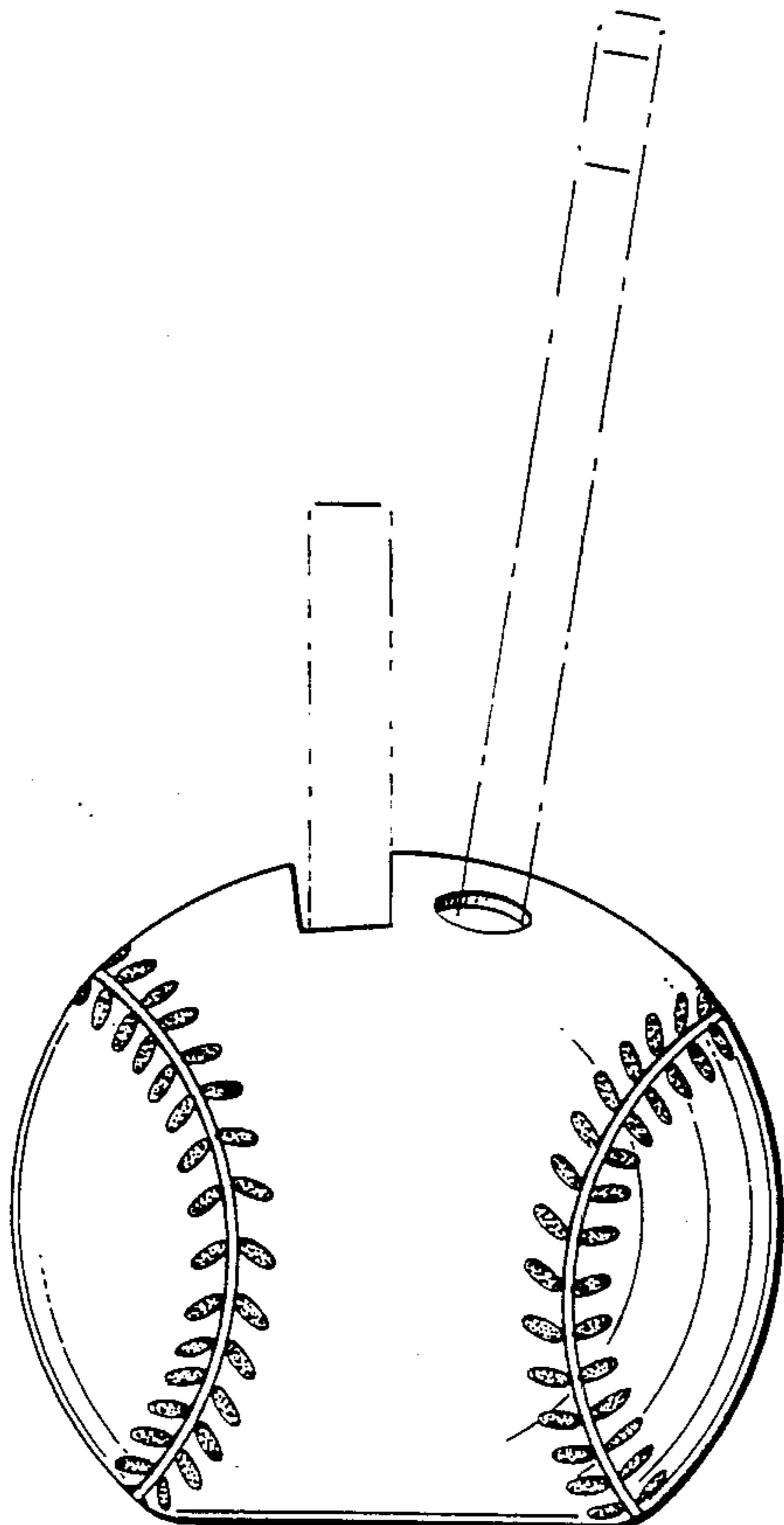

FIG. 1

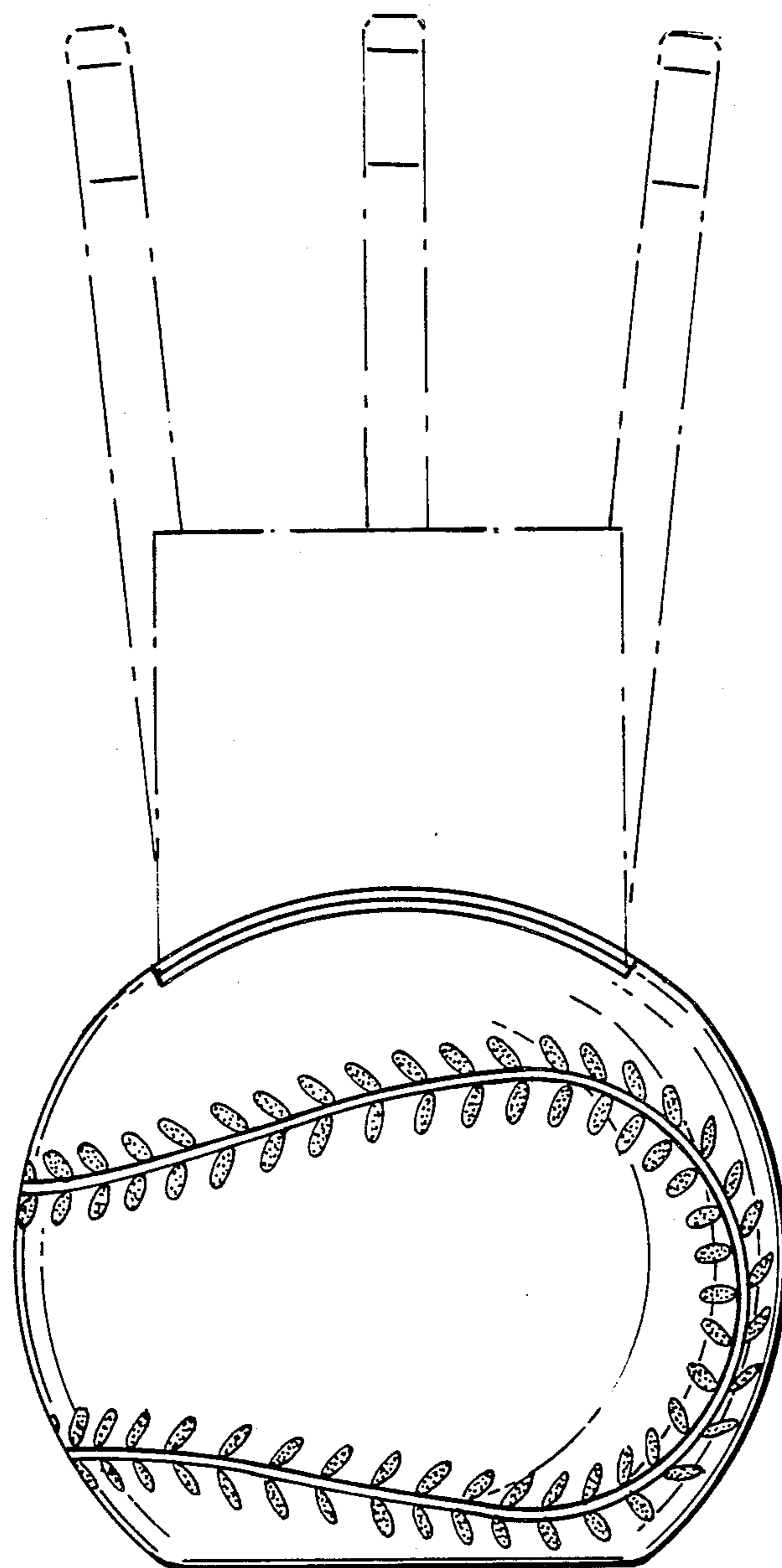

FIG. 2

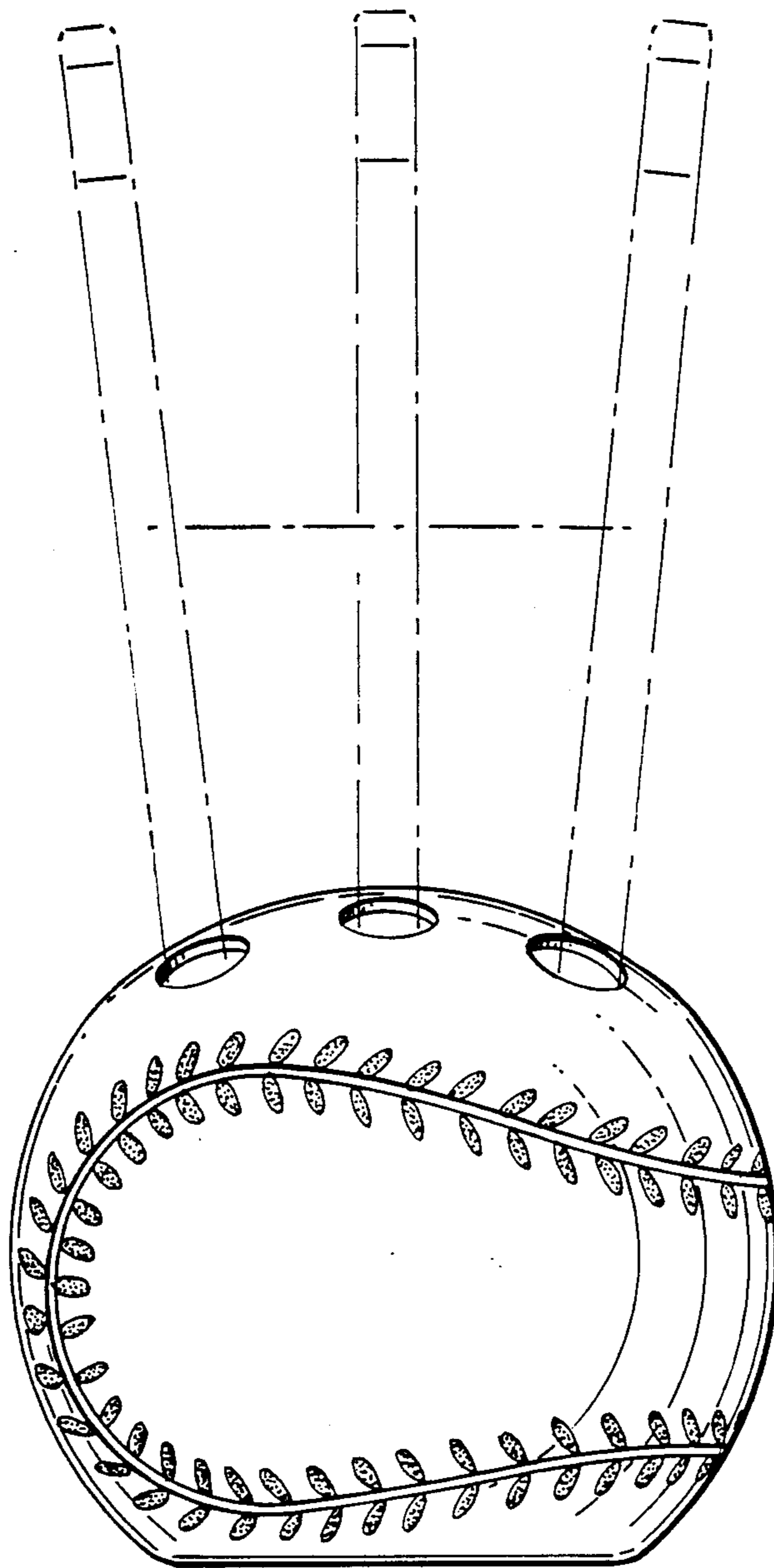

FIG. 3

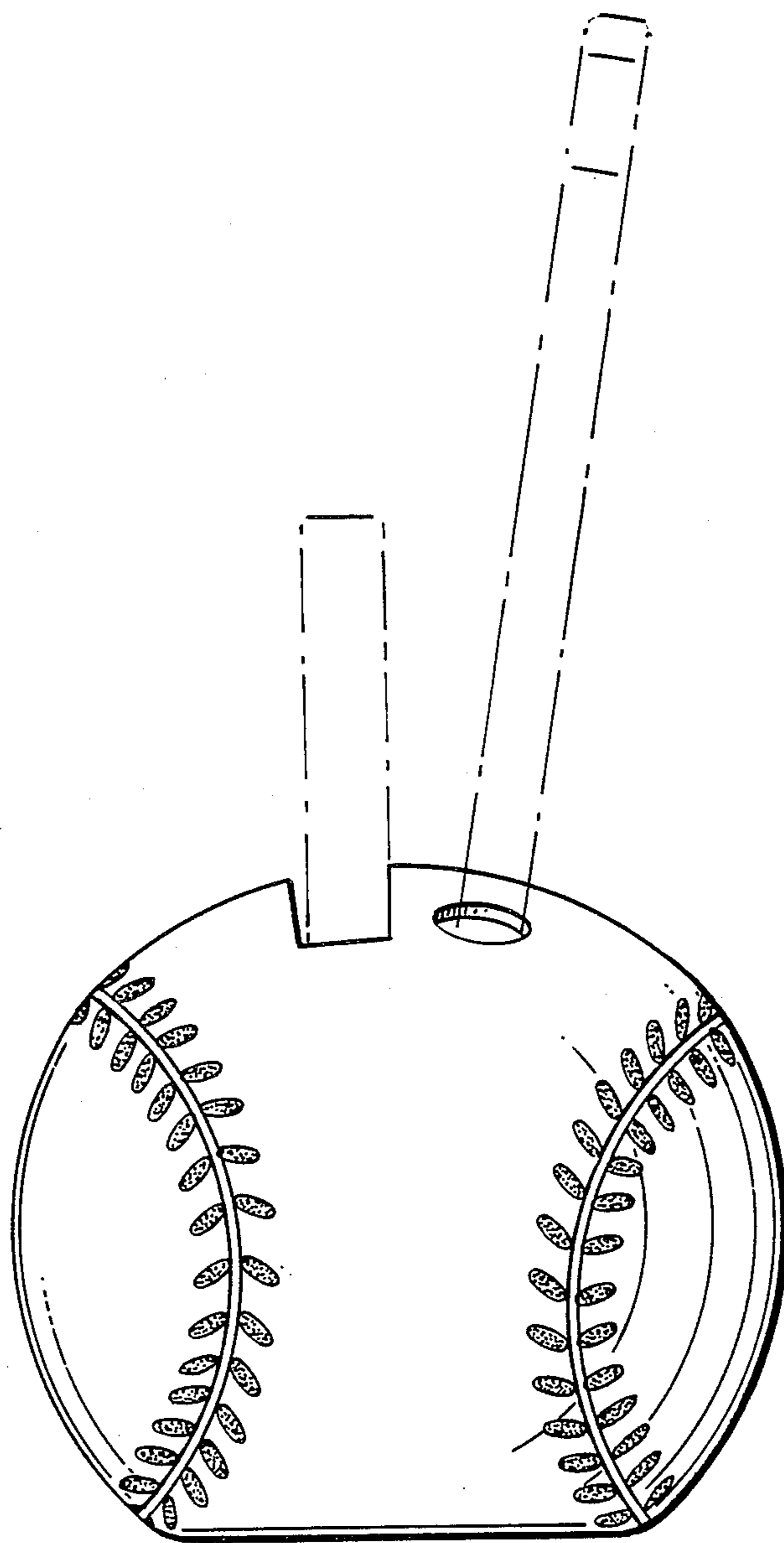

FIG. 4

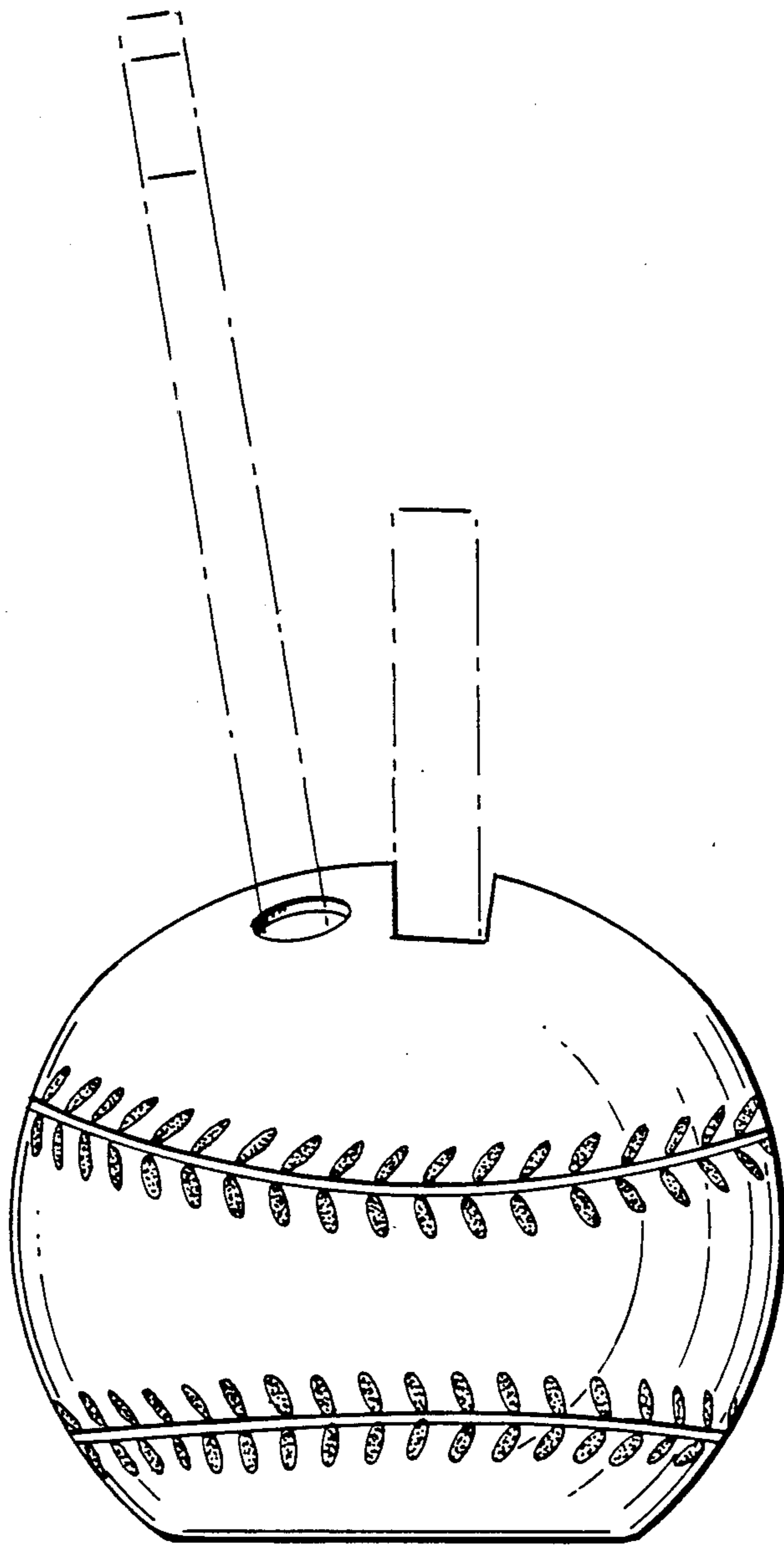

FIG. 5

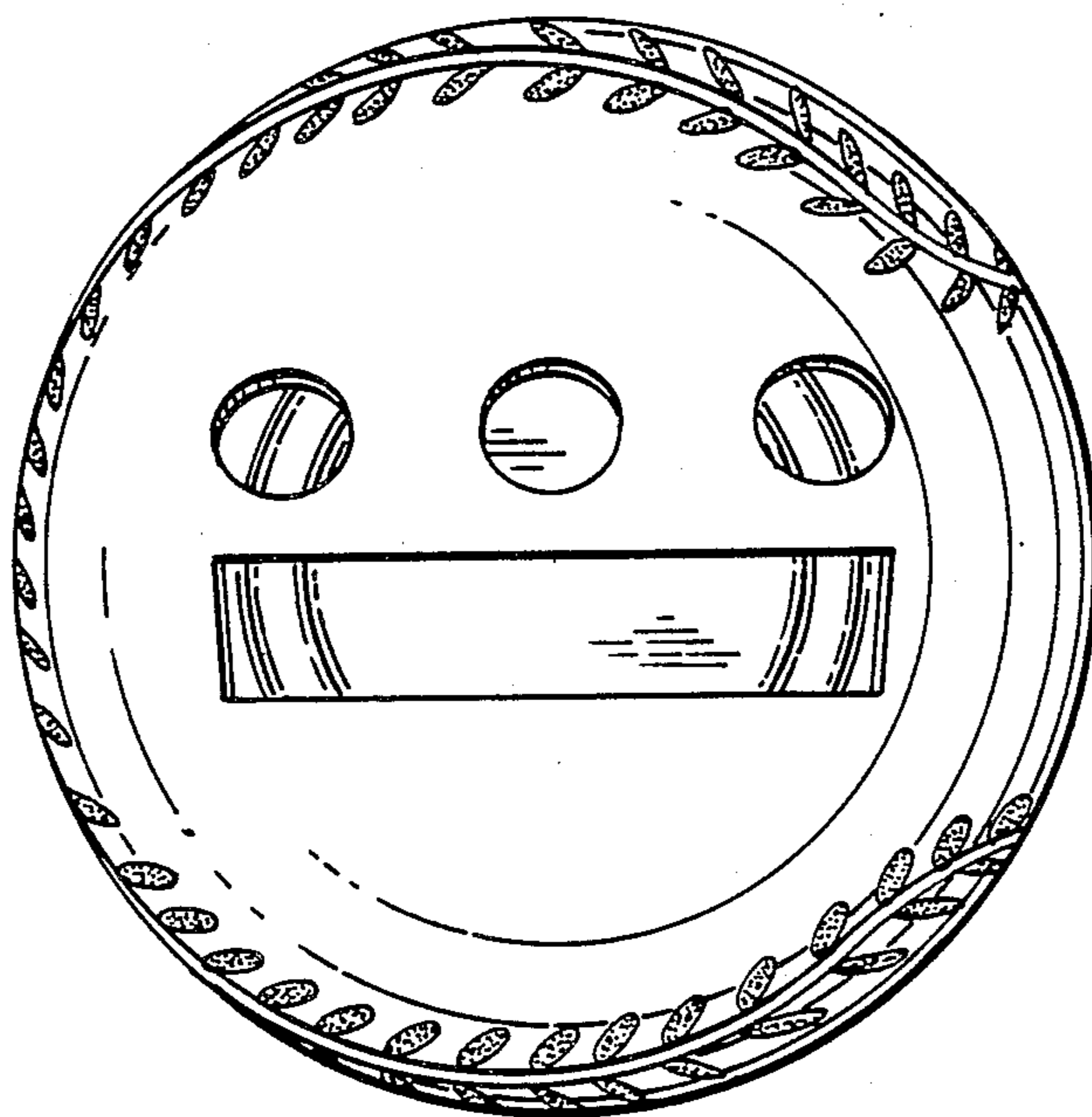

FIG. 6

