

United States Patent [19]

Kando

[11] Patent Number: Des. 292,976

[45] Date of Patent: ** Dec. 1, 1987

[54] FACSIMILE

[75] Inventor: Masahiro Kando, Tokyo, Japan

[73] Assignee: Canon Kabushiki Kaisha, Tokyo, Japan

[**] Term: 14 Years

[21] Appl. No.: 757,340

[22] Filed: Jul. 22, 1985

[30] Foreign Application Priority Data

Jan. 28, 1985 [JP] Japan 60-2637
[52] U.S. Cl. D14/94; D14/53
[58] Field of Search D14/94, 52, 53; D16/27,
D16/30, 31, 32; 358/256, 285, 286

[56] References Cited

U.S. PATENT DOCUMENTS

D. 218,170 7/1970 Kober D14/94
D. 264,846 6/1982 Taguchi D14/94

D. 280,508 9/1985 Nasui et al. D14/94
D. 282,165 1/1986 Brown D14/53
D. 282,365 1/1986 Hayashida D14/94

Primary Examiner—Bernard Ansher
Assistant Examiner—Theodore M. Shooman
Attorney, Agent, or Firm—Fitzpatrick, Cella, Harper & Scinto

[57] CLAIM

The ornamental design for a facsimile, as shown and described.

DESCRIPTION

FIG. 1 is a front elevational view of a facsimile showing my new design;
FIG. 2 is a rear elevational view thereof;
FIG. 3 is a top plan view thereof;
FIG. 4 is a bottom plan view thereof;
FIG. 5 is a left side elevational view thereof;
FIG. 6 is a right side elevational view thereof; and
FIG. 7 is a top, front and left side perspective view thereof.

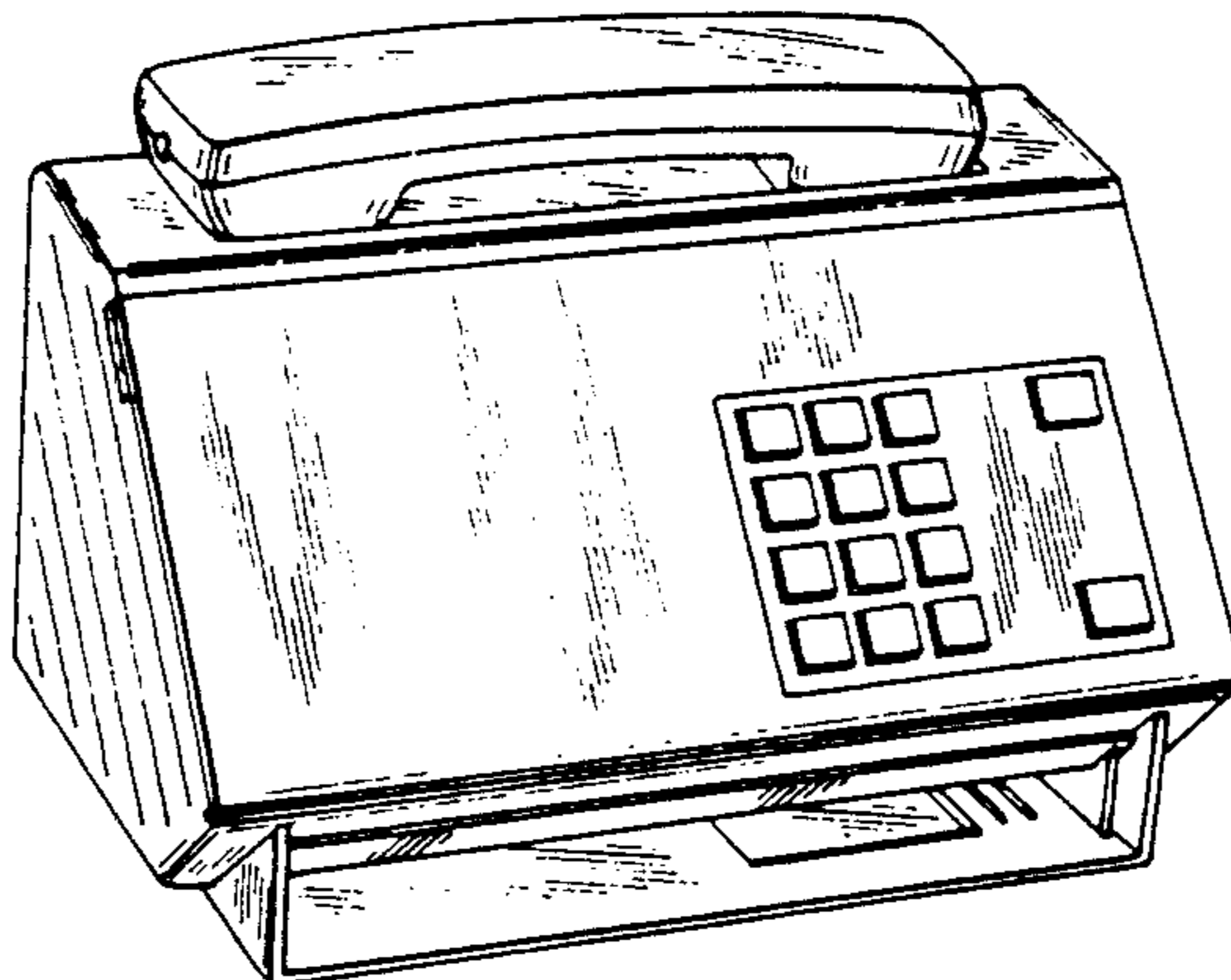

FIG. 1

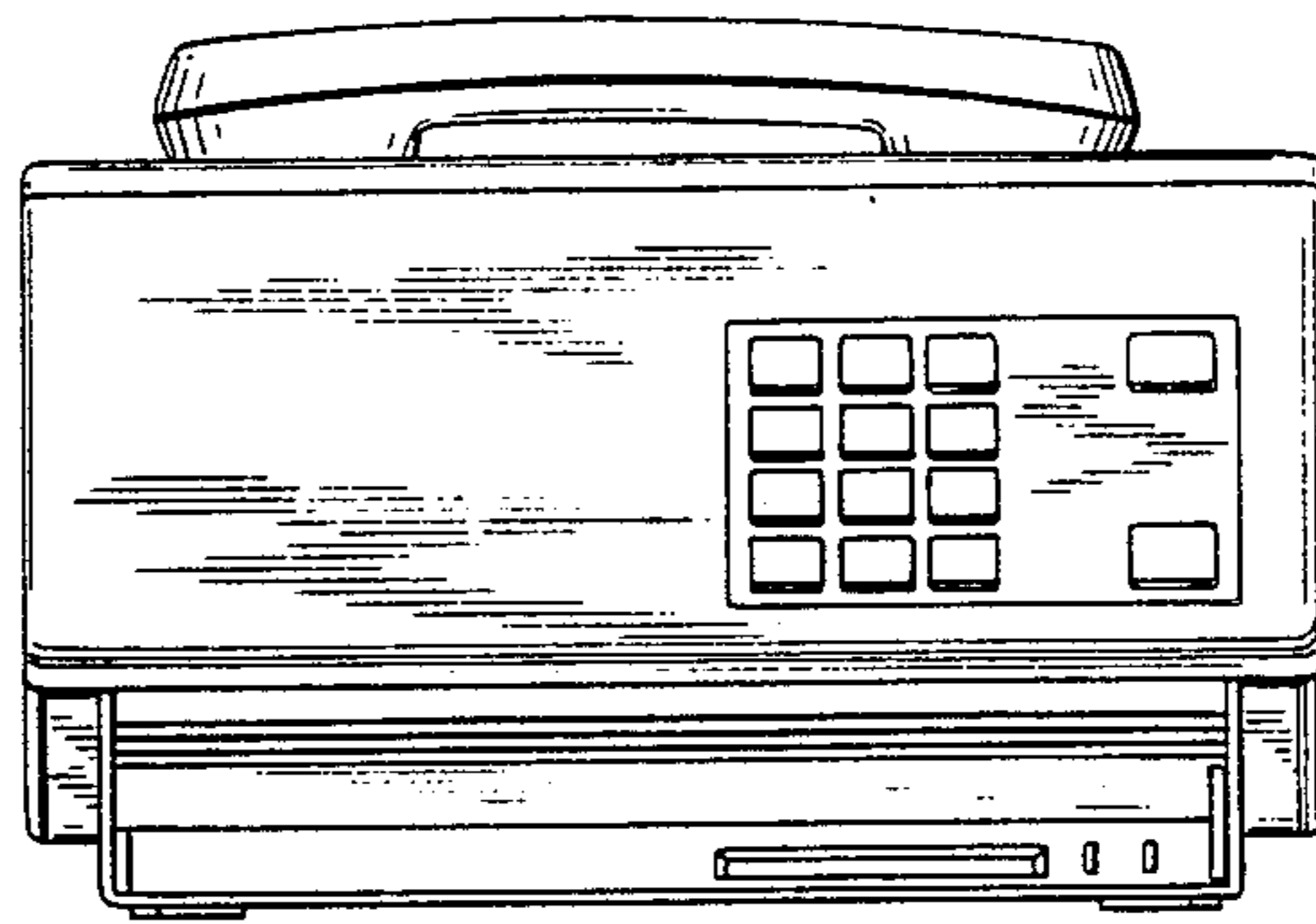

FIG. 2

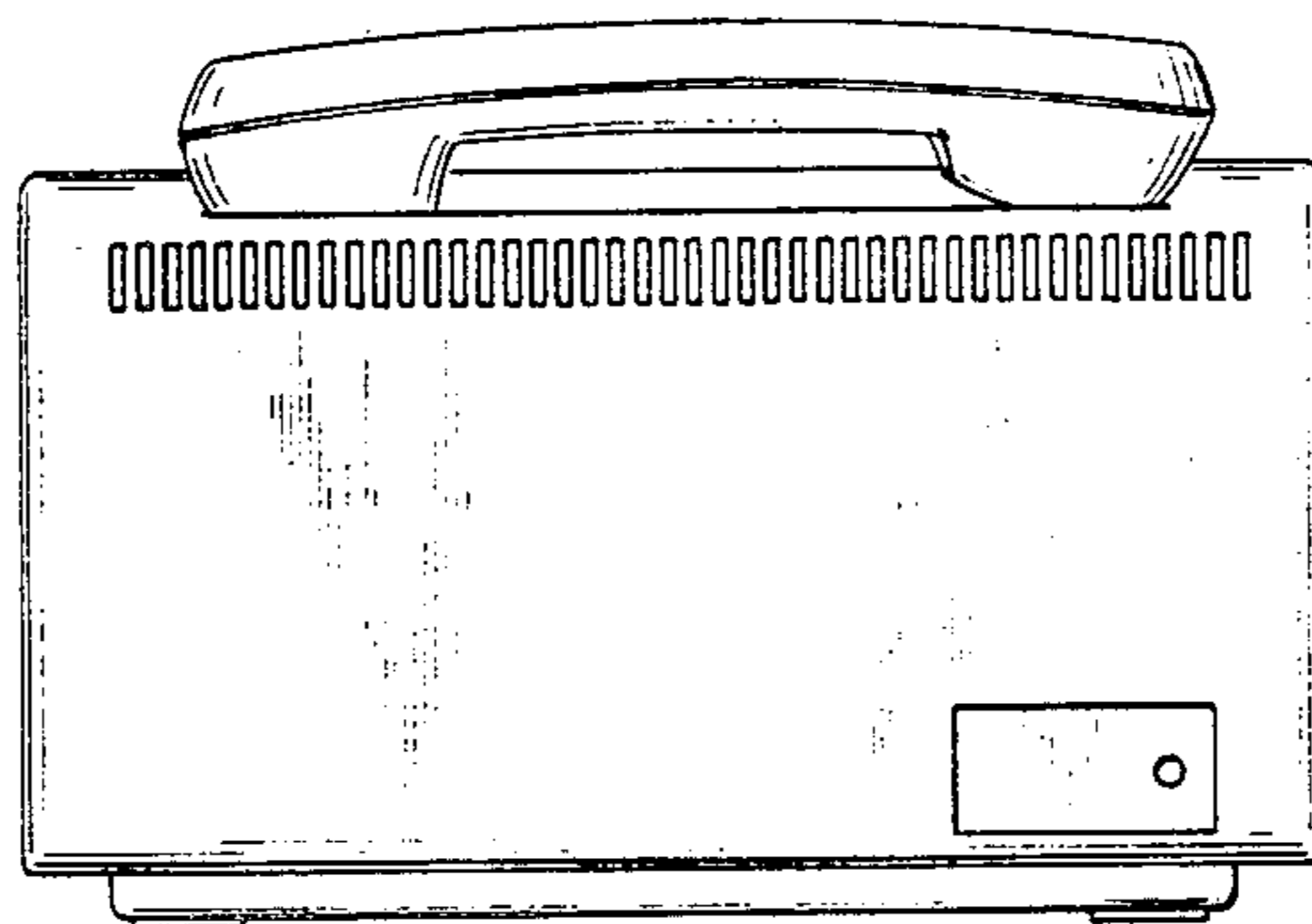

FIG. 3

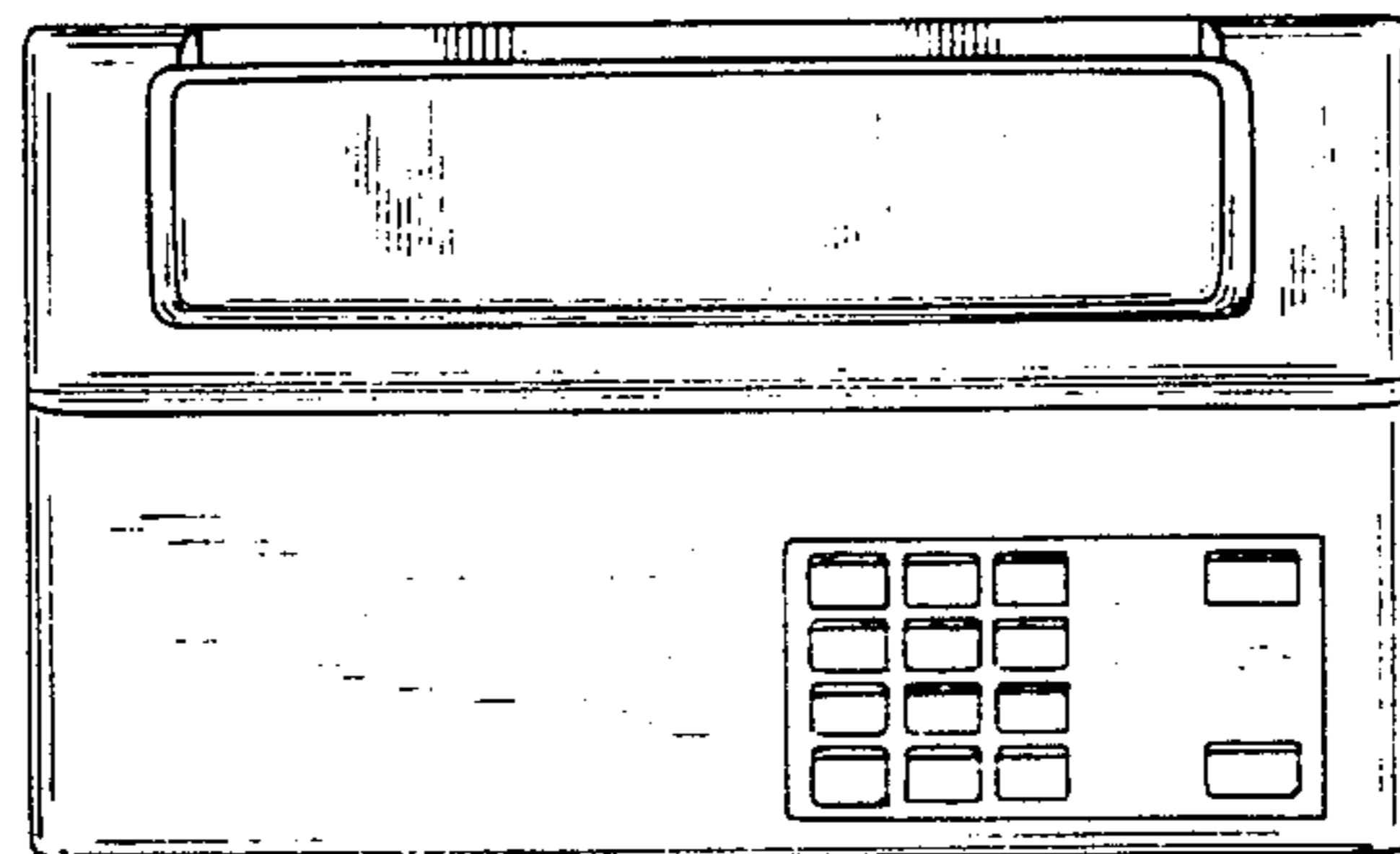

FIG. 4

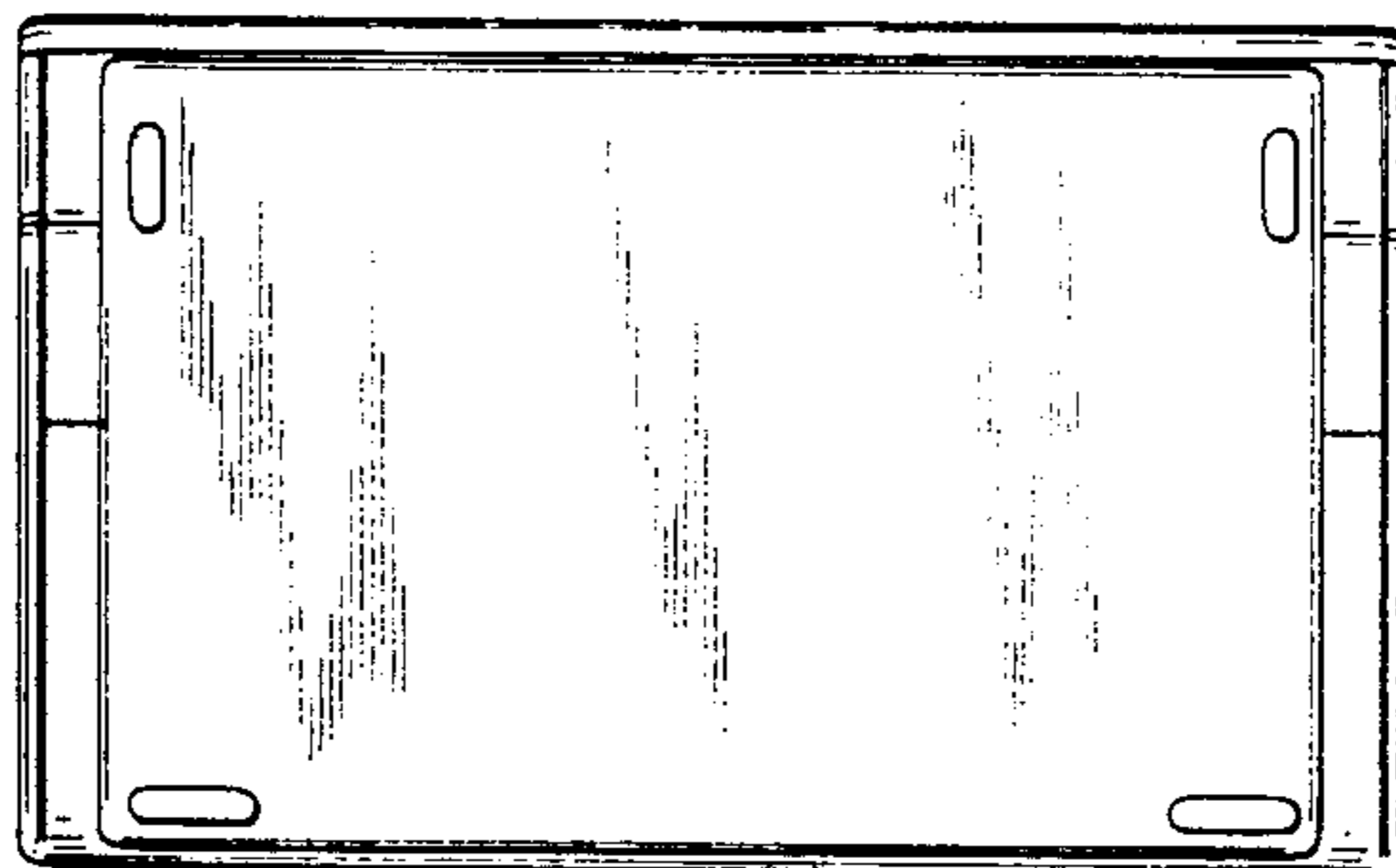

FIG. 5

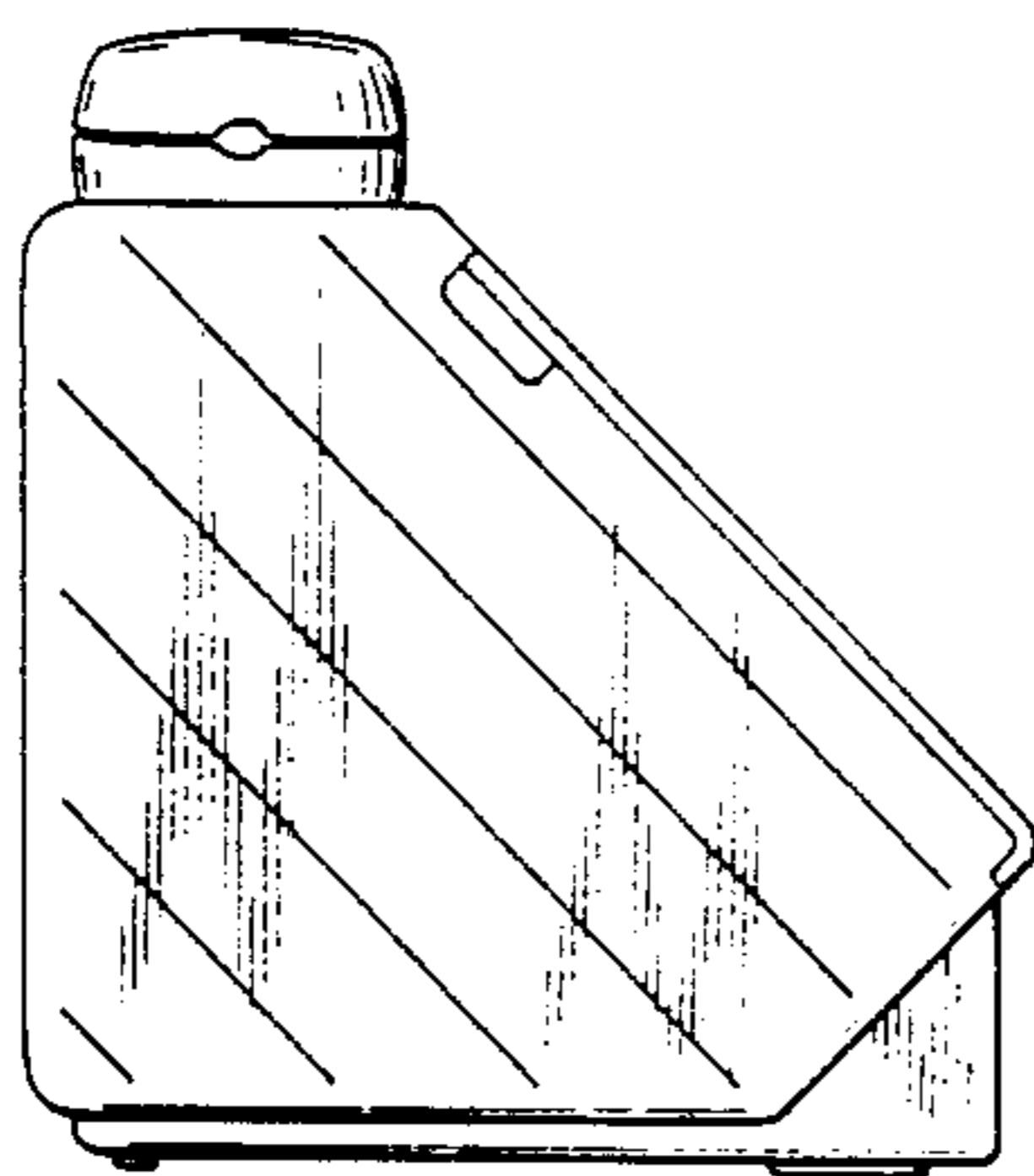

FIG. 6

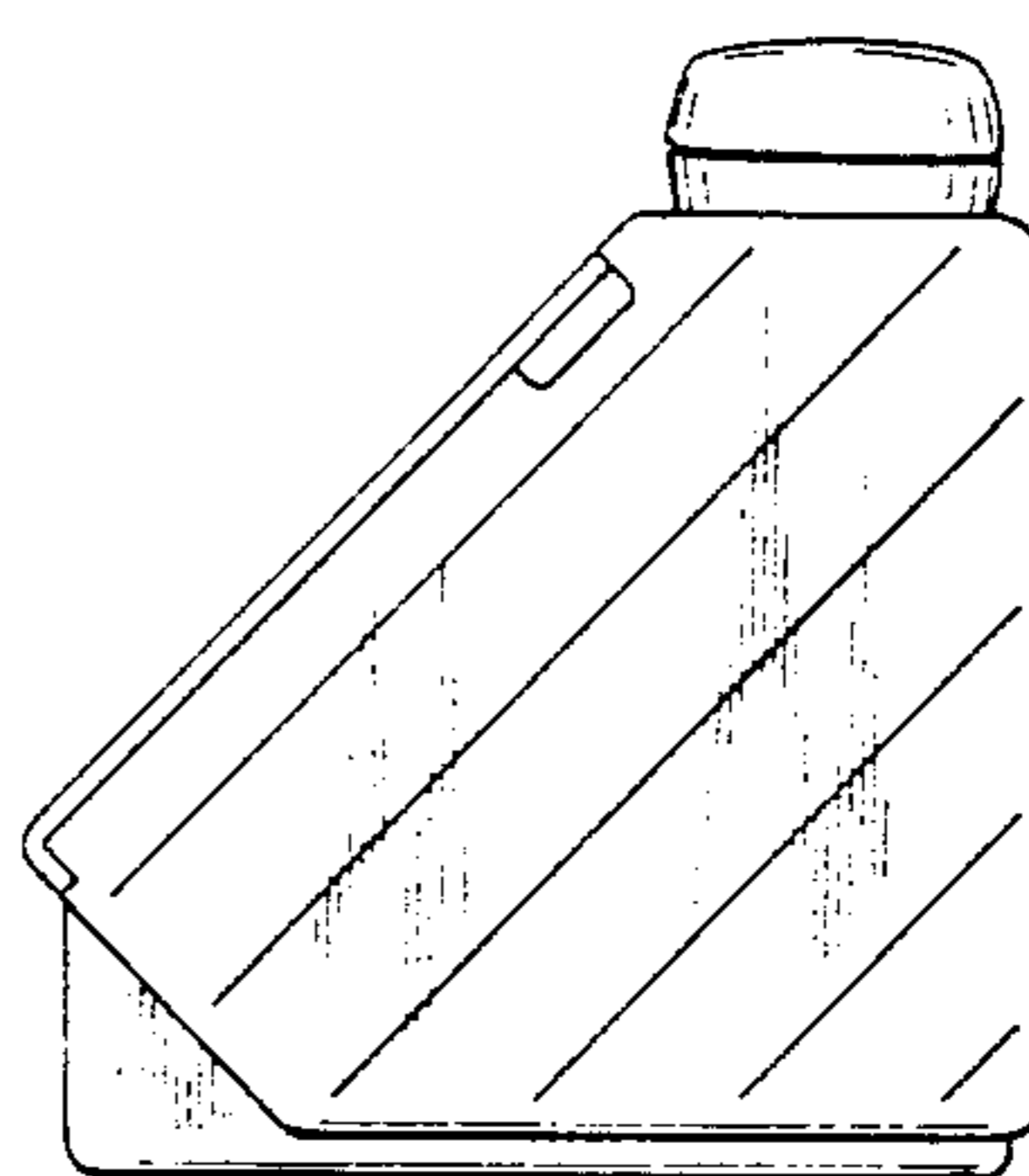

FIG. 7

