

United States Patent [19]

Tarlton et al.

[11] Patent Number: **Des. 292,938**

[45] Date of Patent: **** Nov. 24, 1987**

[54] **SPIRAL CONVEYOR**

[75] Inventors: **Curtis S. Tarlton**, Florham Park;
Richard A. Ford, Blackwood, both of
N.J.

[73] Assignee: **C. & T. Tarlton, Inc.**, Union, N.J.

[**] Term: **14 Years**

[21] Appl. No.: **725,371**

[22] Filed: **Apr. 22, 1985**

[52] U.S. Cl. **D34/29**

[58] Field of Search **D34/28, 29; 198/778**

[56] **References Cited**

U.S. PATENT DOCUMENTS

3,826,352	7/1974	Van Zon et al.	198/778
3,857,476	12/1974	Heifetz et al.	198/778
4,269,302	5/1981	Garvey	198/778

FOREIGN PATENT DOCUMENTS

885832	11/1971	Canada	198/778
969501	6/1975	Canada	198/778

Primary Examiner—James M. Gandy

Assistant Examiner—Kay H. Chin

[57] **CLAIM**

The ornamental design for a spiral conveyor, substantially as shown.

DESCRIPTION

FIG. 1 is a front perspective view of a spiral conveyor showing our new design;
FIG. 2 is a top plan view thereof;
FIG. 3 is a bottom plan view thereof.
FIG. 4 is a front elevational view thereof;
FIG. 5 is a left side elevational view thereof;
FIG. 6 is a right side elevational view thereof;
FIG. 7 is a rear elevational view thereof.

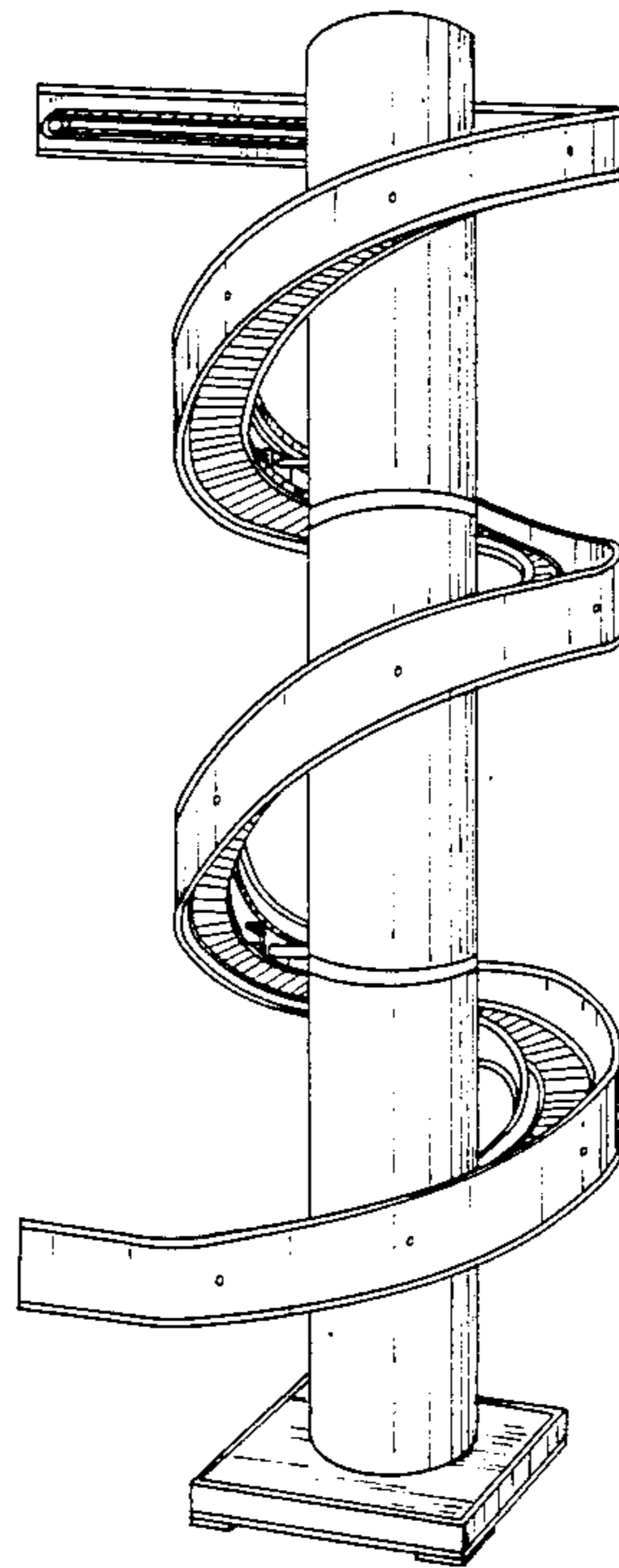

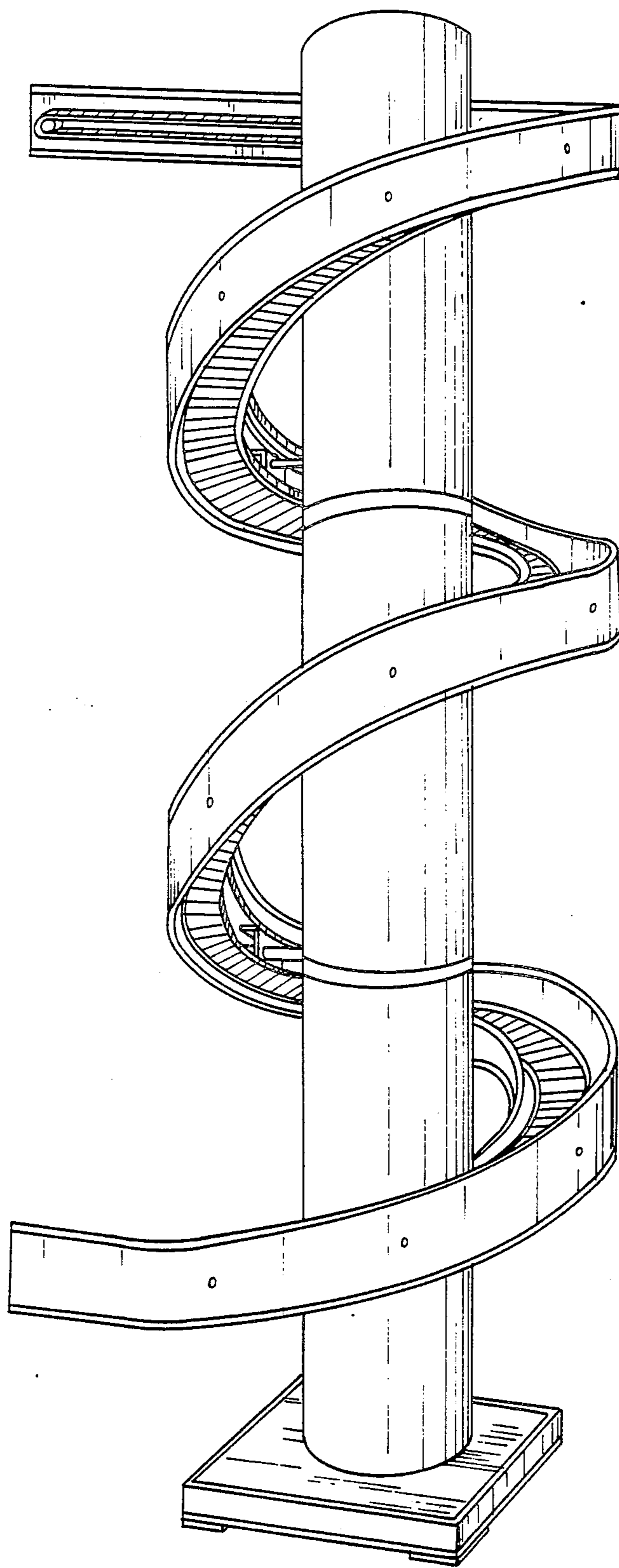

FIG. 1

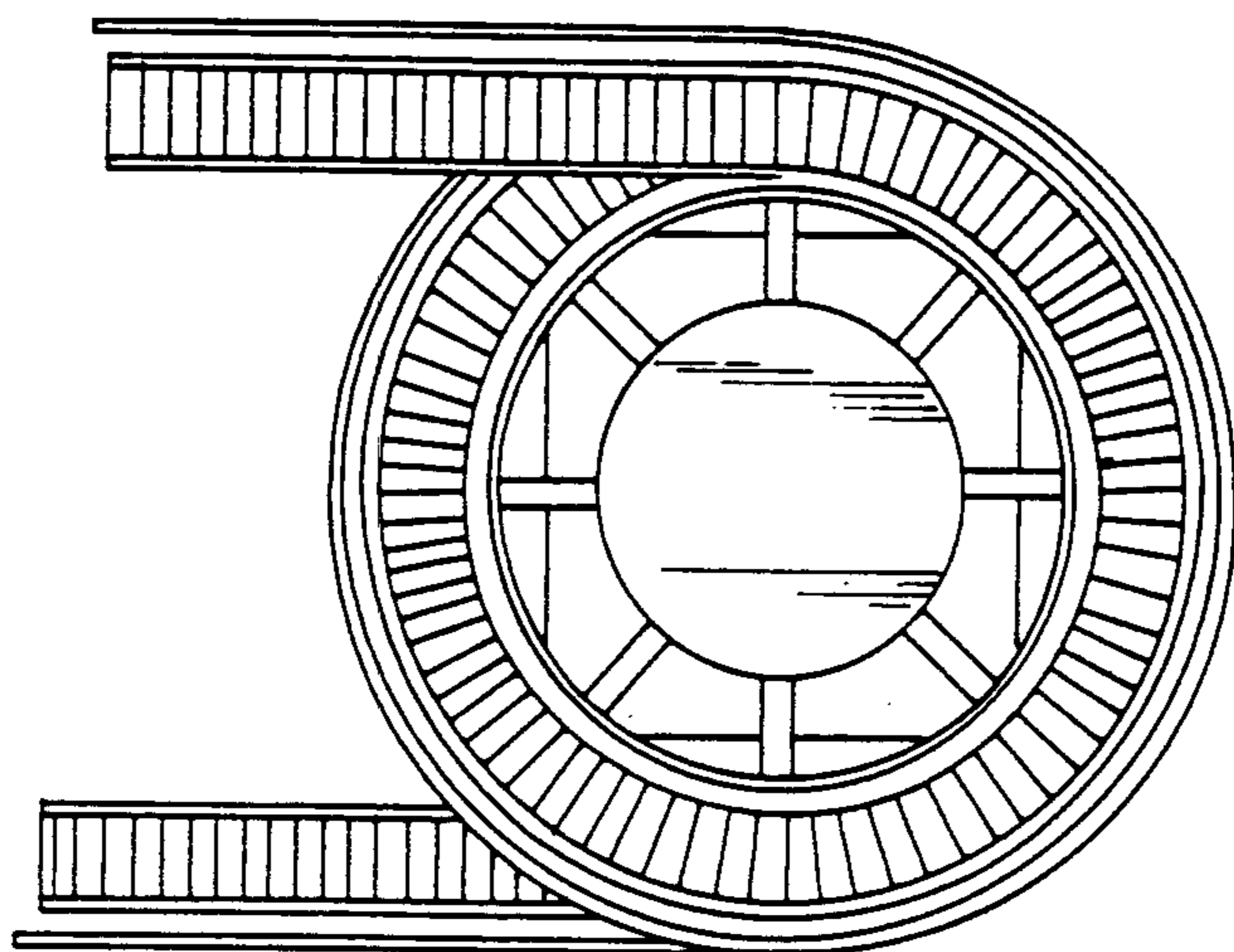

FIG. 2

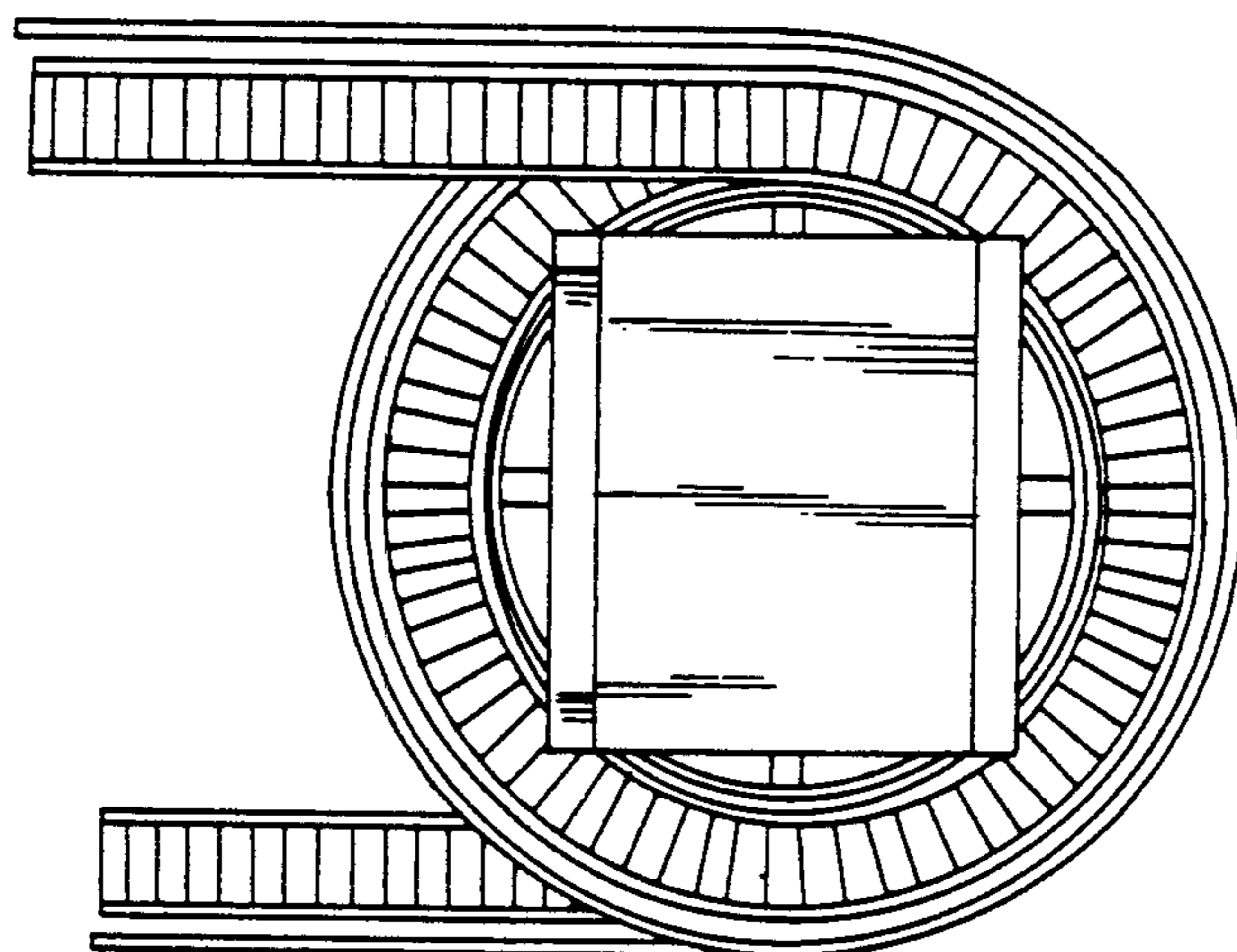

FIG. 3

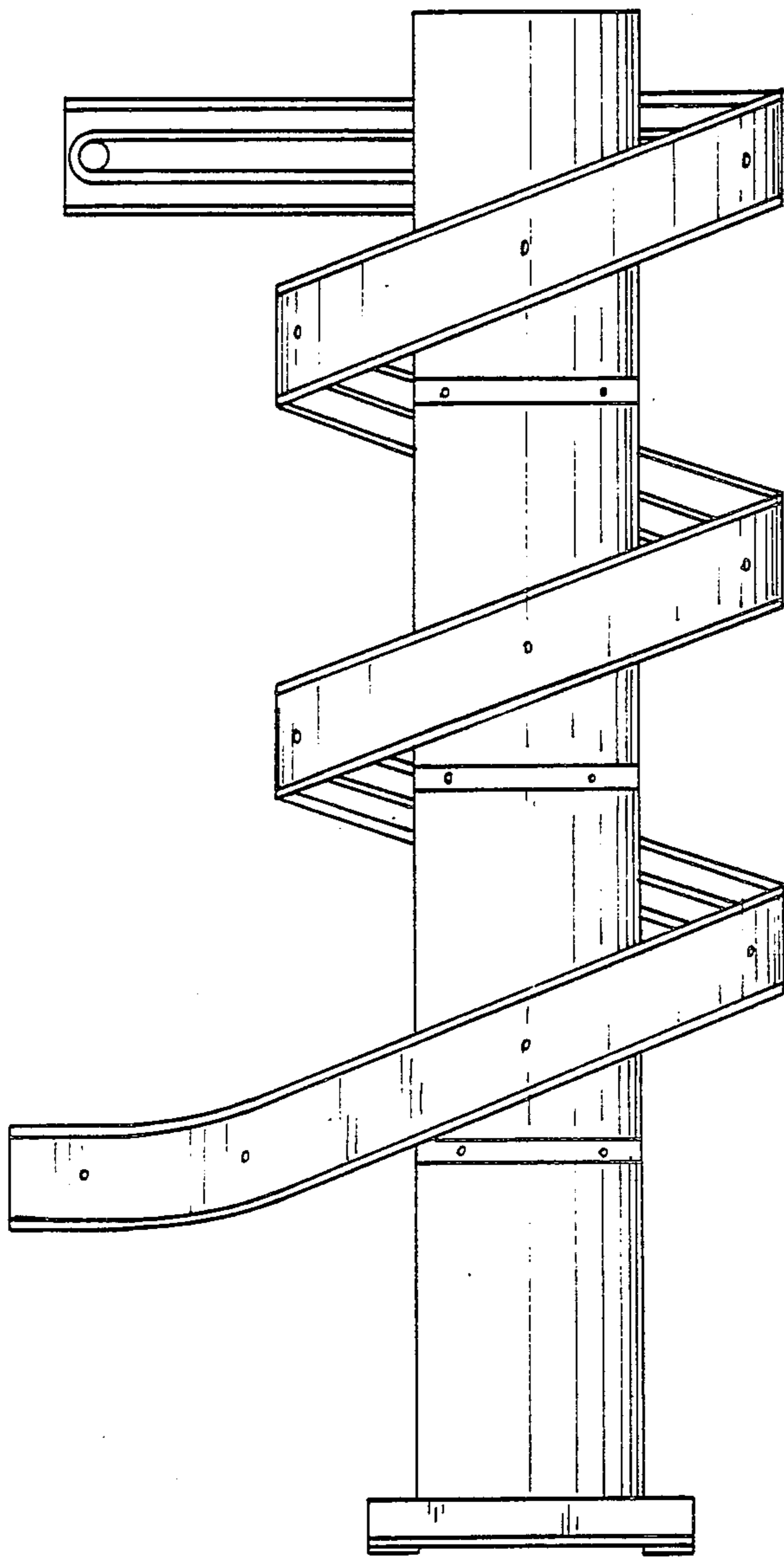

FIG. 4

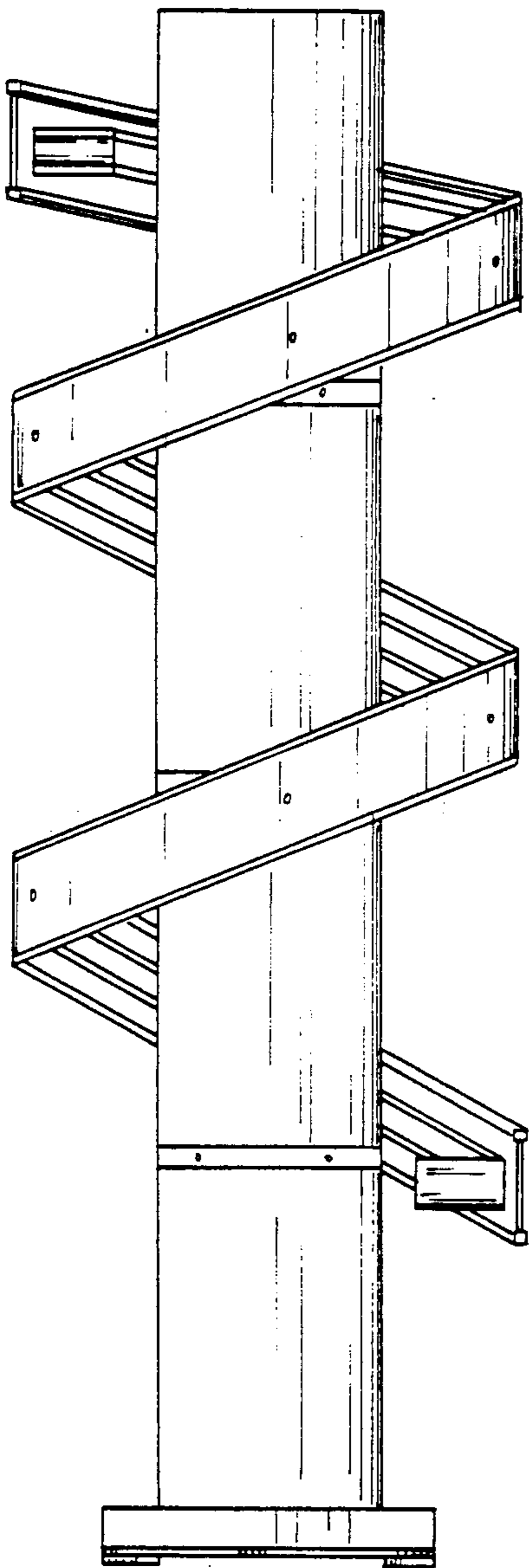

FIG. 5

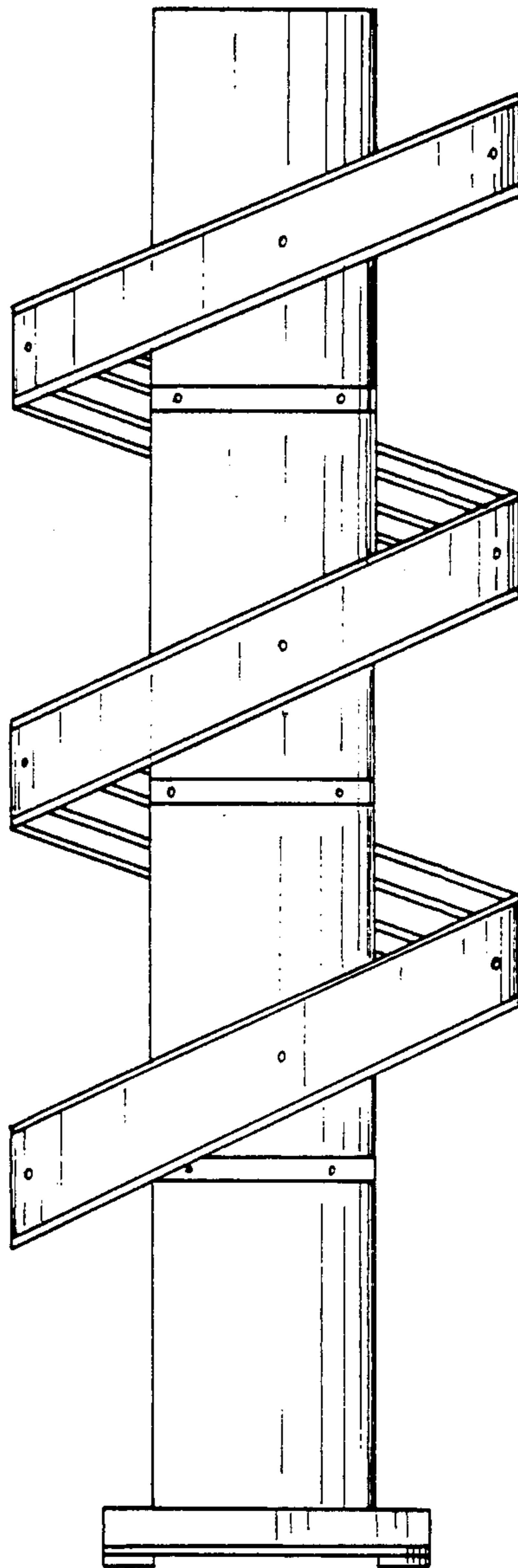

FIG. 6

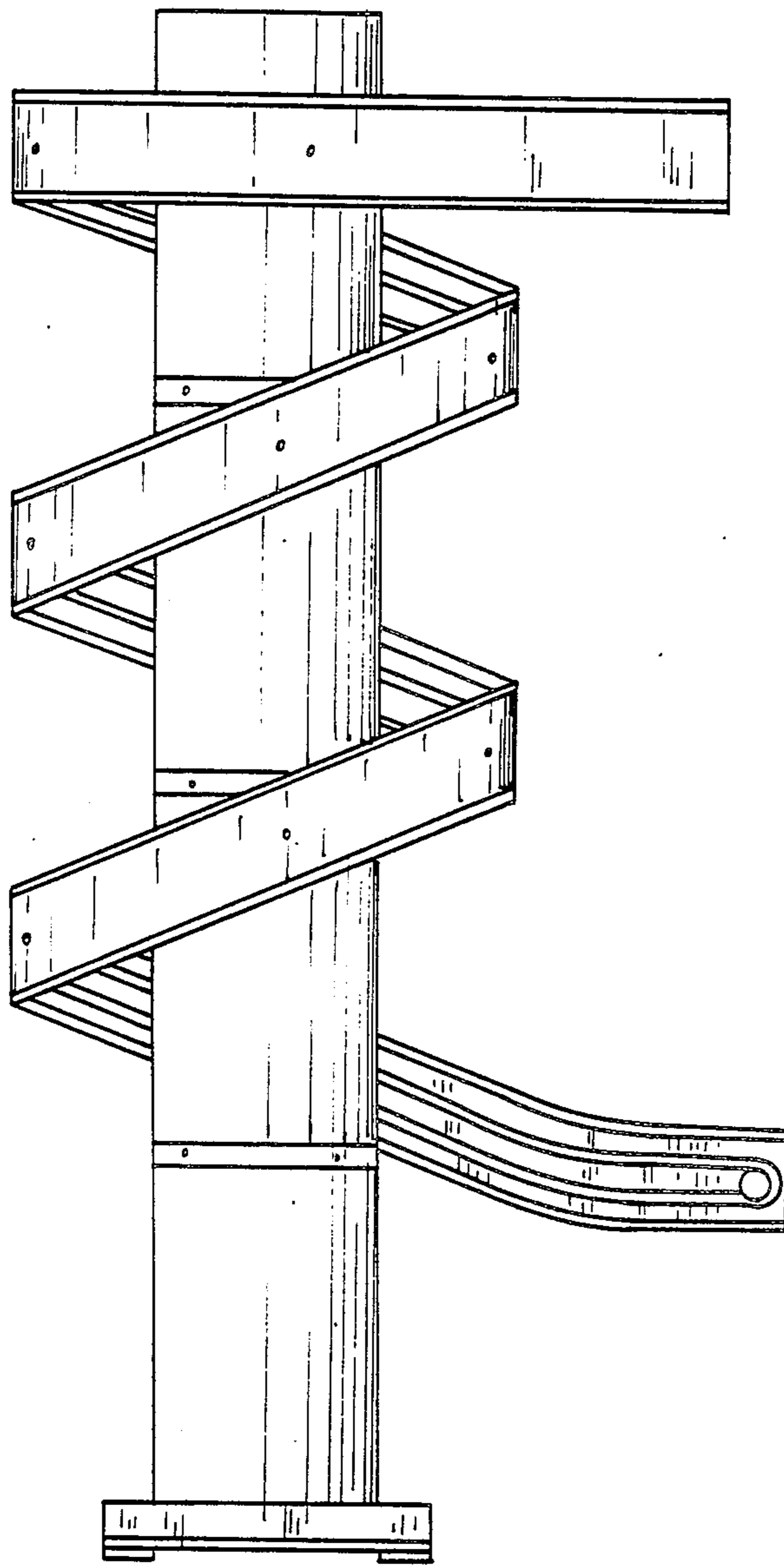

FIG. 7