

[54] IRRIGATION WATER DRAINAGE UNIT  
[76] Inventor: Daryl D. Alberico, Rte. 2, Box 219-A,  
Willows, Calif. 95988  
[\*\*] Term: 14 Years  
[21] Appl. No.: 714,409  
[22] Filed: Mar. 21, 1985  
[52] U.S. Cl. .... D23/259  
[58] Field of Search ..... D23/1, 40, 42; D8/1;  
239/193, 200; 52/302; 404/2-5; 405/87, 90,  
107-108, 36, 39-41

[56] References Cited

U.S. PATENT DOCUMENTS

D. 259,950	7/1981	Henry	.....	D23/42
2,257,626	9/1941	Thomson	.....	405/40 X
2,582,515	1/1952	Warp	.....	405/40
2,928,251	3/1960	Waring	.....	405/90
3,701,260	10/1972	Soileau	.....	405/40

OTHER PUBLICATIONS

Noland Co. Plumbing & Heating Supplies "Catalogue E", p. E86, Hotstream Automatic Draft Regulator (1943).

Primary Examiner—B. J. Bullock  
Assistant Examiner—Brian N. Vinson

Attorney, Agent, or Firm—Lothrop & West

[57] CLAIM

The ornamental design for an irrigation water drainage unit, as shown and described.

DESCRIPTION

FIG. 1 is a top front perspective view of an irrigation water drainage unit, showing my new design; FIG. 2 is an elevational view of one side thereof, the opposite side being a mirror image thereof; FIG. 3 is a rear elevational view thereof; FIG. 4 is a front elevational view thereof; FIG. 5 is a top plan view thereof; FIG. 6 is a bottom plan view thereof; FIG. 7 is a top front perspective view of a second embodiment thereof; FIG. 8 is an elevational view of one side of the embodiment of FIG. 7, the opposite side being a mirror image thereof; FIG. 9 is a rear elevational view of the embodiment of FIG. 7; FIG. 10 is a front elevational view of the embodiment of FIG. 7; FIG. 11 is a top plan view of the embodiment of FIG. 7; and FIG. 12 is a bottom plan view of the embodiment of FIG. 7.

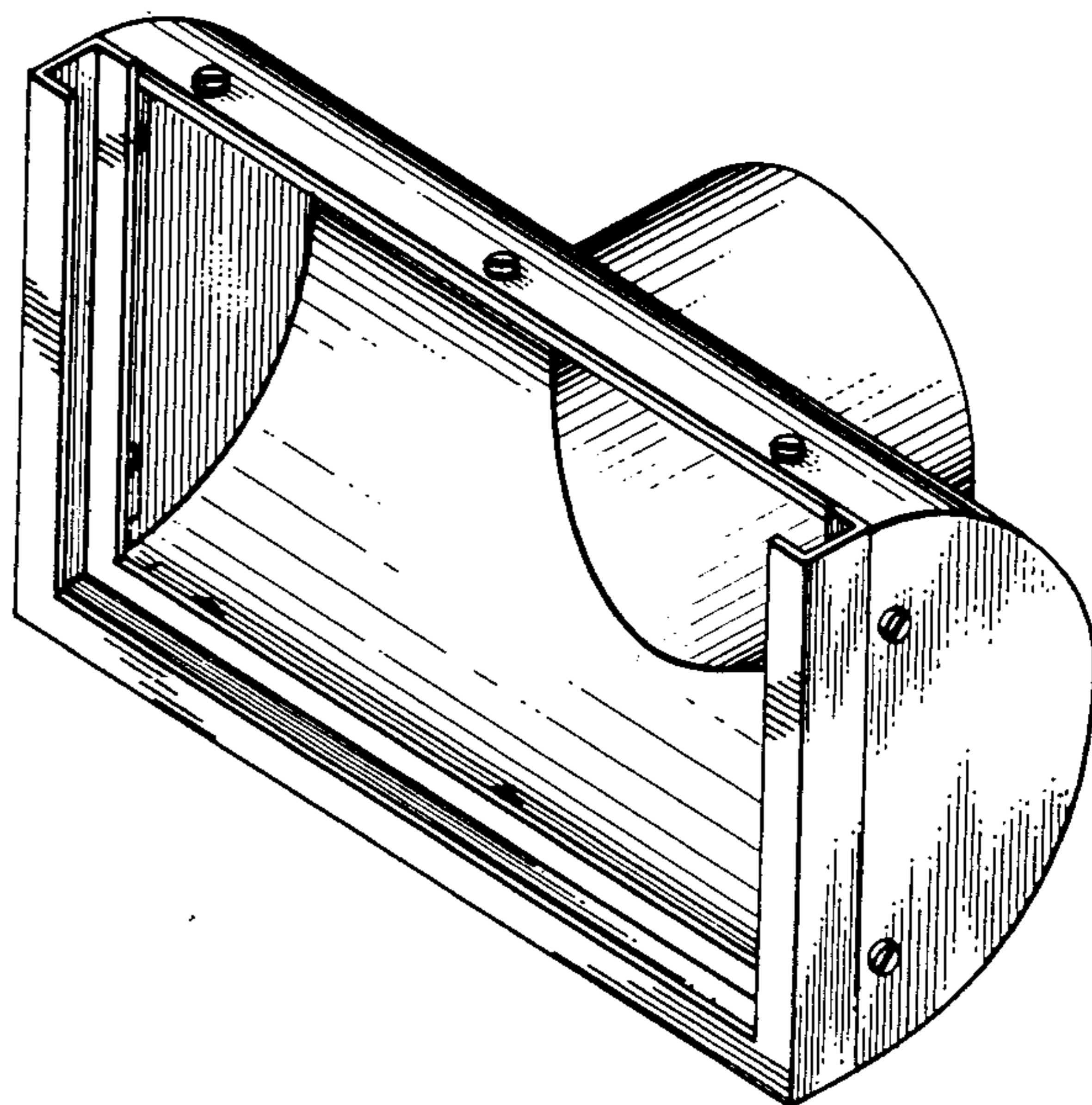
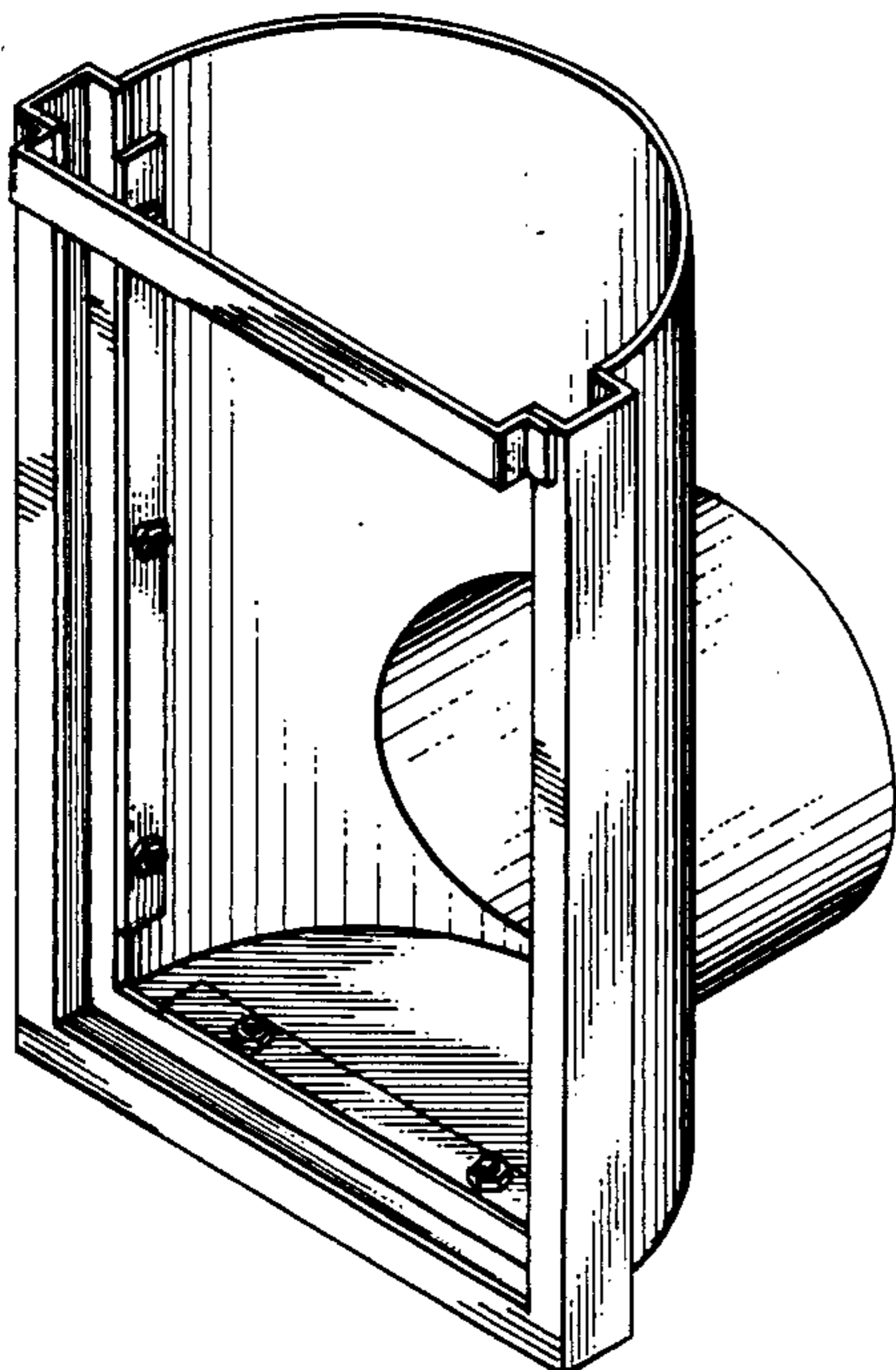

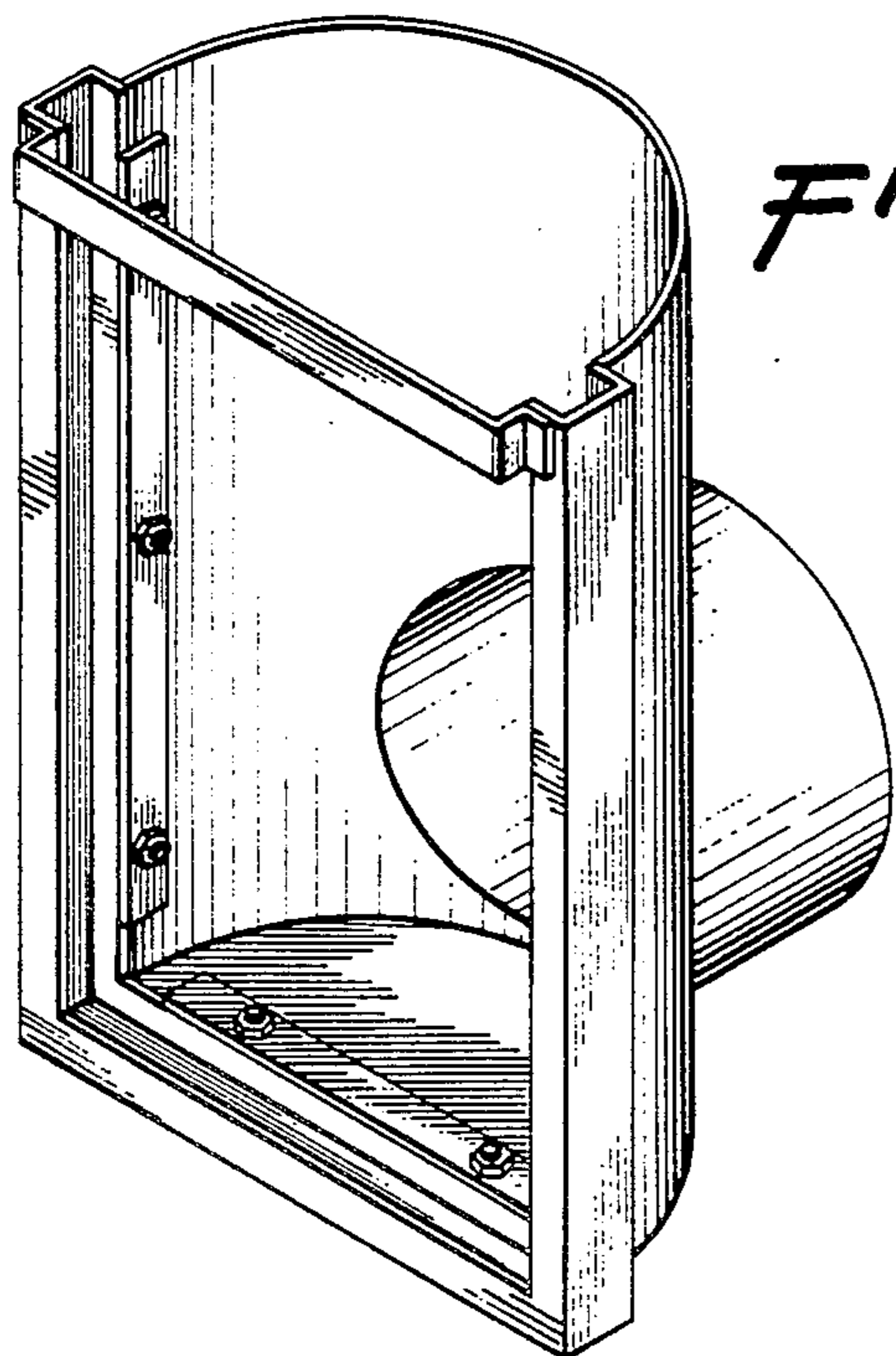

FIG-1

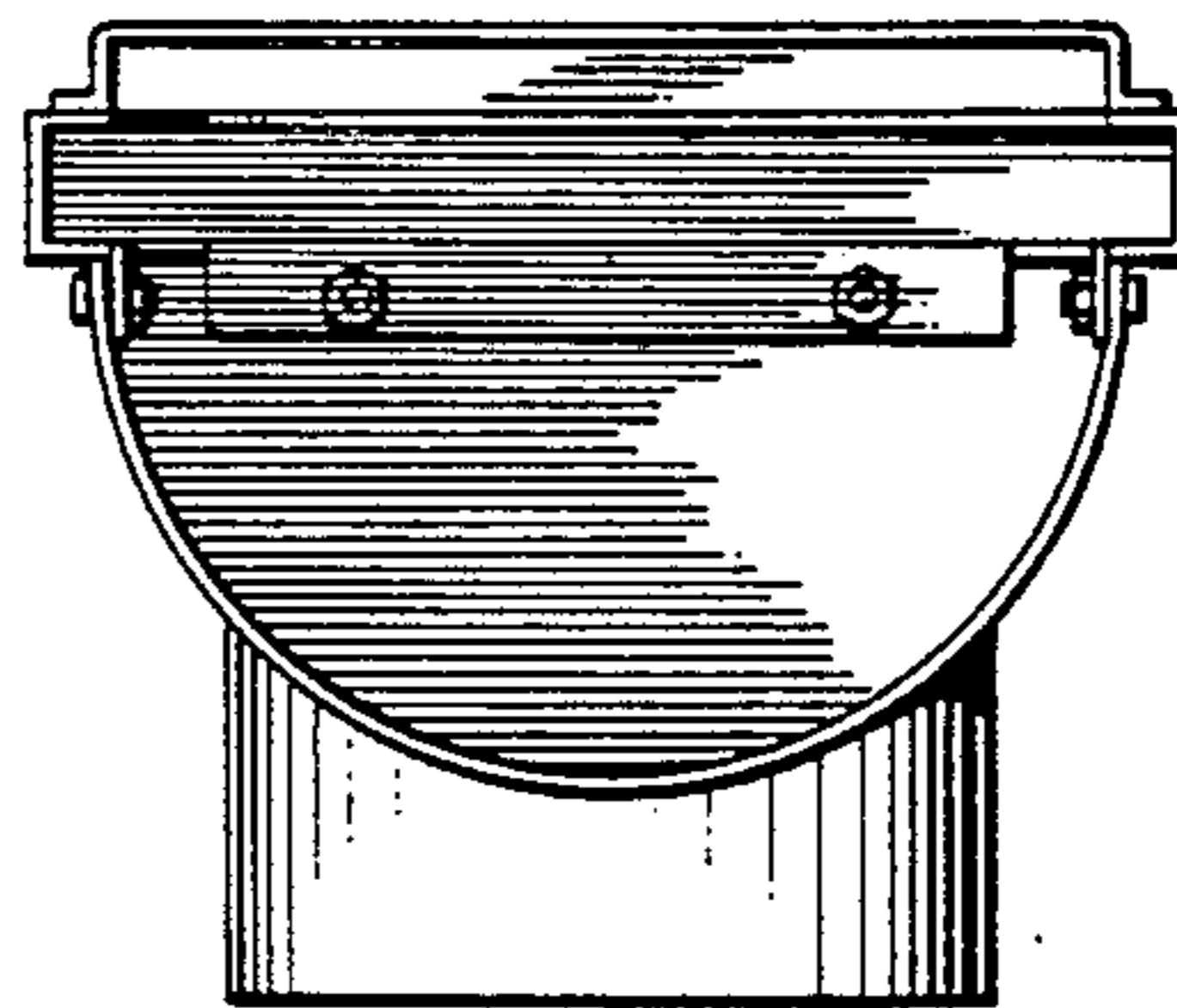

FIG-5

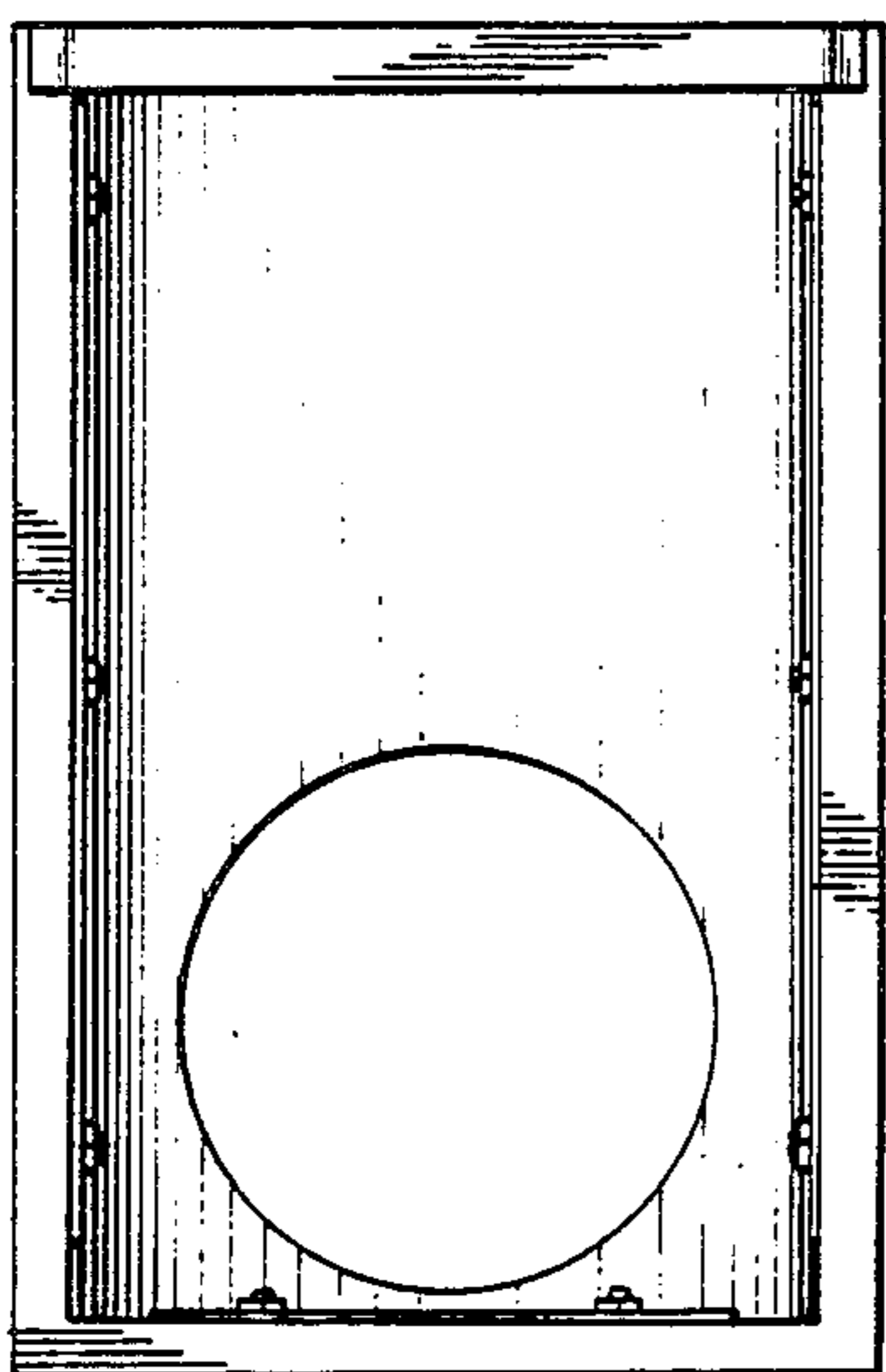

FIG-4

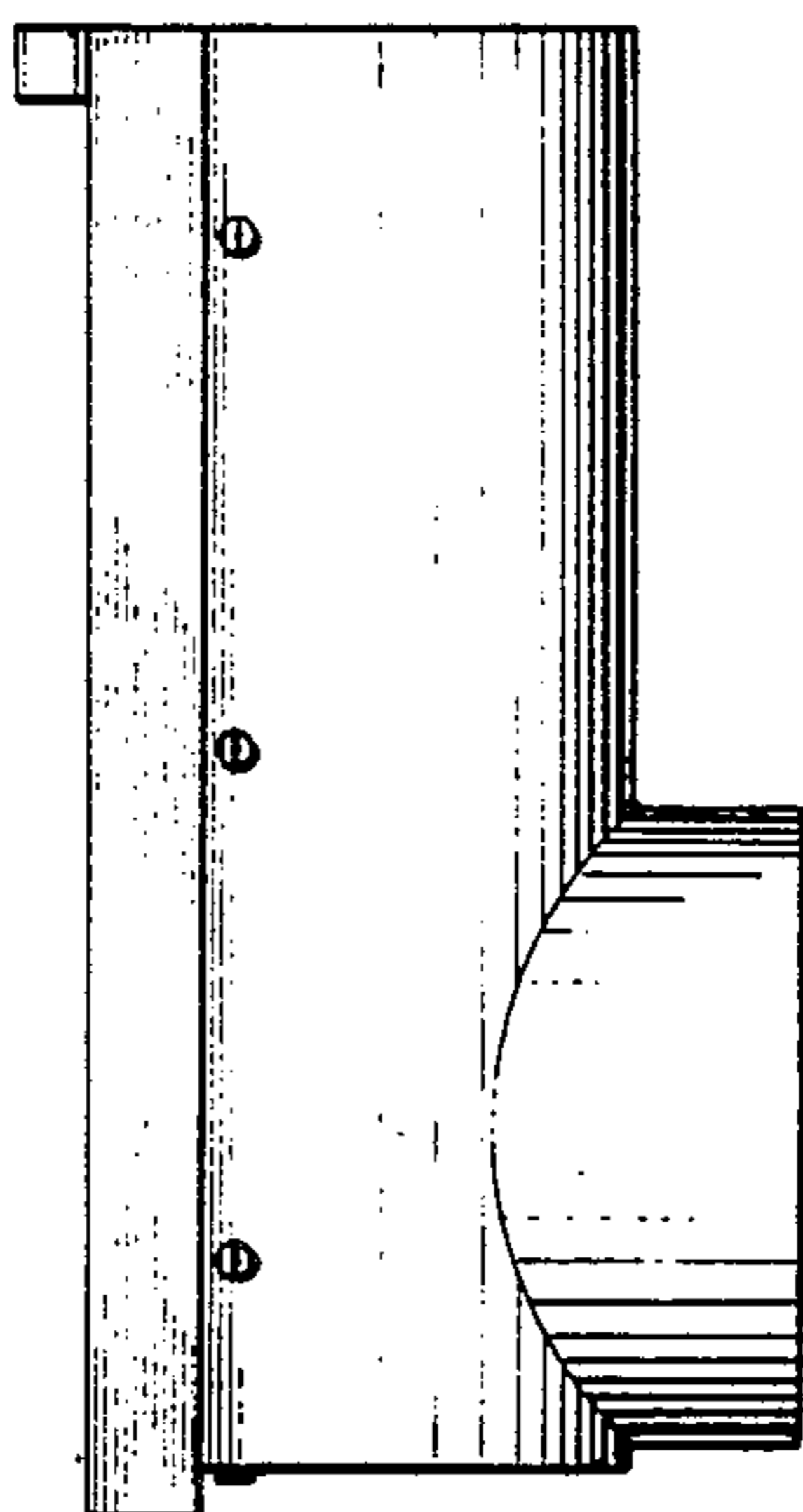

FIG-2

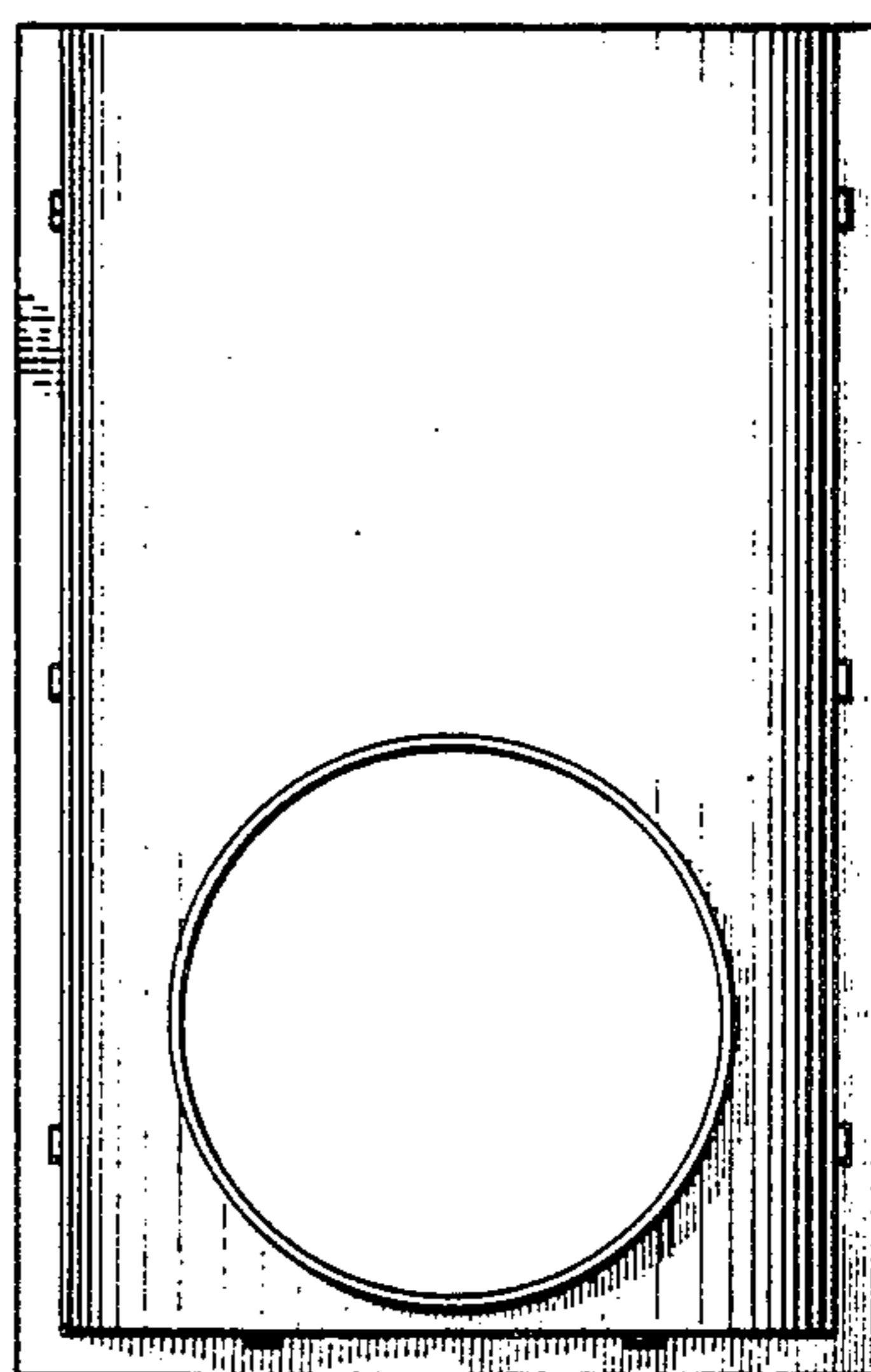

FIG-3

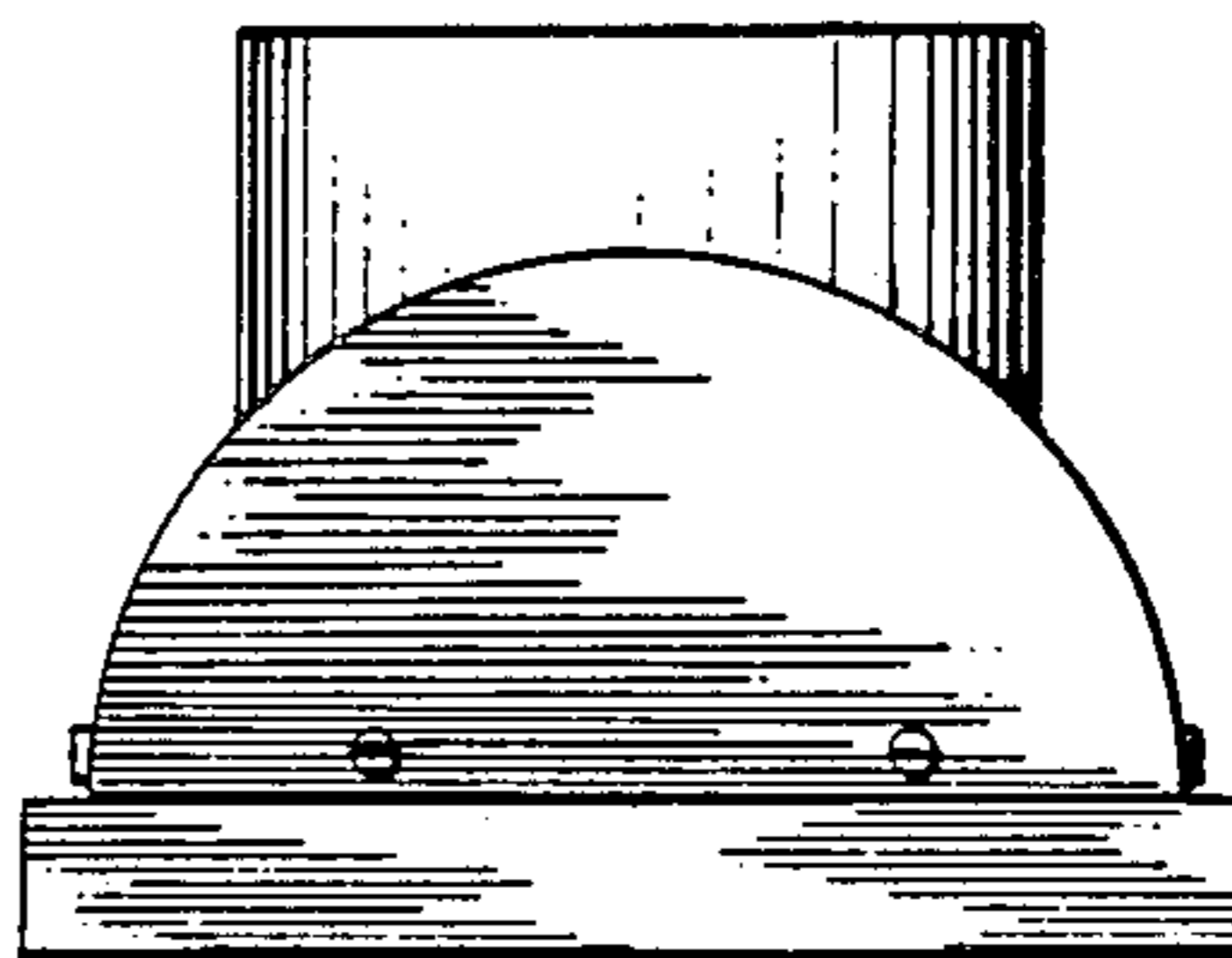

FIG-6

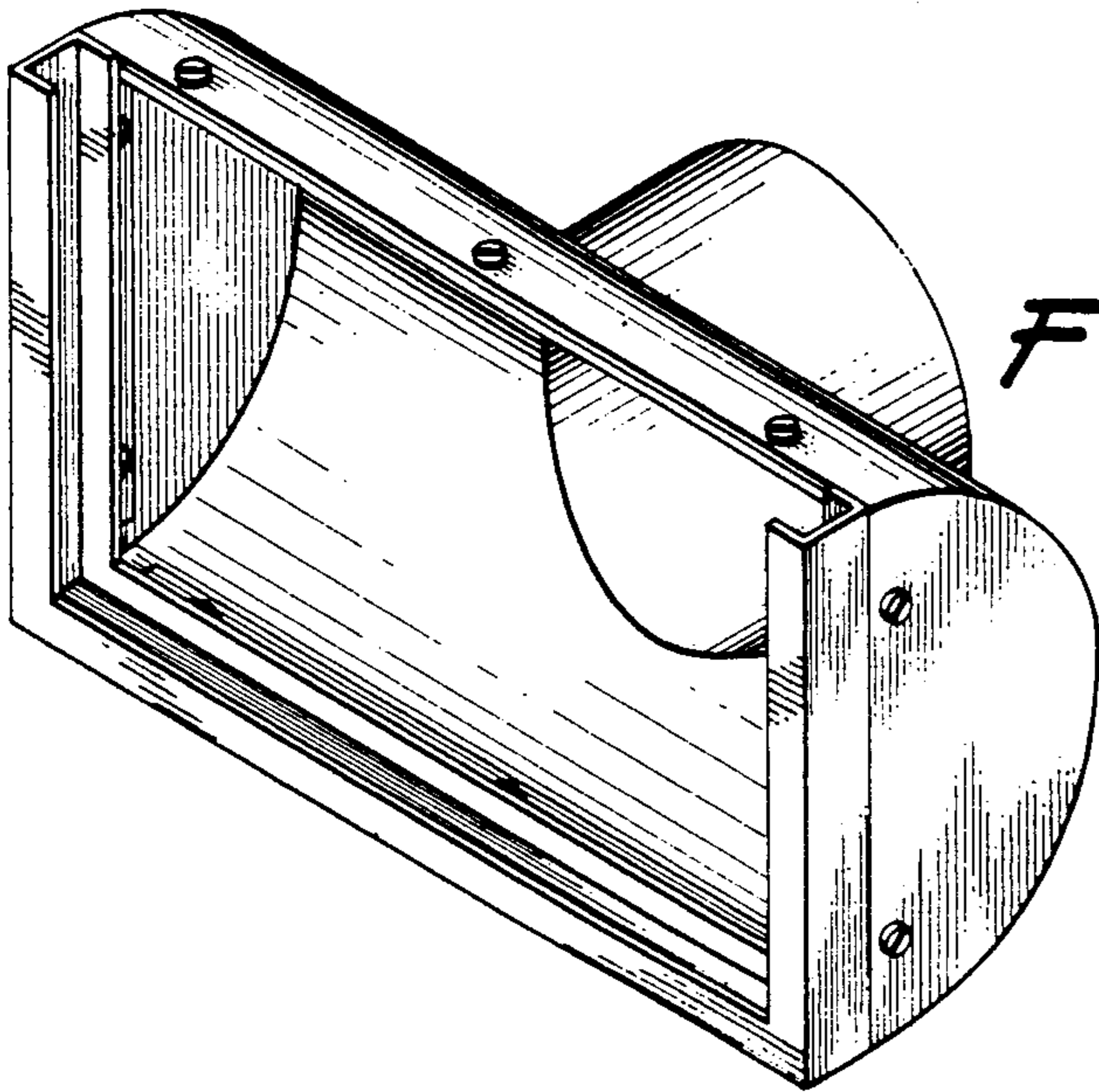

FIG-7

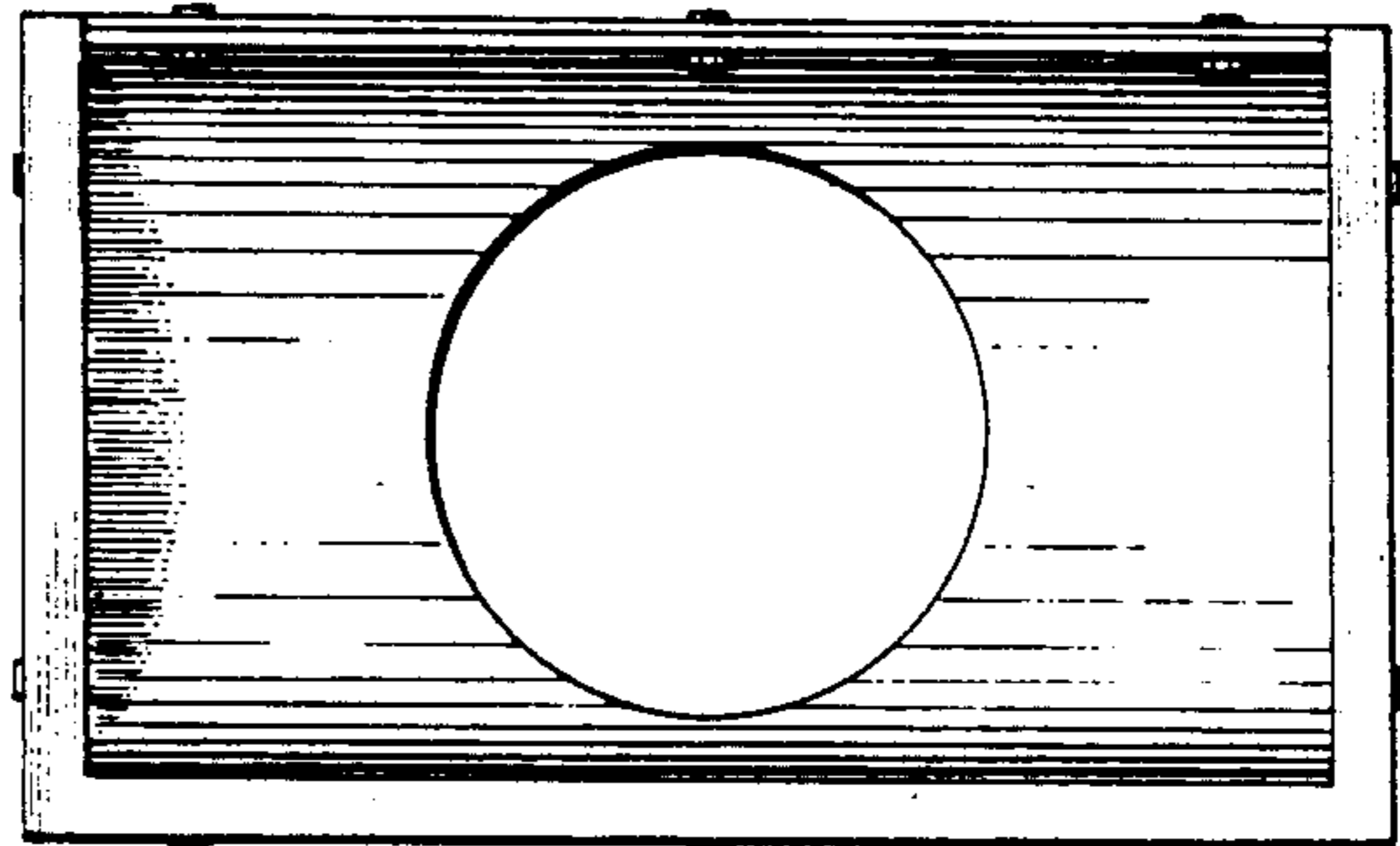

FIG-10

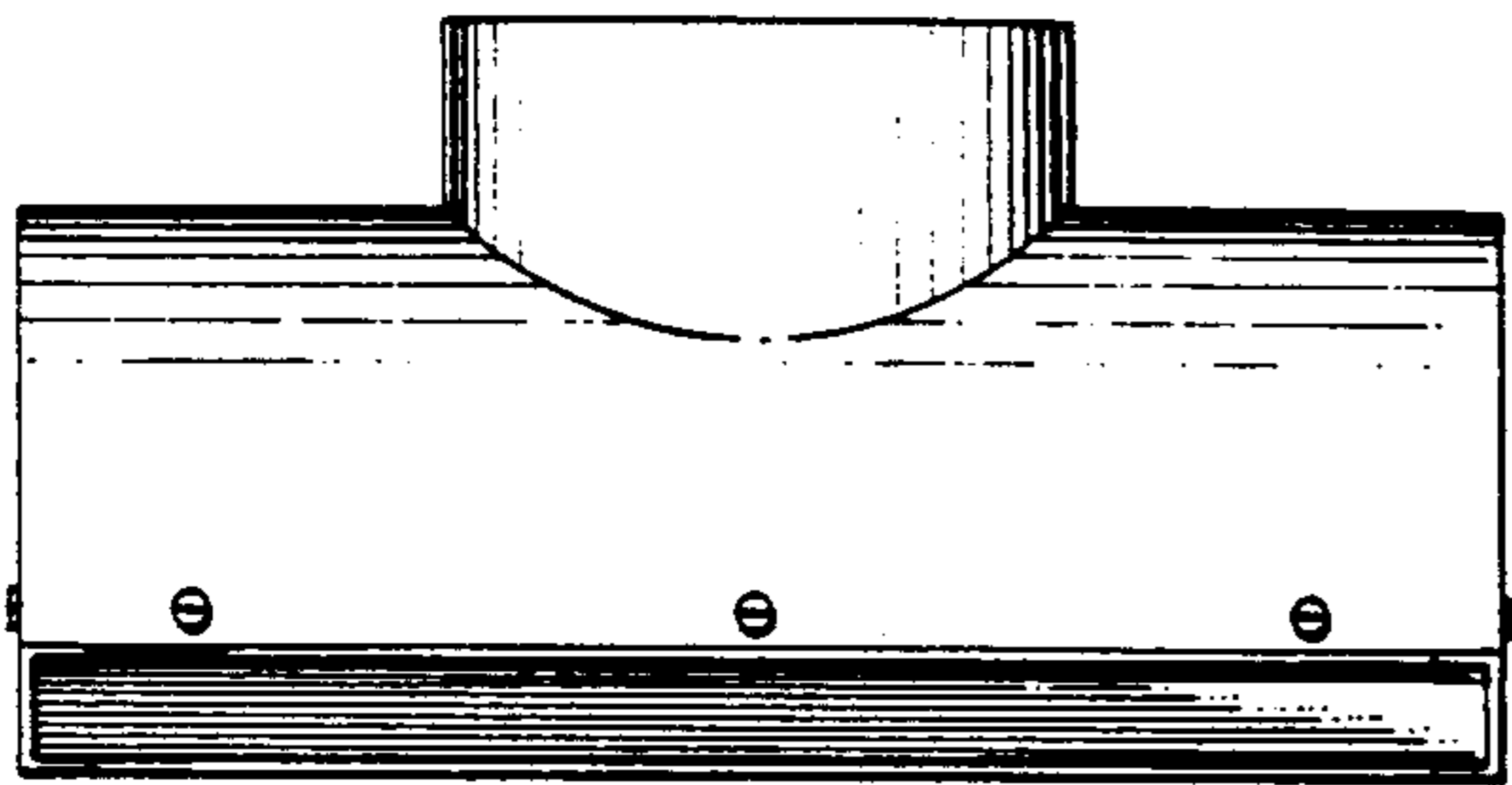

FIG-11

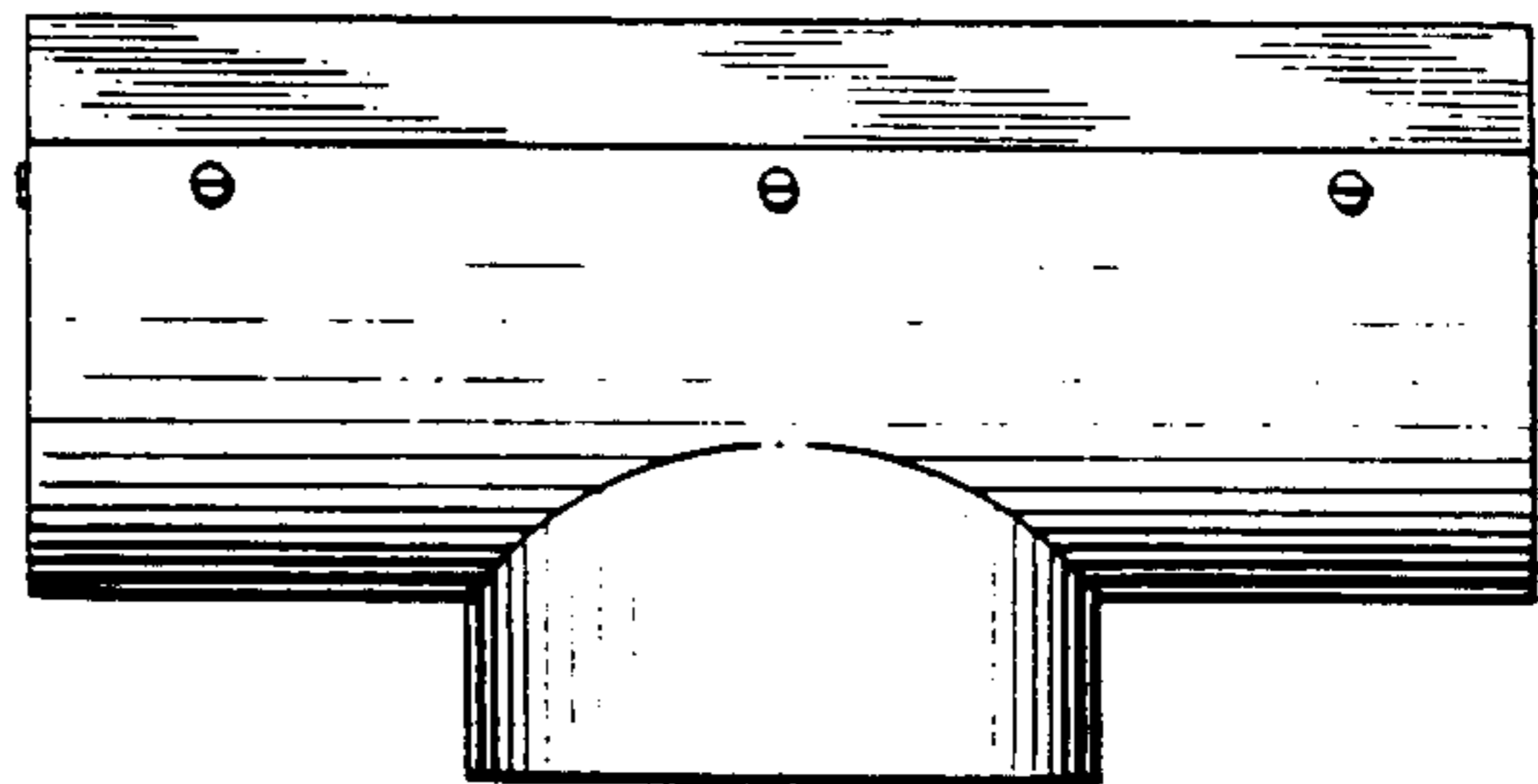

FIG-12

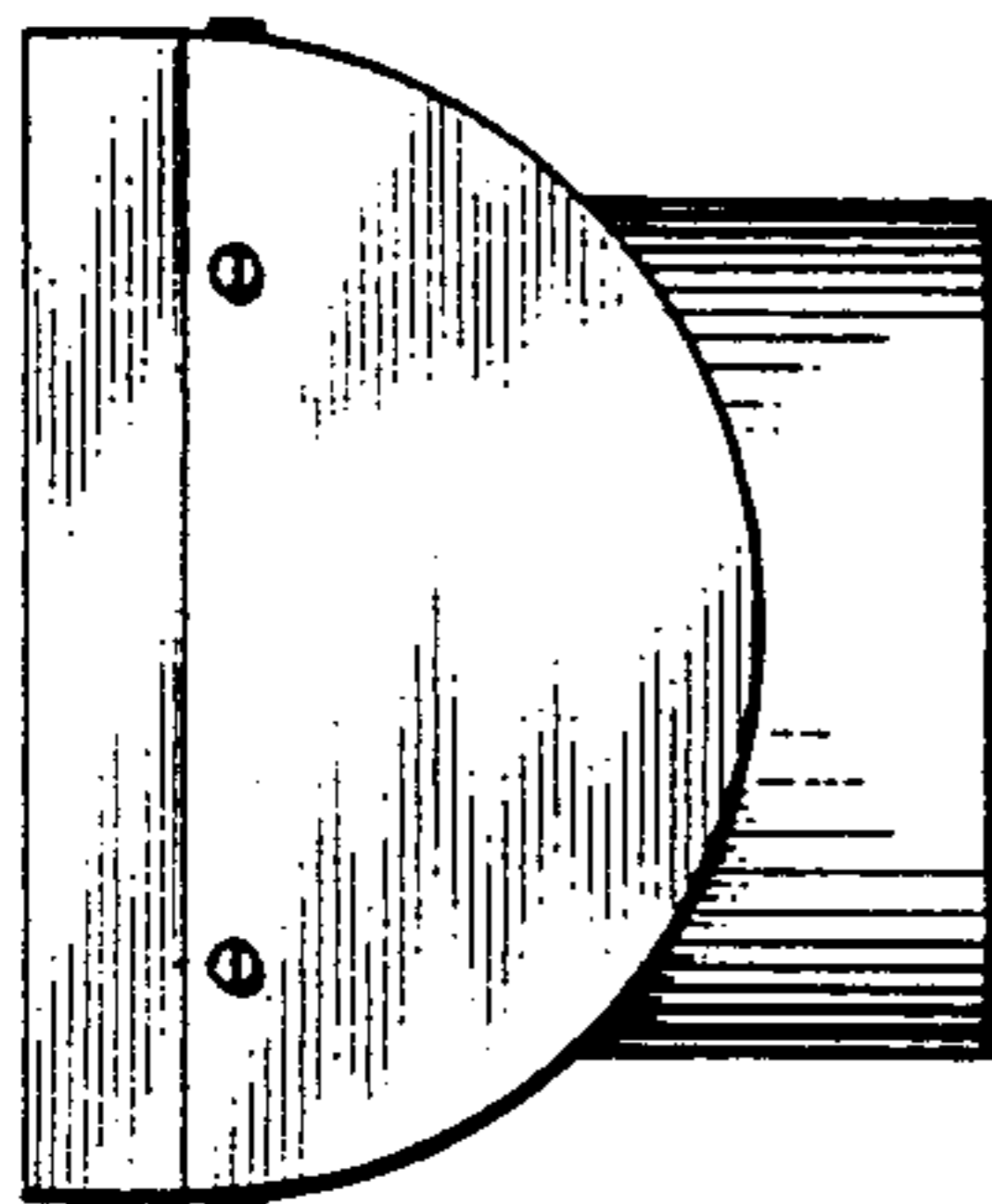

FIG-8

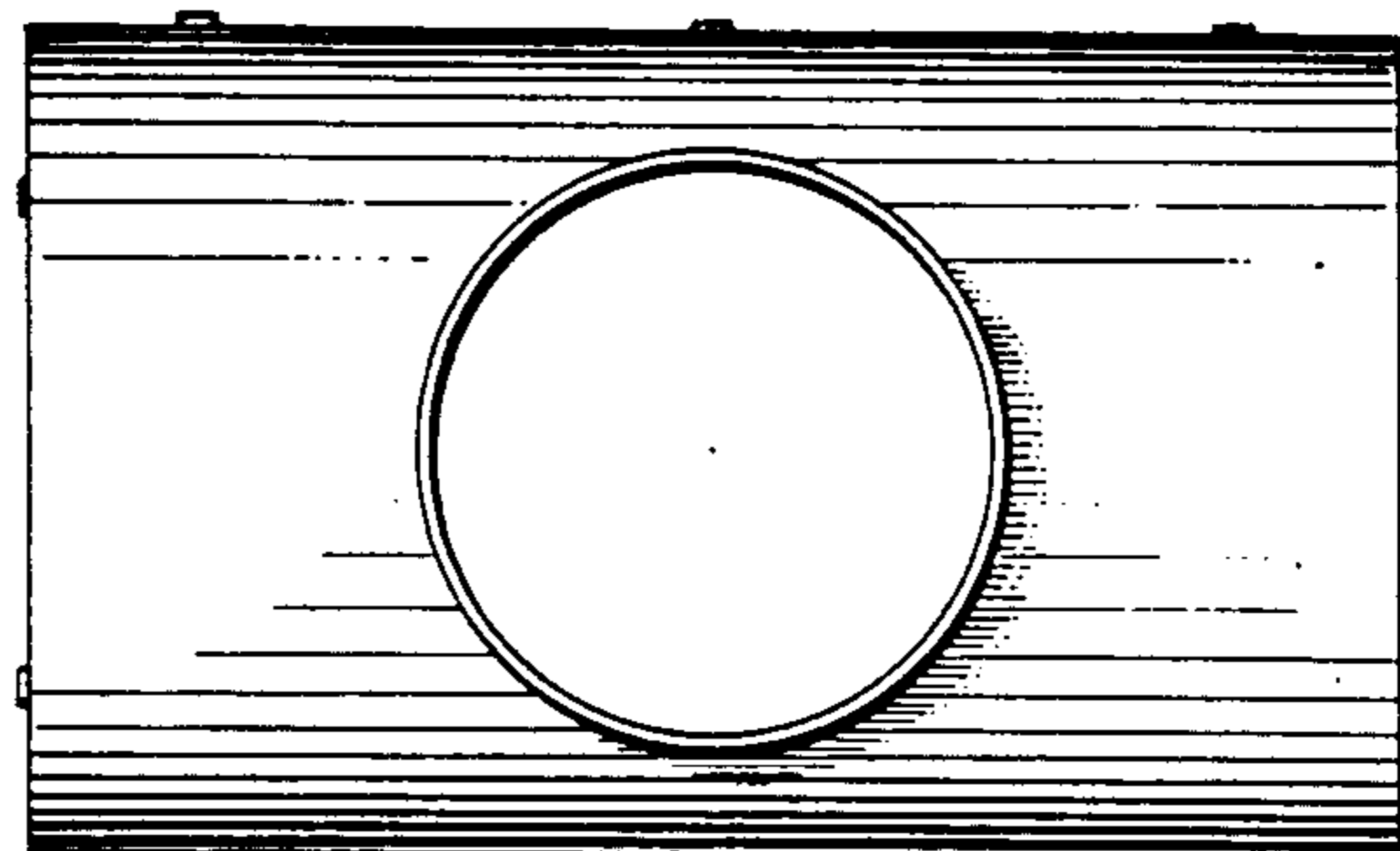

FIG-9