

[54] TELEPHONE SET

[75] Inventors: Erika Lagerbielke; Tomas Åhlman, both of Hägersten, Sweden

[73] Assignee: Swedish Telecommunications Administration, Farsta, Sweden

[\*\*] Term: 14 Years

[21] Appl. No.: 841,718

[22] Filed: Mar. 4, 1986

[30] Foreign Application Priority Data

Sep. 4, 1985 [SE] Sweden ..... M85-2063

[52] U.S. Cl. .... D14/53; D14/62; D14/63

[58] Field of Search ..... D14/53, 52, 62, 60, D14/63, 64, 56; 379/388, 433; D21/111; 446/141-143

[56] References Cited

U.S. PATENT DOCUMENTS

- D. 132,741 6/1942 Collom ..... 379/433 X
- D. 258,656 3/1981 Vaughan et al. .... D14/53 X
- D. 283,708 5/1986 Tomura ..... D14/52 X
- D. 284,003 5/1986 Tomura ..... D14/56
- D. 284,761 7/1986 Ryan ..... D14/64 X
- D. 285,068 8/1986 Haugaard ..... D14/60
- D. 285,071 8/1986 Pushelberg ..... D14/62
- 4,179,590 12/1979 Snow ..... 379/388

OTHER PUBLICATIONS

Master Telecomm Co. brochure; Model ST-5001, "Spacotel phone at p. 3: Chicago CES Show 6/1985 Box.

Metropolitan Home, Nov. 1986, at p. 124: TeleQuest "Graham Phone: Telephone Box 1986.

Primary Examiner—Wallace R. Burke  
Assistant Examiner—Horace B. Fay  
Attorney, Agent, or Firm—Pollock, Vande Sande & Priddy

CLAIM

[57] The ornamental design for a telephone set, as shown and described.

DESCRIPTION

FIG. 1 is a left side, top and front perspective view of a telephone set showing our new design;

FIG. 2 is a right side partial top and rear perspective view thereof;

FIG. 3 is a top and front perspective view thereof;

FIG. 4 is a left side, top and front perspective view of the stand of the set shown alone for clarity of illustration;

FIG. 5 is a top and right side perspective view of the handset receiver of the set shown alone for clarity of illustration; and

FIG. 6 is a bottom perspective view.

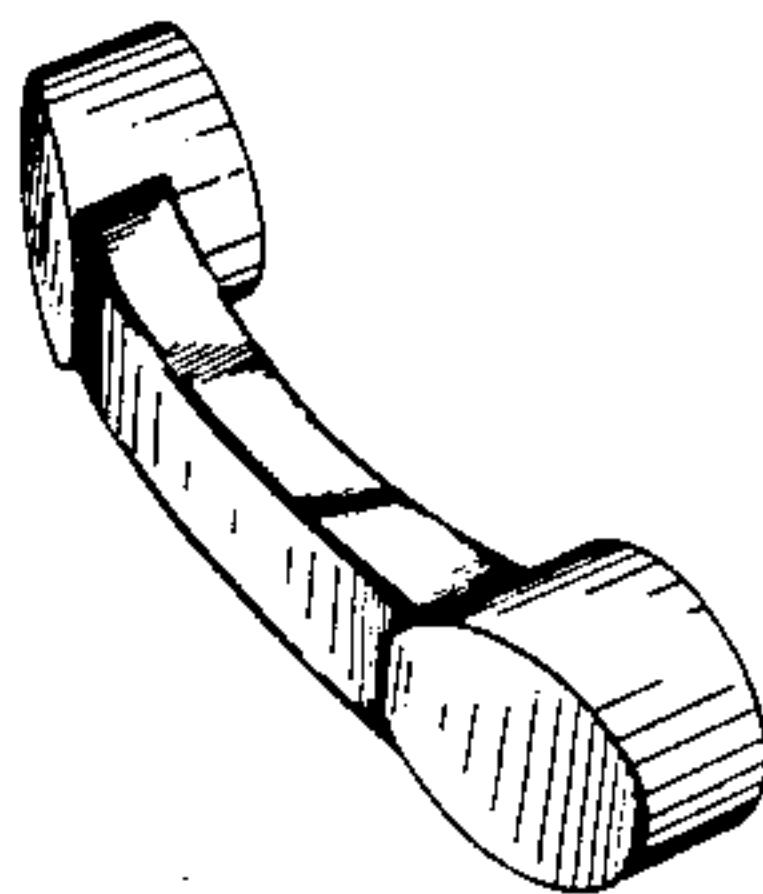
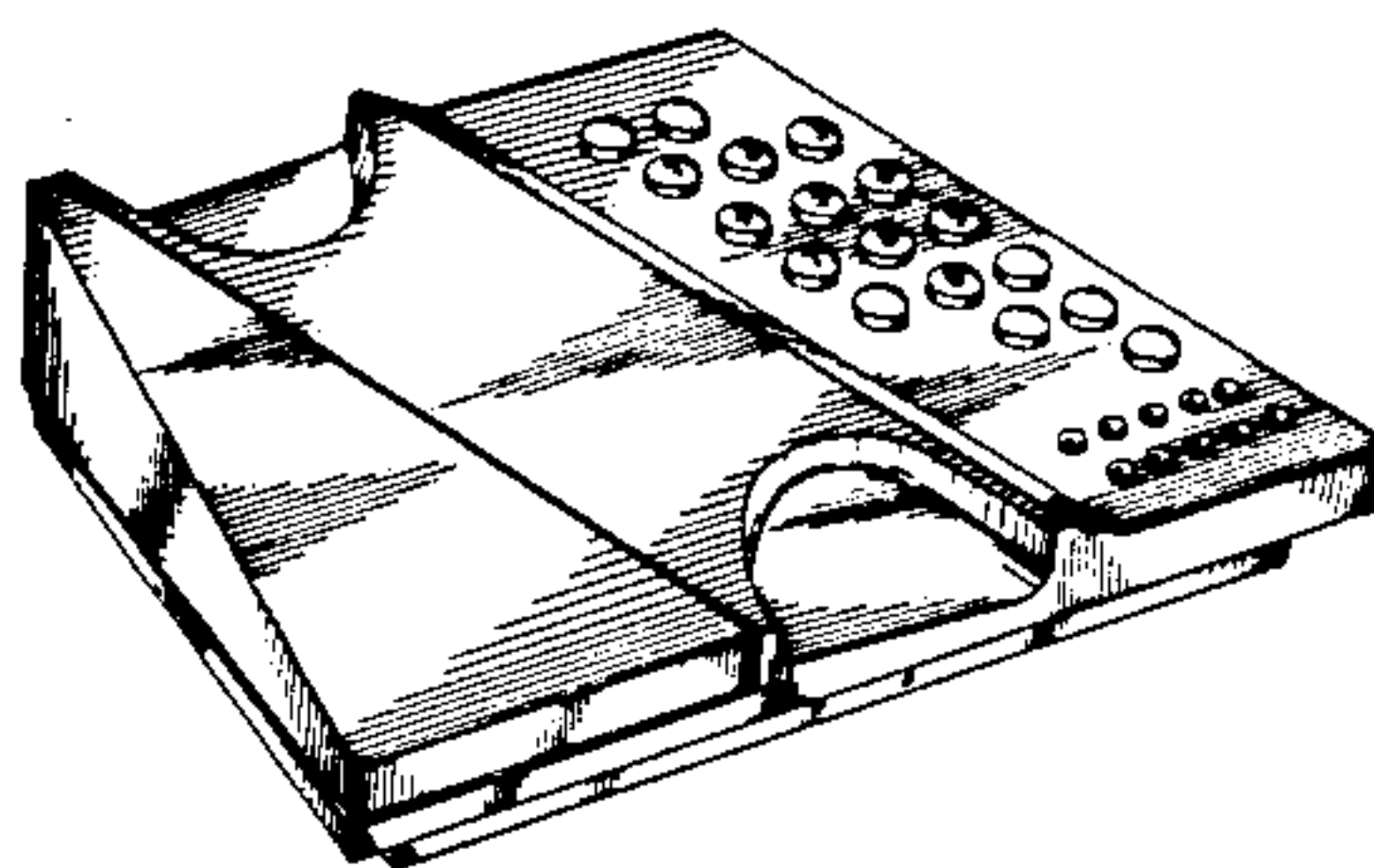

Fig. 1

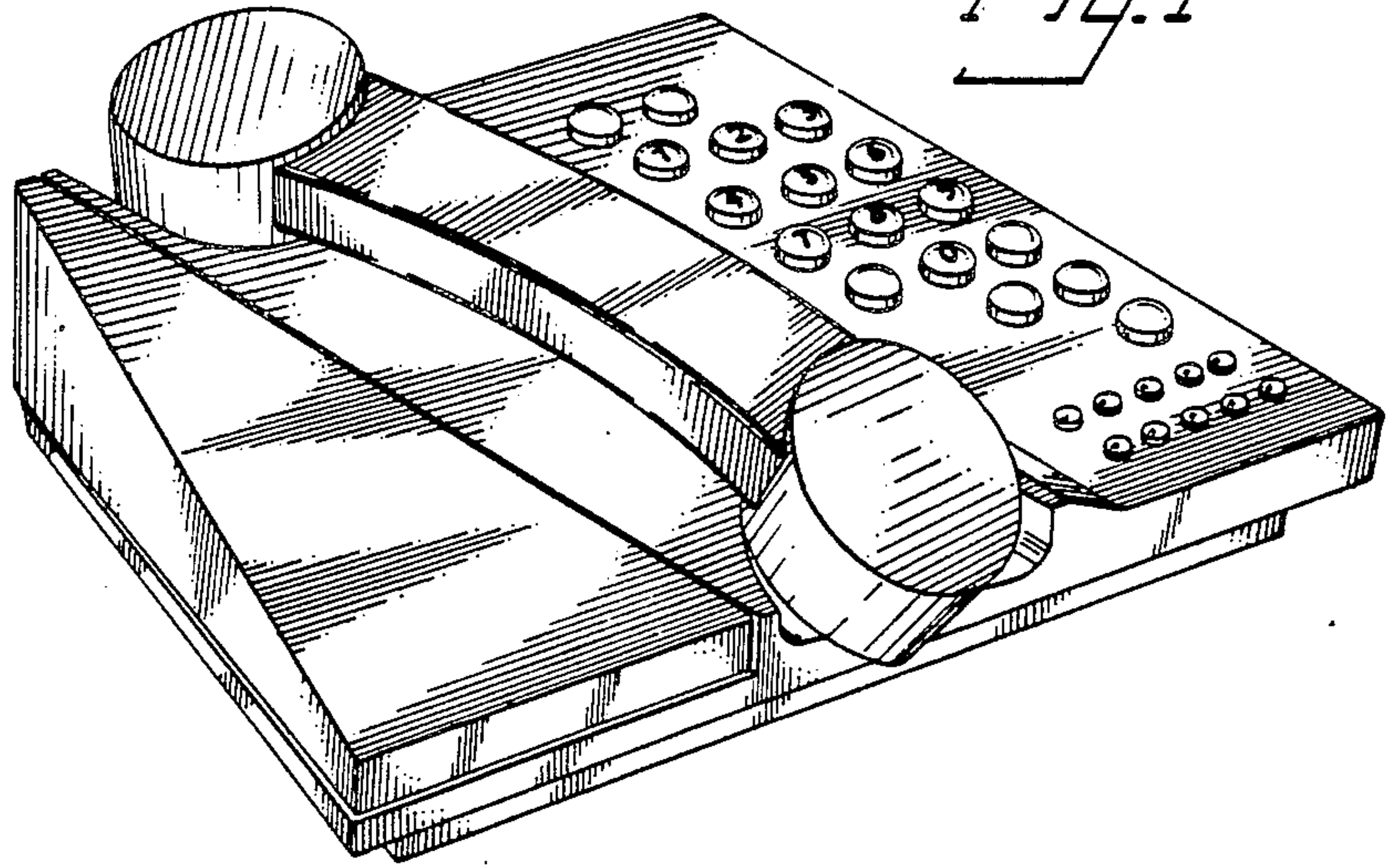

Fig. 2

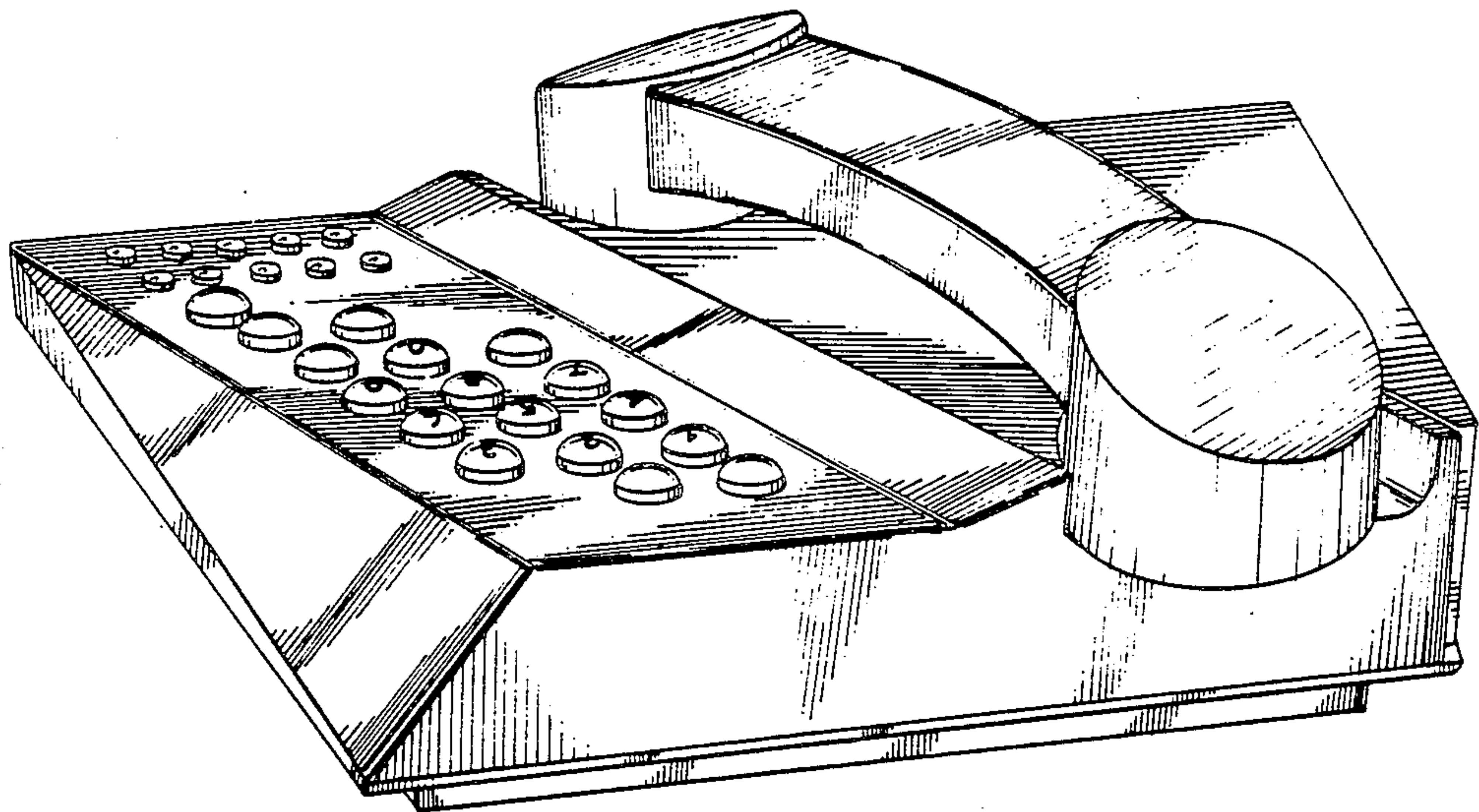

Fig. 3

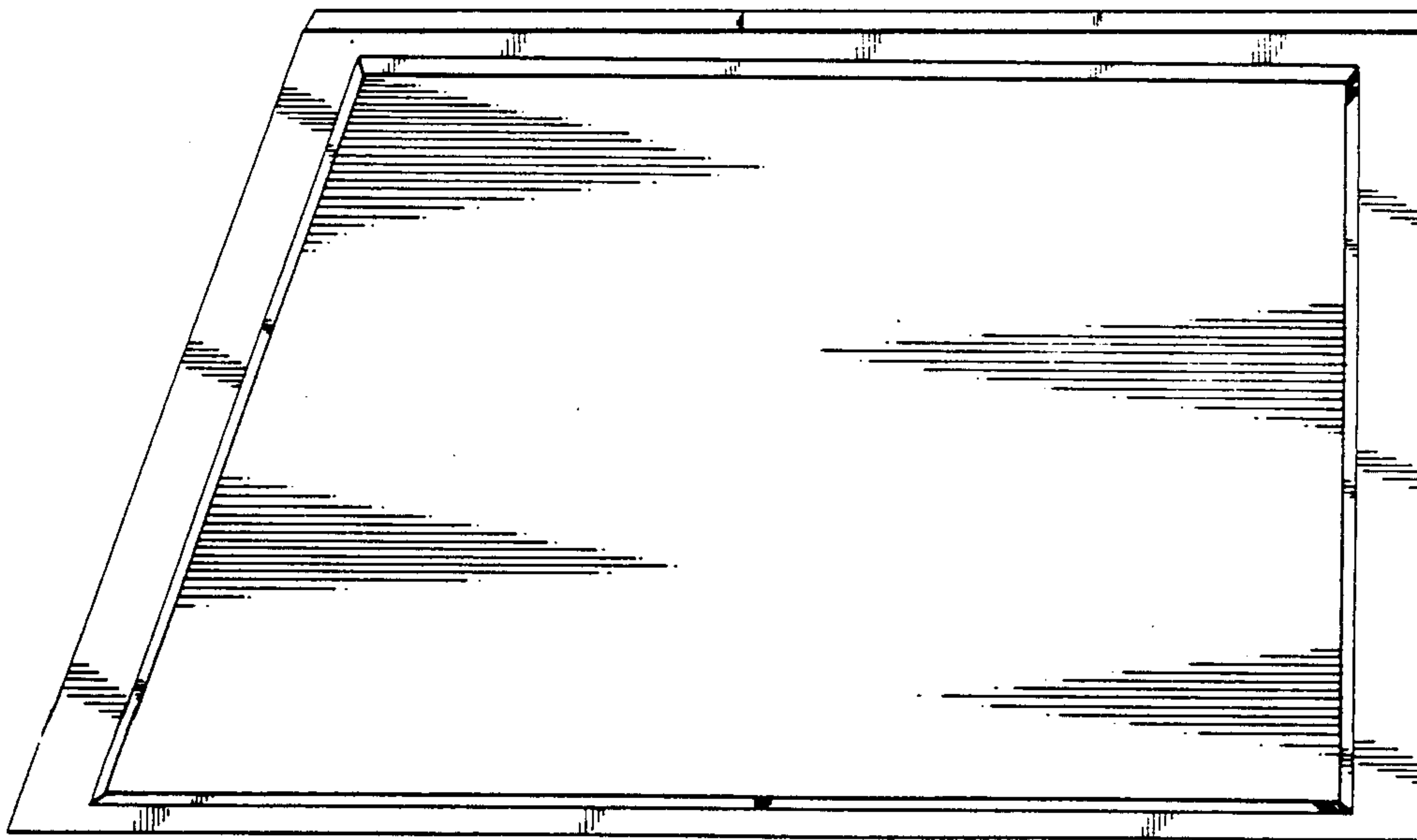
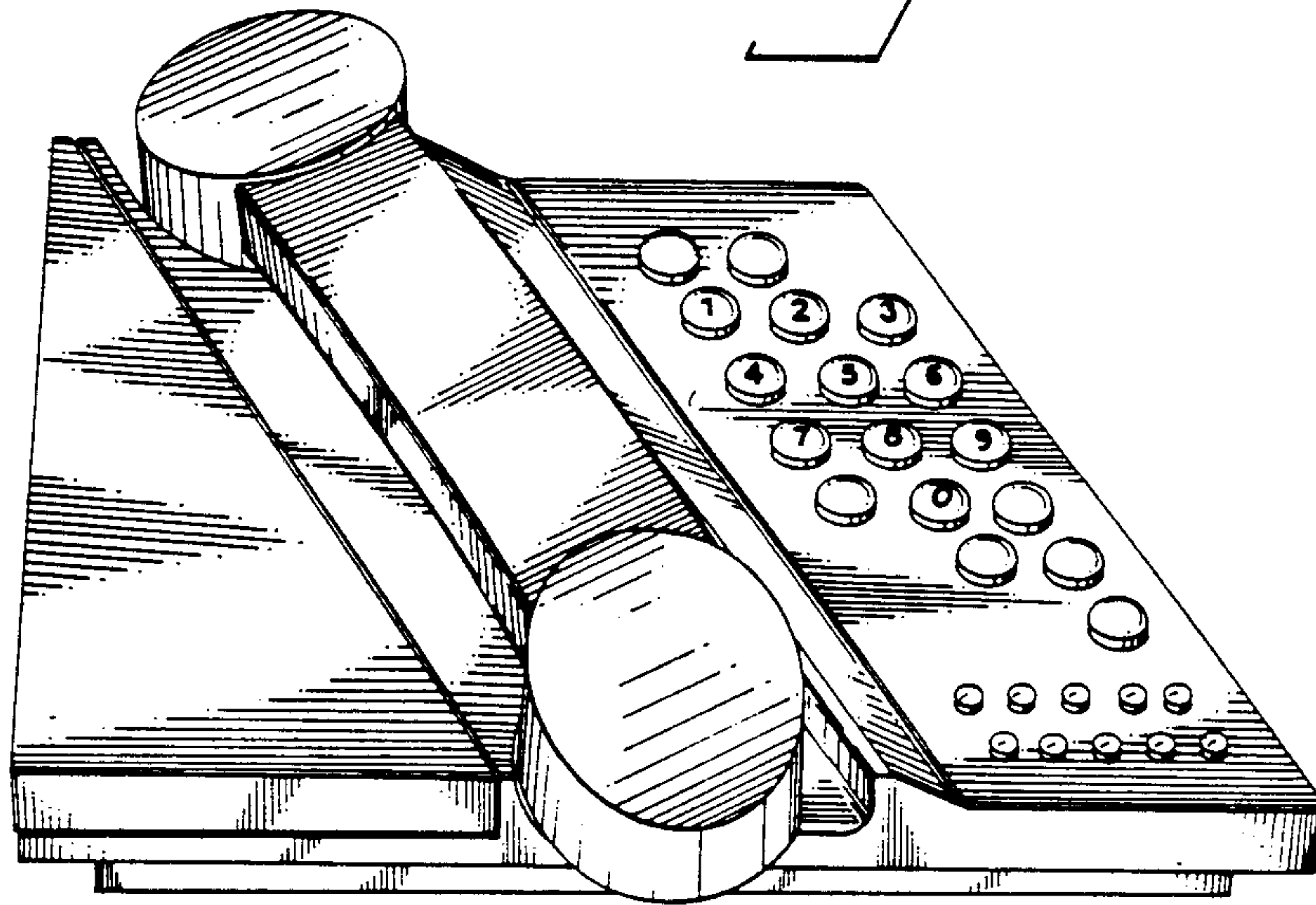

Fig. 6



Fig. 4

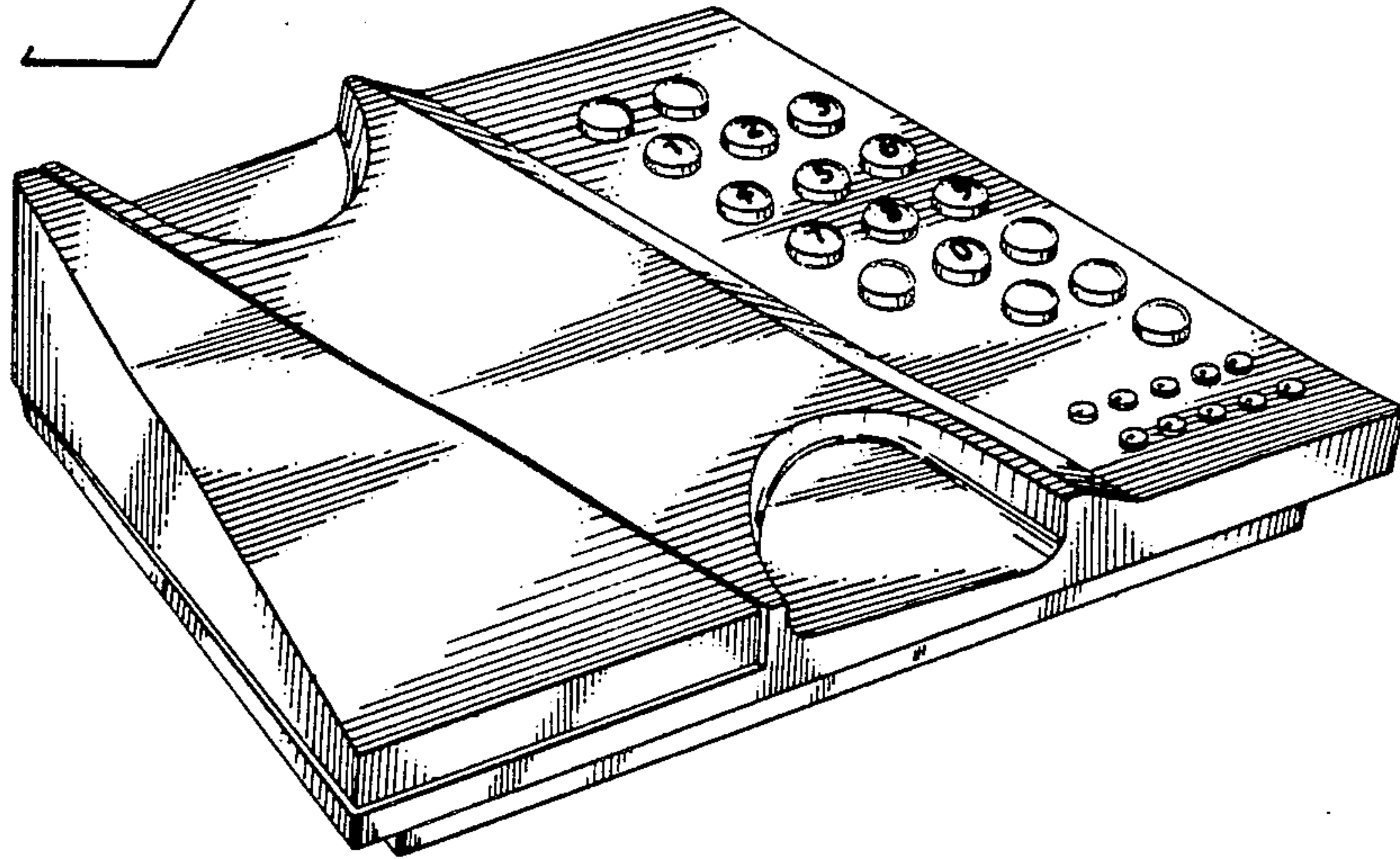

Fig. 5

