

**United States Patent** [19]  
**Cheng**

[11] **Patent Number: Des. 292,868**

[45] **Date of Patent: \*\* Nov. 24, 1987**

[54] **COMBINATION LOCK**

[76] **Inventor: Ching-Yuan Cheng, 64-5, Alley 70,  
Lane 419, Pei Tun Rd., Taichung,  
Taiwan**

[\*\*] **Term: 14 Years**

[21] **Appl. No.: 806,604**

[22] **Filed: Dec. 9, 1985**

[52] **U.S. Cl. .... D8/331**

[58] **Field of Search .... D8/330-331,  
D8/339, 341, 336, 338; 70/63-64, 67, 69, 75,  
286-288, 291, 298, 301, 304, 312, 315-316, 318,  
330, 332**

[56] **References Cited**

**U.S. PATENT DOCUMENTS**

D. 253,747 12/1979 Stolarz ..... D8/338

D. 274,305 6/1984 Gisiger ..... D8/338  
D. 281,948 12/1985 Hesse ..... D8/338

*Primary Examiner*—Wallace R. Burke  
*Assistant Examiner*—Brian N. Vinson  
*Attorney, Agent, or Firm*—Holman & Stern

[57] **CLAIM**

The ornamental design for a combination lock, as shown.

**DESCRIPTION**

FIG. 1 is a top perspective view of a combination lock showing my new design;  
FIG. 2 is a front elevational view thereof;  
FIG. 3 is a top plan view thereof;  
FIG. 4 is a rear elevational view thereof;  
FIG. 5 is a bottom plan view thereof;  
FIG. 6 is a left side elevational view thereof; and  
FIG. 7 is a right side elevational view thereof.

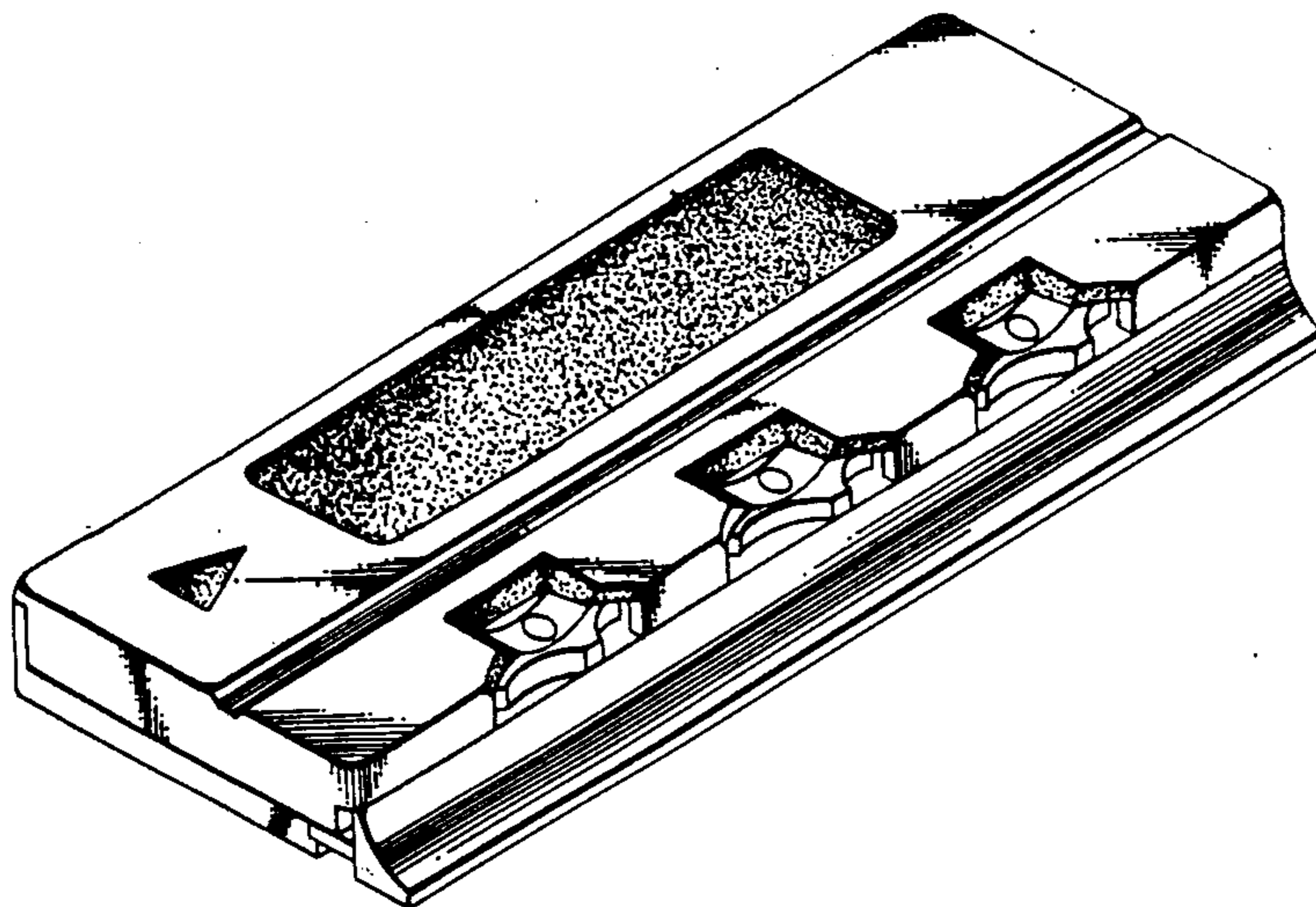

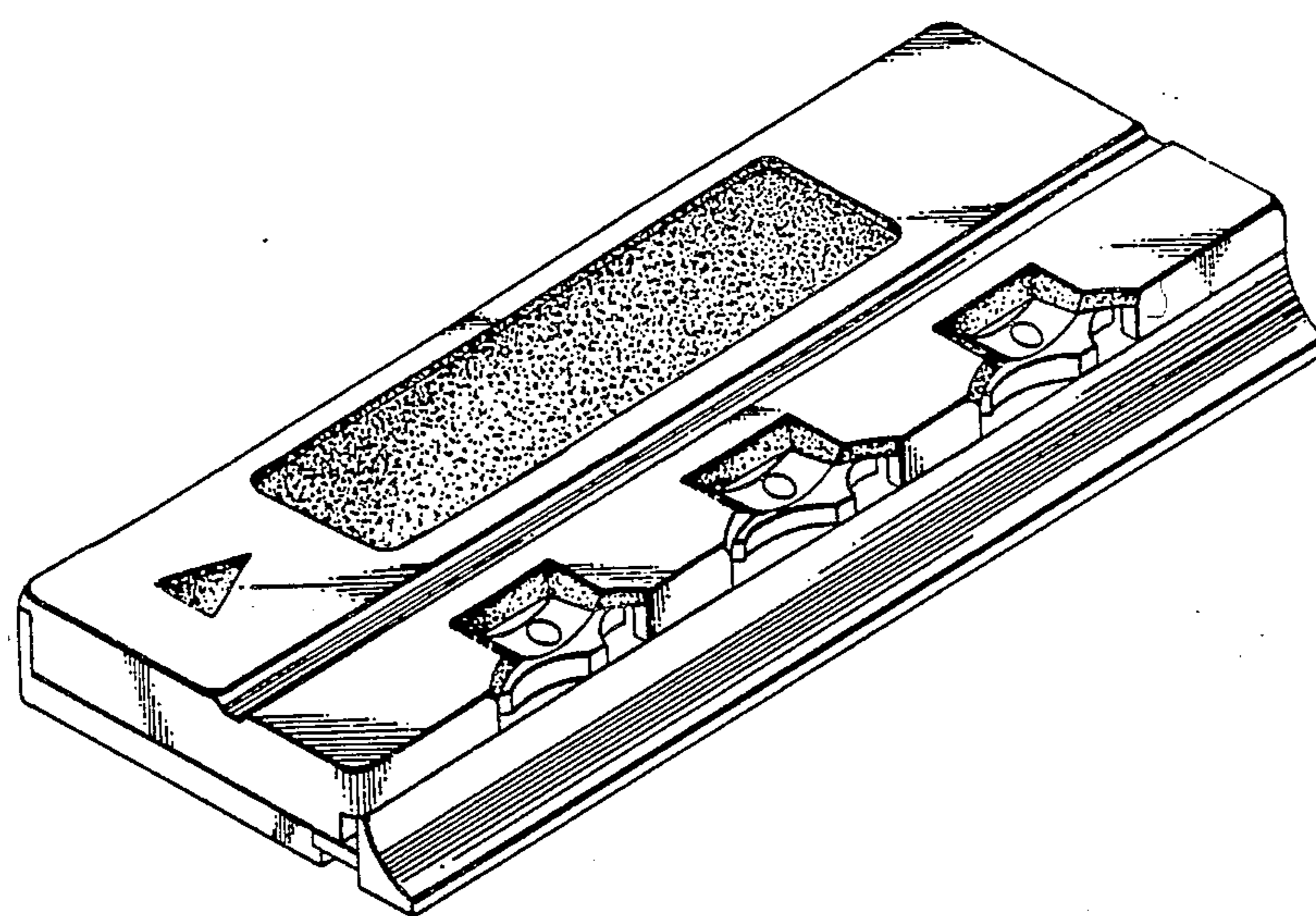

FIG. 1

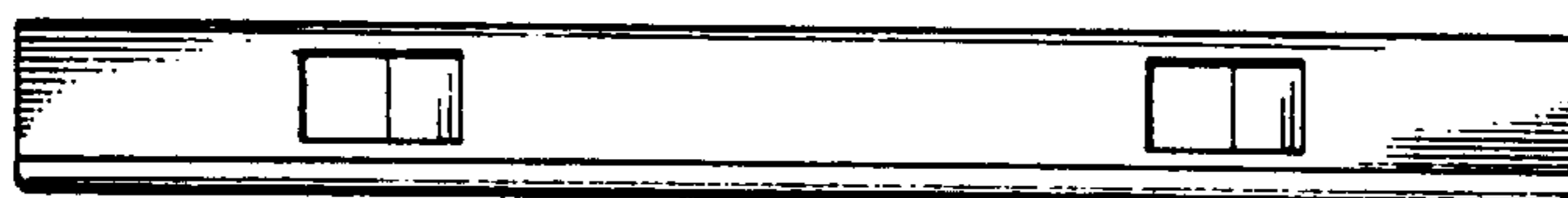

FIG. 4

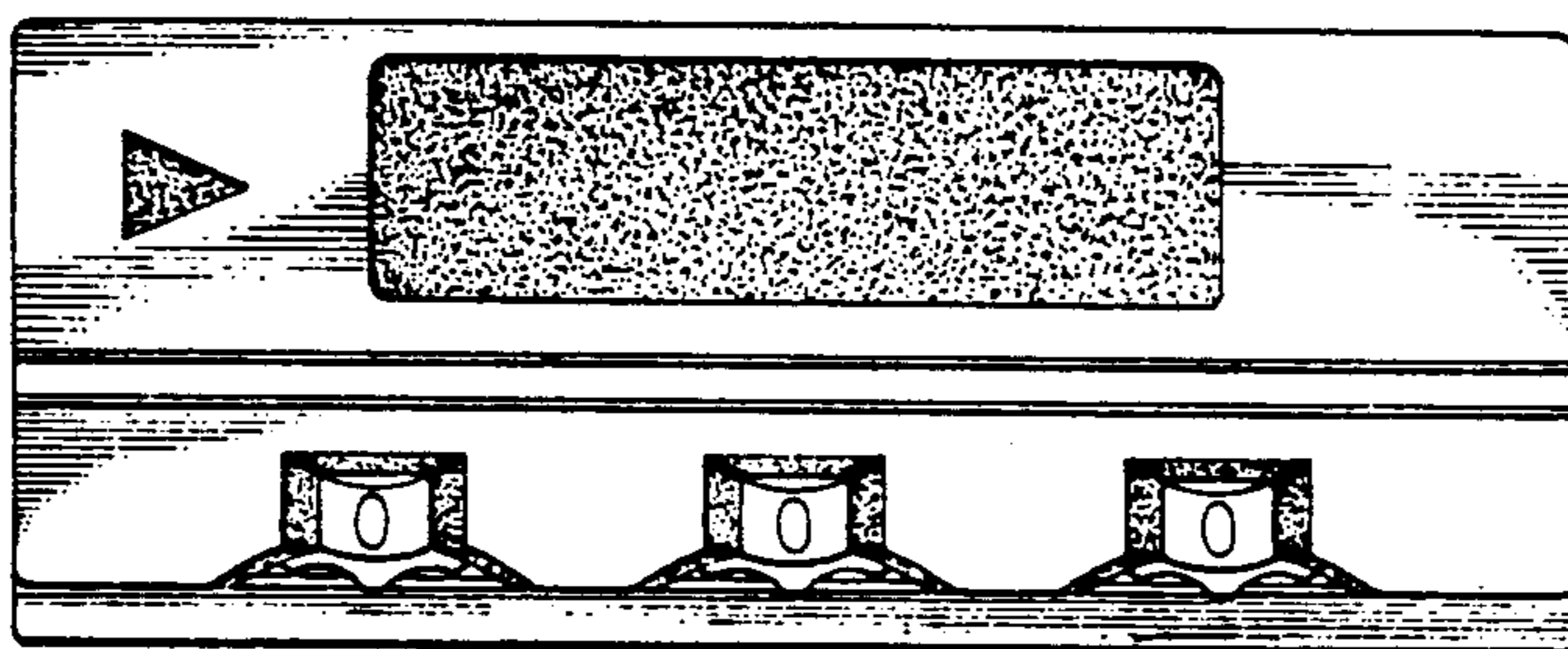

FIG. 3



FIG. 2

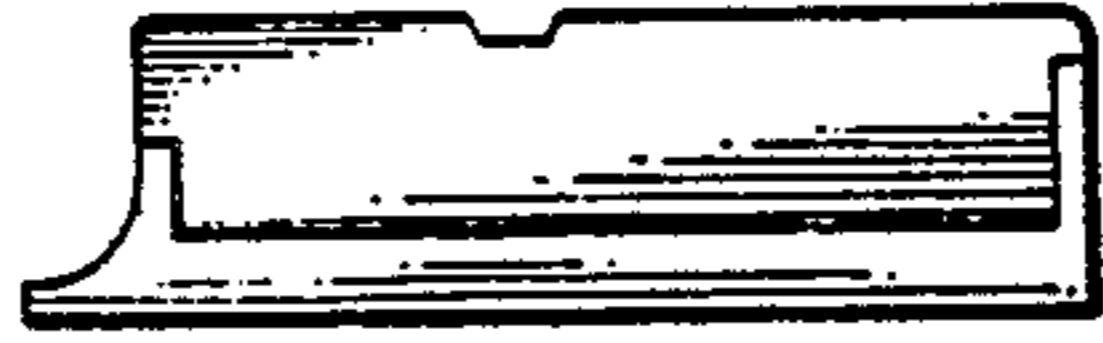

FIG. 7

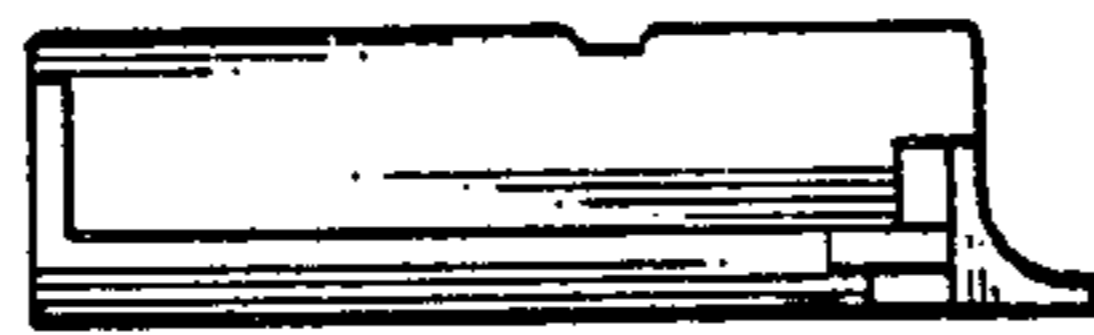

FIG. 6

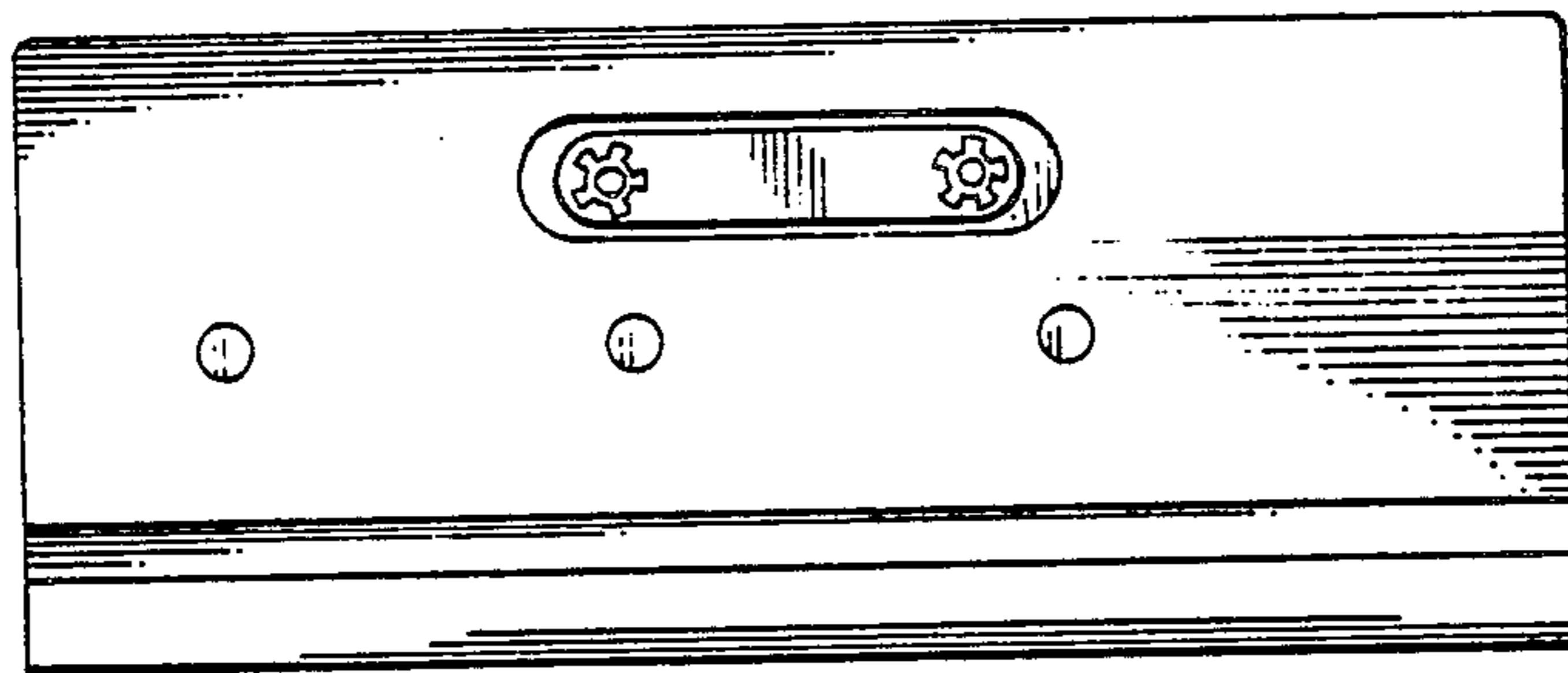

FIG. 5