

[54] COMBINATION STAPLE REMOVER AND TAPE CUTTER

[76] Inventor: William A. Skewis, 171 W. Spruce St., Sequim, Wash. 98382

[**] Term: 14 Years

[21] Appl. No.: 710,297

[22] Filed: Mar. 11, 1985

[52] U.S. Cl. D8/48; D8/89

[58] Field of Search D8/48, 88, 89; 254/28; 227/63

[56] References Cited

U.S. PATENT DOCUMENTS

D. 137,939	5/1944	Polzer	D8/48
1,973,846	9/1934	Crofoot	254/28
2,563,227	8/1951	Emery	254/28
3,698,689	10/1972	Poskin	254/28
4,049,236	9/1977	Grill et al.	254/28

FOREIGN PATENT DOCUMENTS

231984 12/1960 Australia .

Primary Examiner—Bernard Ansher
Assistant Examiner—Terry Pfeffer
Attorney, Agent, or Firm—Eugene M. Eckelman

[57] CLAIM

The ornamental design for a combination staple remover and tape cutter, as shown and described.

DESCRIPTION

FIG. 1 is a top, front, left side perspective view of a combination staple remover and tape cutter showing my new design;

FIG. 2 is a left side elevational view thereof, the opposite side being a mirror image;

FIG. 3 is a top plan view thereof;

FIG. 4 is a bottom plan view thereof;

FIG. 5 is a front elevational view thereof; and

FIG. 6 is a rear elevational view thereof.

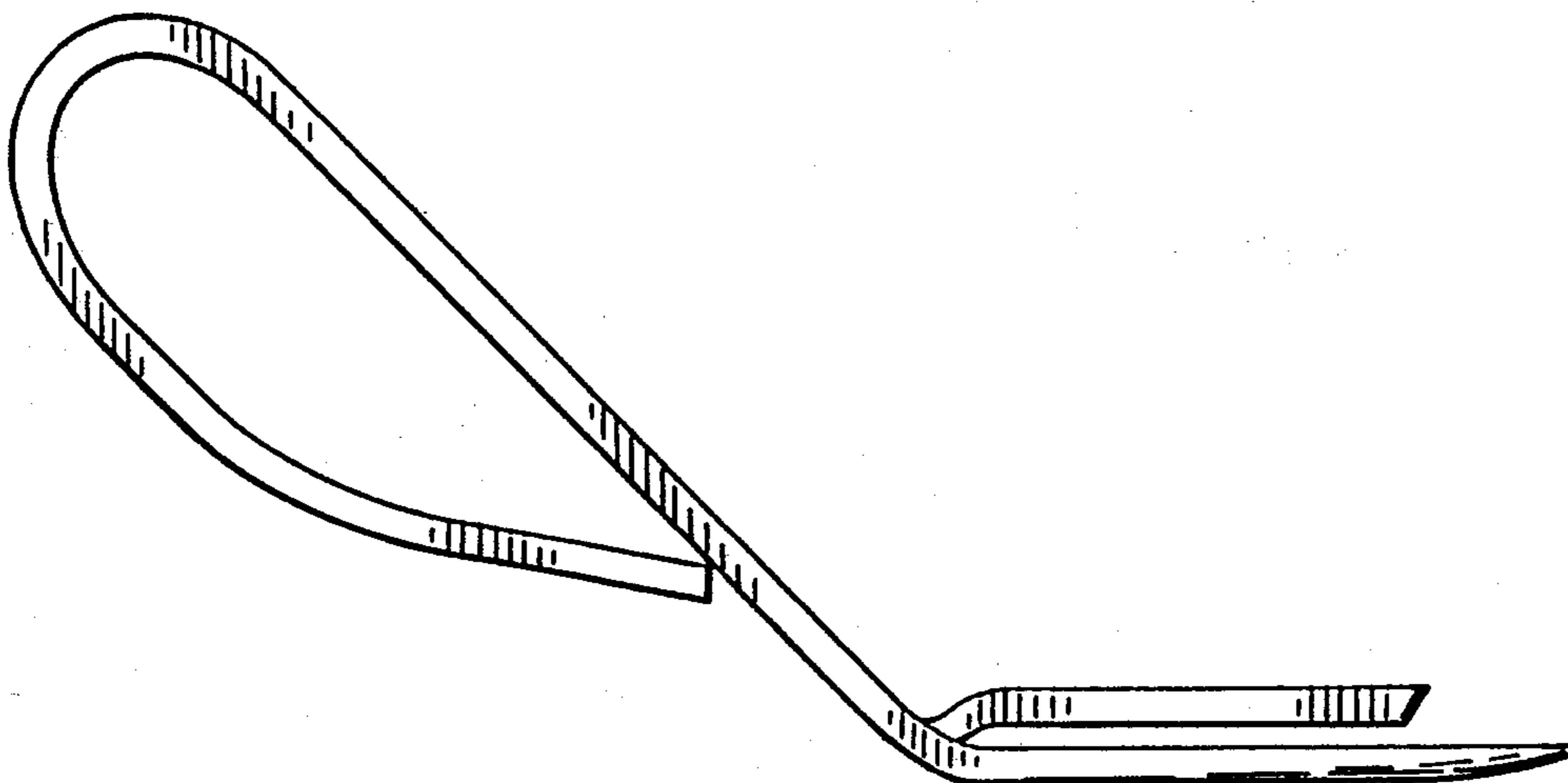
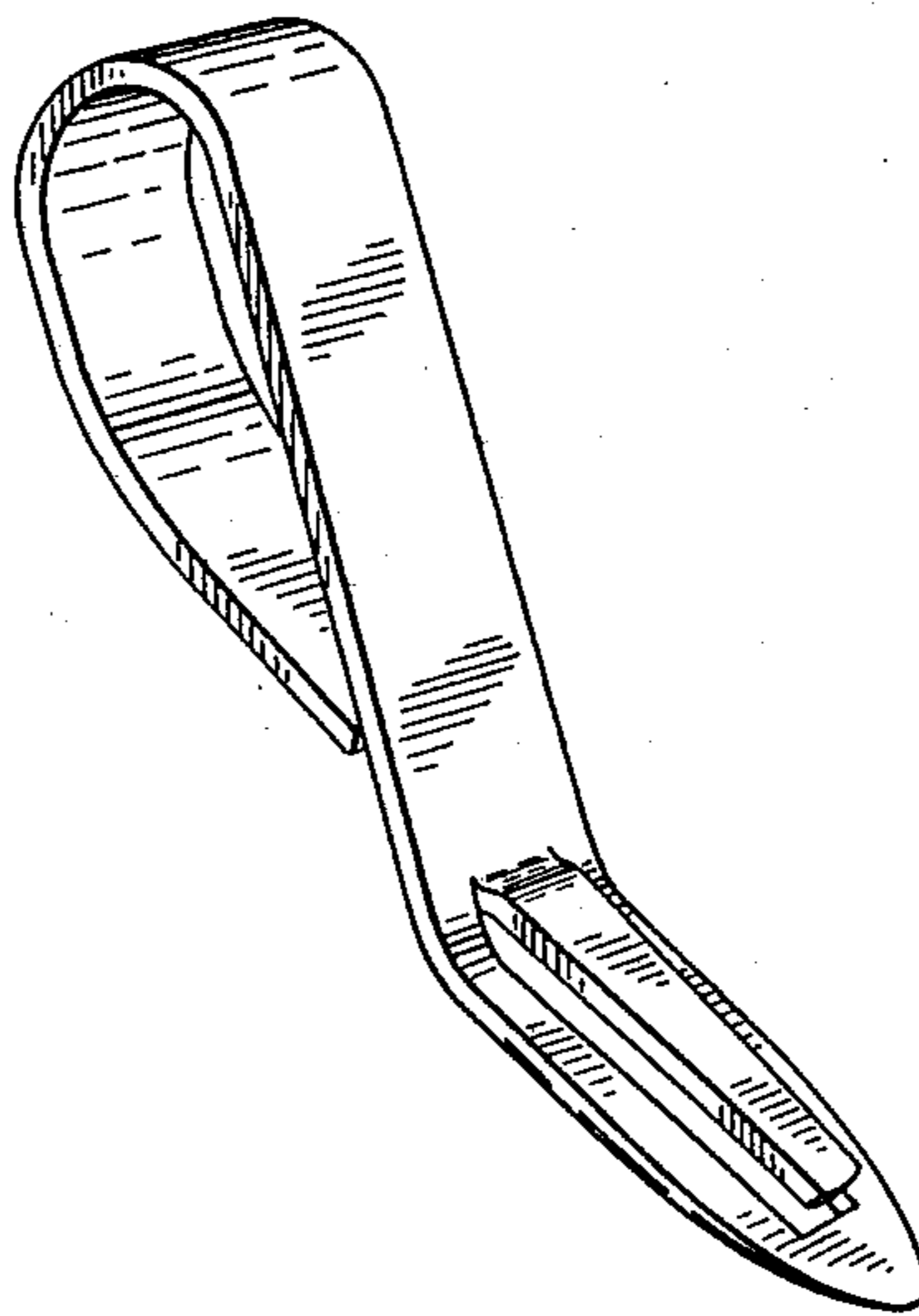

FIG. 6

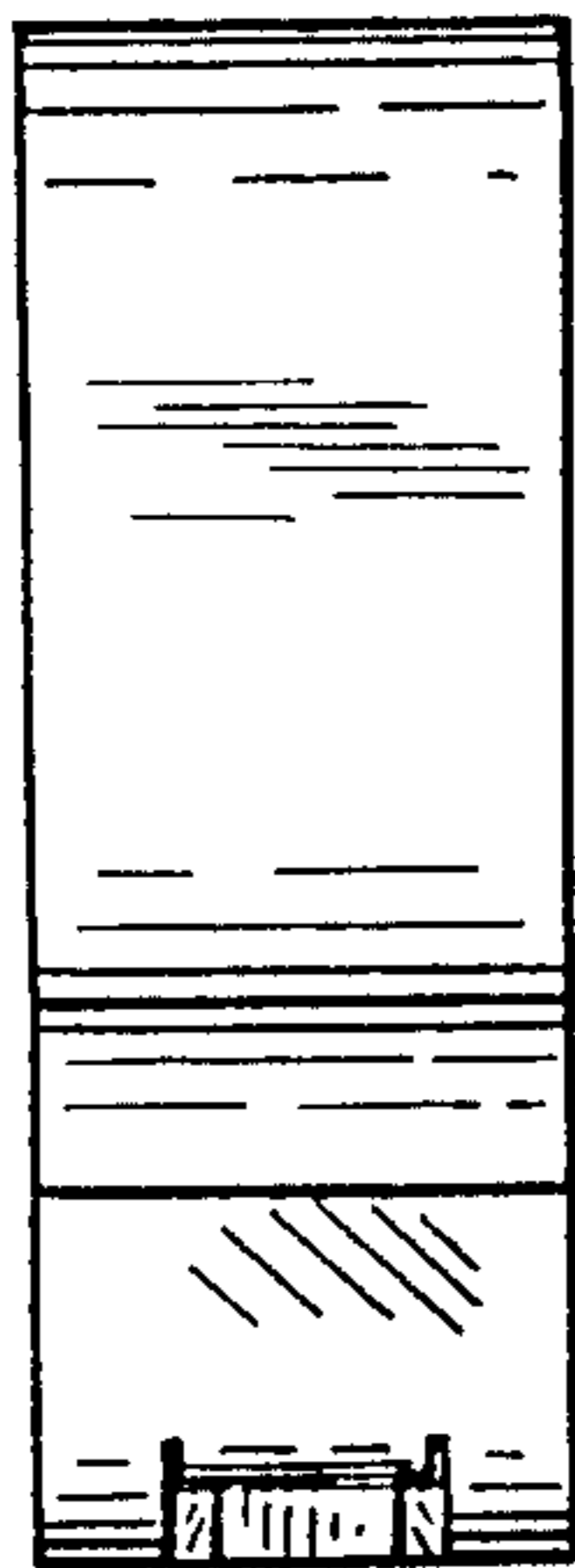

FIG. 1

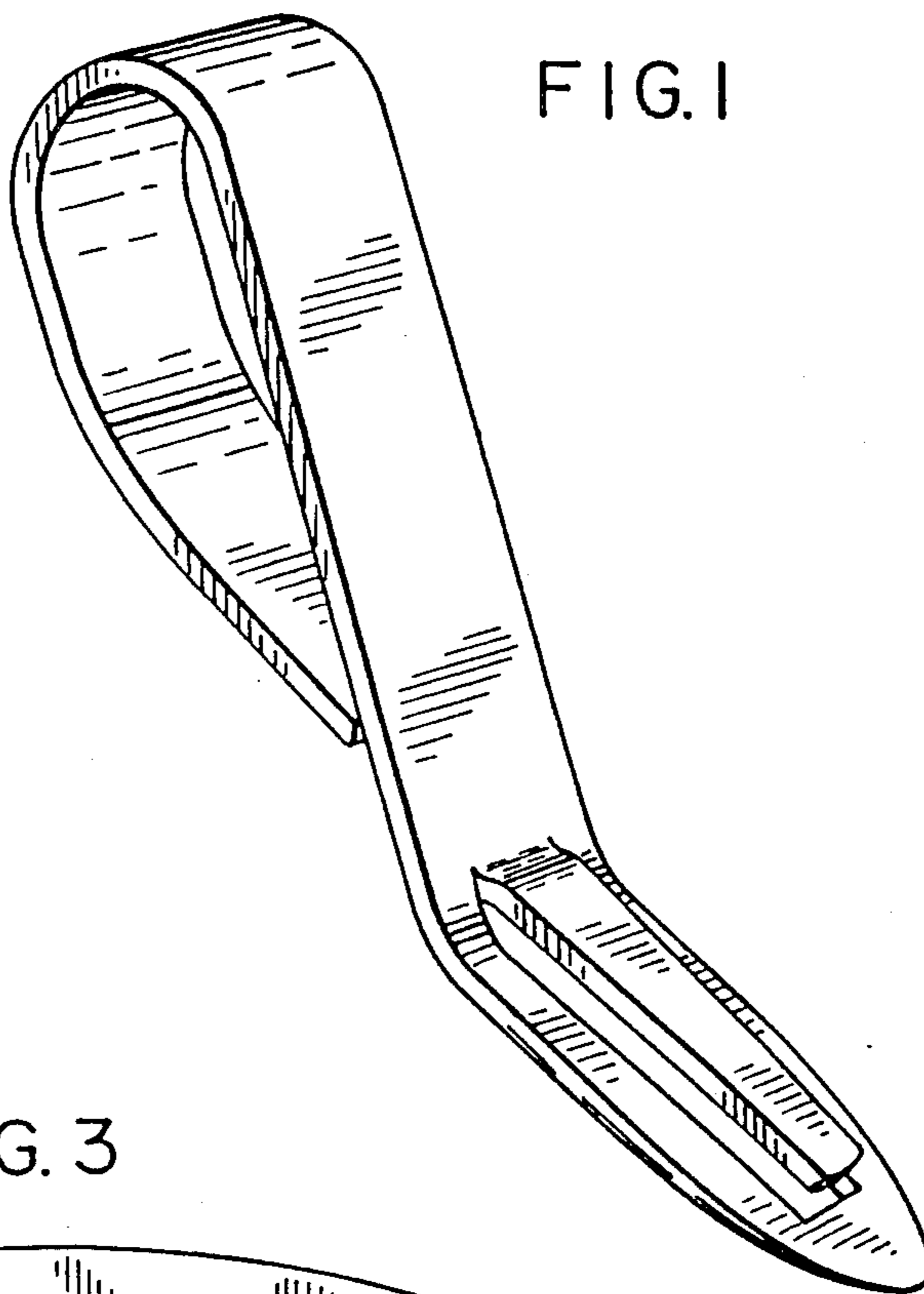

FIG. 3

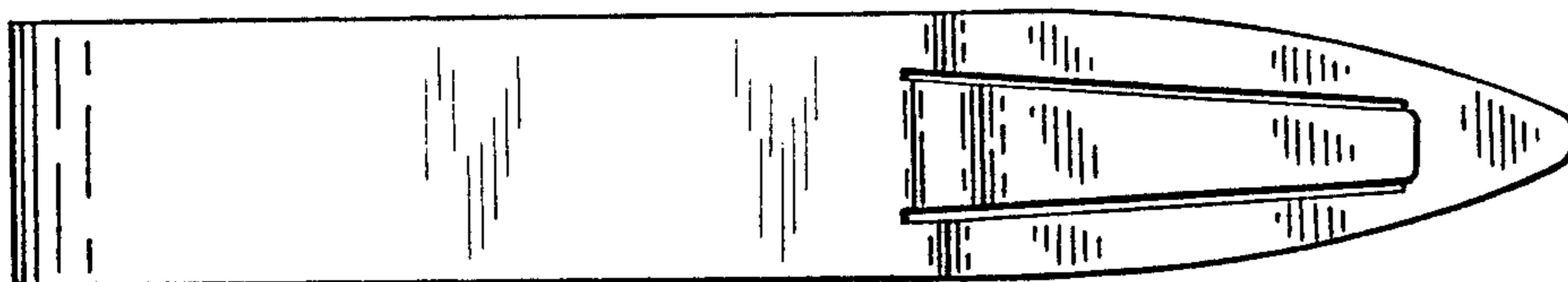

FIG. 2

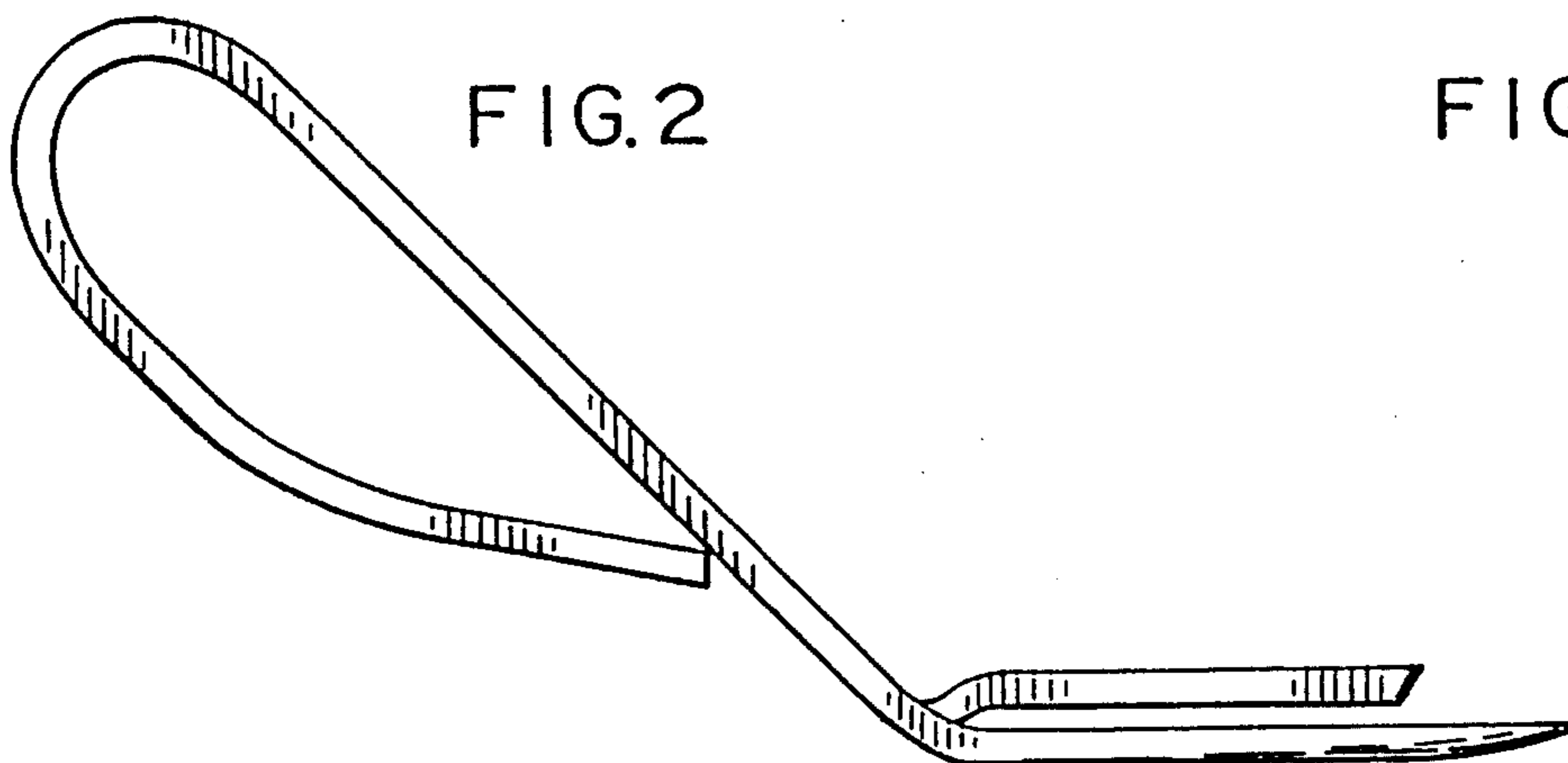

FIG. 5

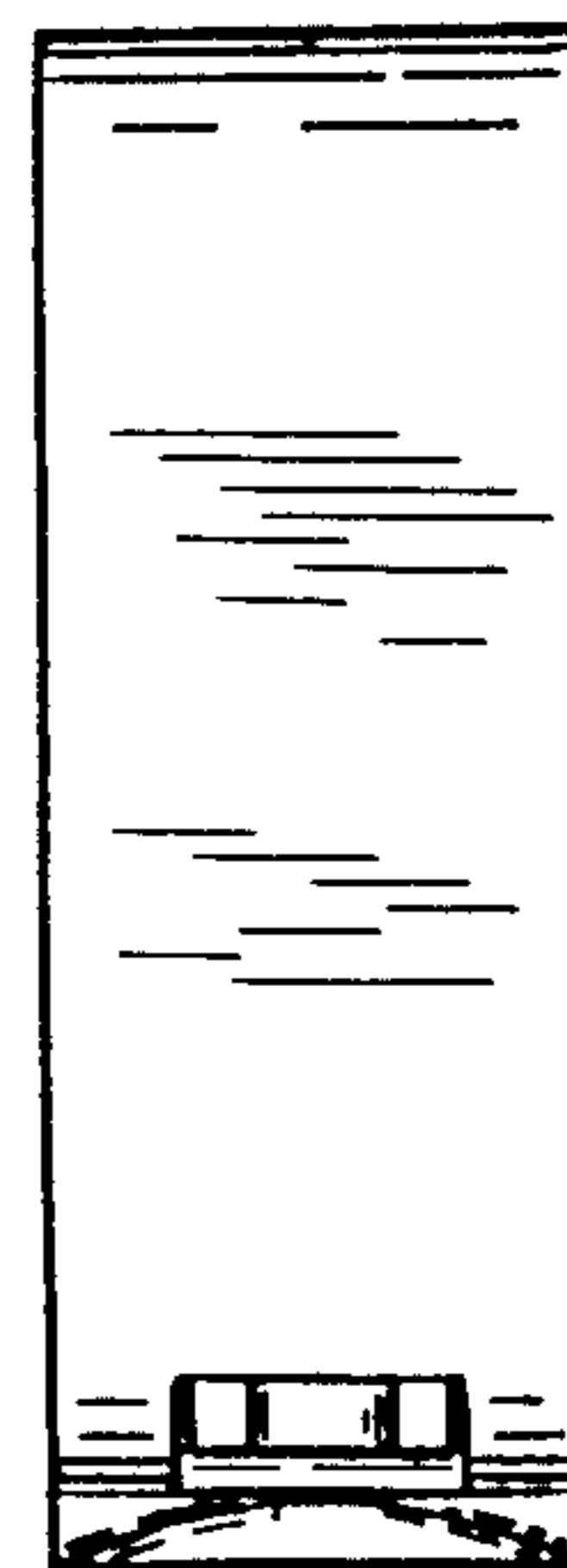

FIG. 4

