

[54] MOBILE MUSIC AND RECORDING STORAGE UNIT

[75] Inventors: William E. Dewart, Whitemarsh; David S. Lovitz, Philadelphia, both of Pa.

[73] Assignee: Durland & Associates, Ltd., Whitemarsh, Pa.

[**] Term: 14 Years

[21] Appl. No.: 690,260

[22] Filed: Jan. 10, 1985

[52] U.S. Cl. D6/445; D6/467; D14/99

[58] Field of Search D14/1-7, D14/68, 67, 85, 95, 99, 96; D6/445, 432, 467; 369/1, 10, 12; 312/114

[56] References Cited

U.S. PATENT DOCUMENTS

- D. 250,707 1/1979 Pulos et al. D14/1
- D. 269,480 6/1983 Peterson et al. D14/96 X
- D. 278,058 3/1985 Larson D14/68
- D. 279,724 7/1985 Stacy D6/445 X
- 3,347,607 10/1967 Knize 369/12 X

Primary Examiner—Bernard Ansher
Assistant Examiner—Theodore M. Shooman
Attorney, Agent, or Firm—Steele, Gould & Fried

[57] CLAIM

The ornamental design for a mobile music and recording storage unit, as shown and described.

DESCRIPTION

FIG. 1 is a top, front and left side perspective view of a mobile music and recording storage unit showing our new design;

FIG. 2 is a front elevational view thereof;

FIG. 3 is a rear elevational view thereof;

FIG. 4 is a top plan view thereof;

FIG. 5 is a left side elevational view thereof; and

FIG. 6 is a right side elevational view thereof.

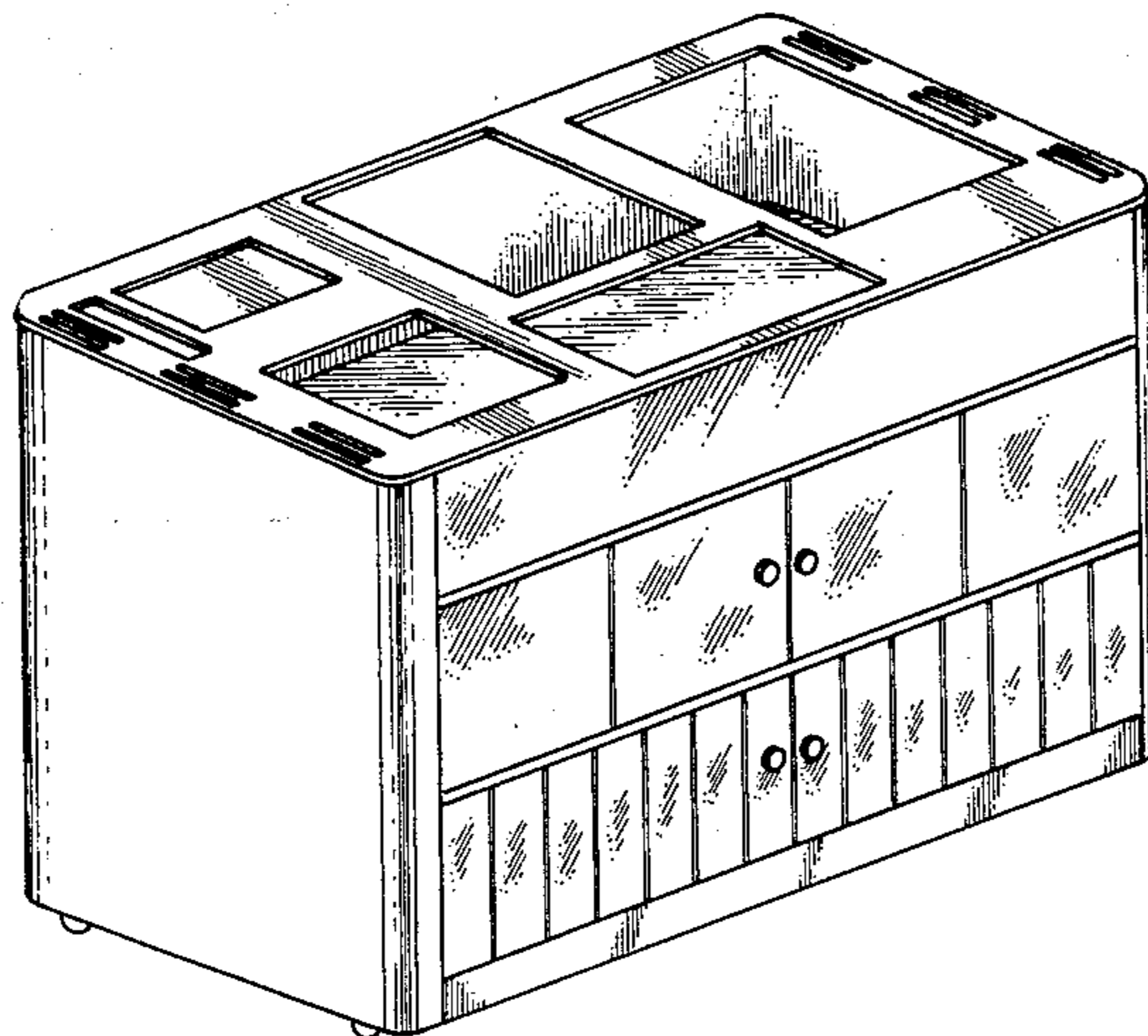

FIG. 1

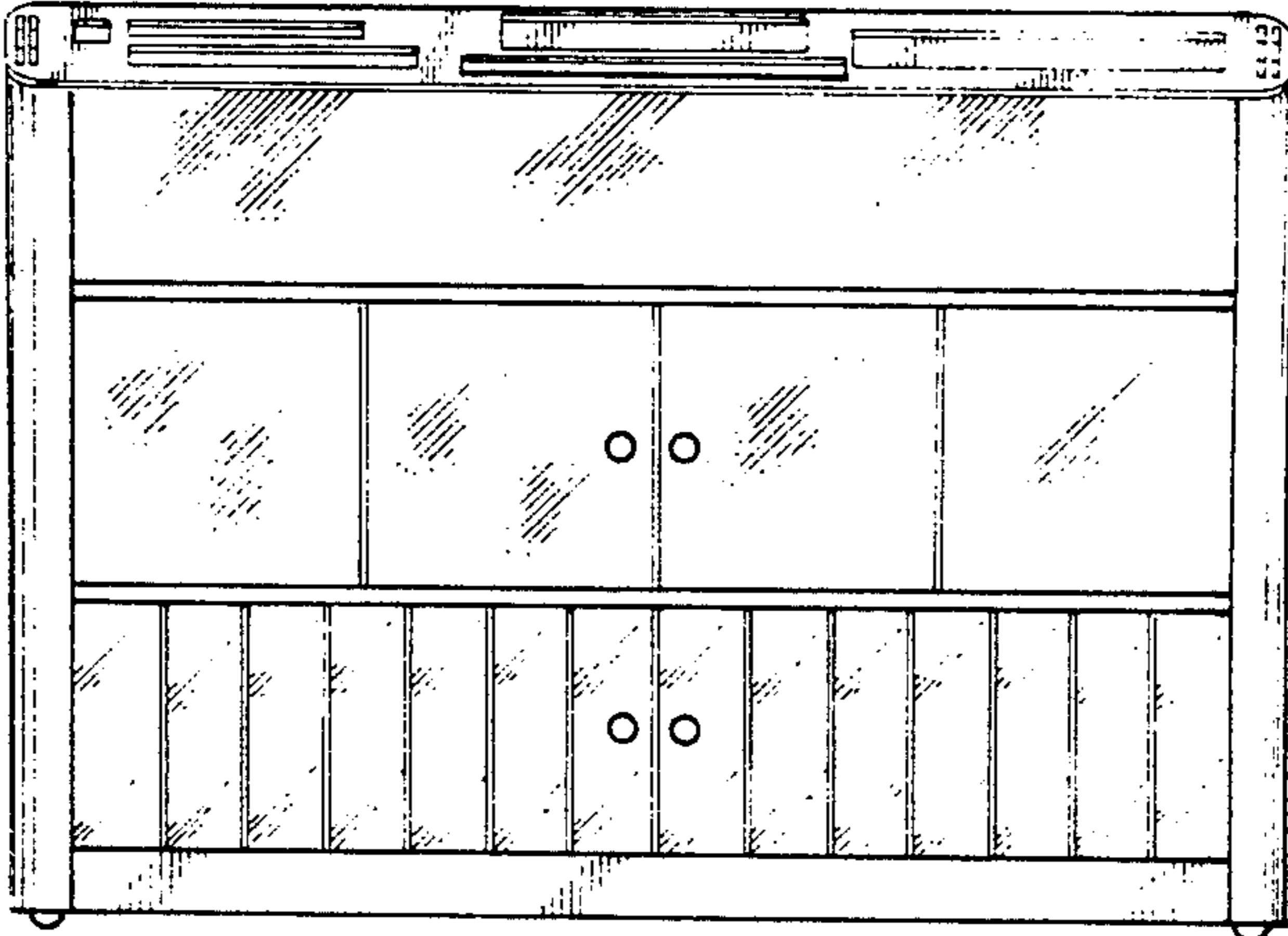
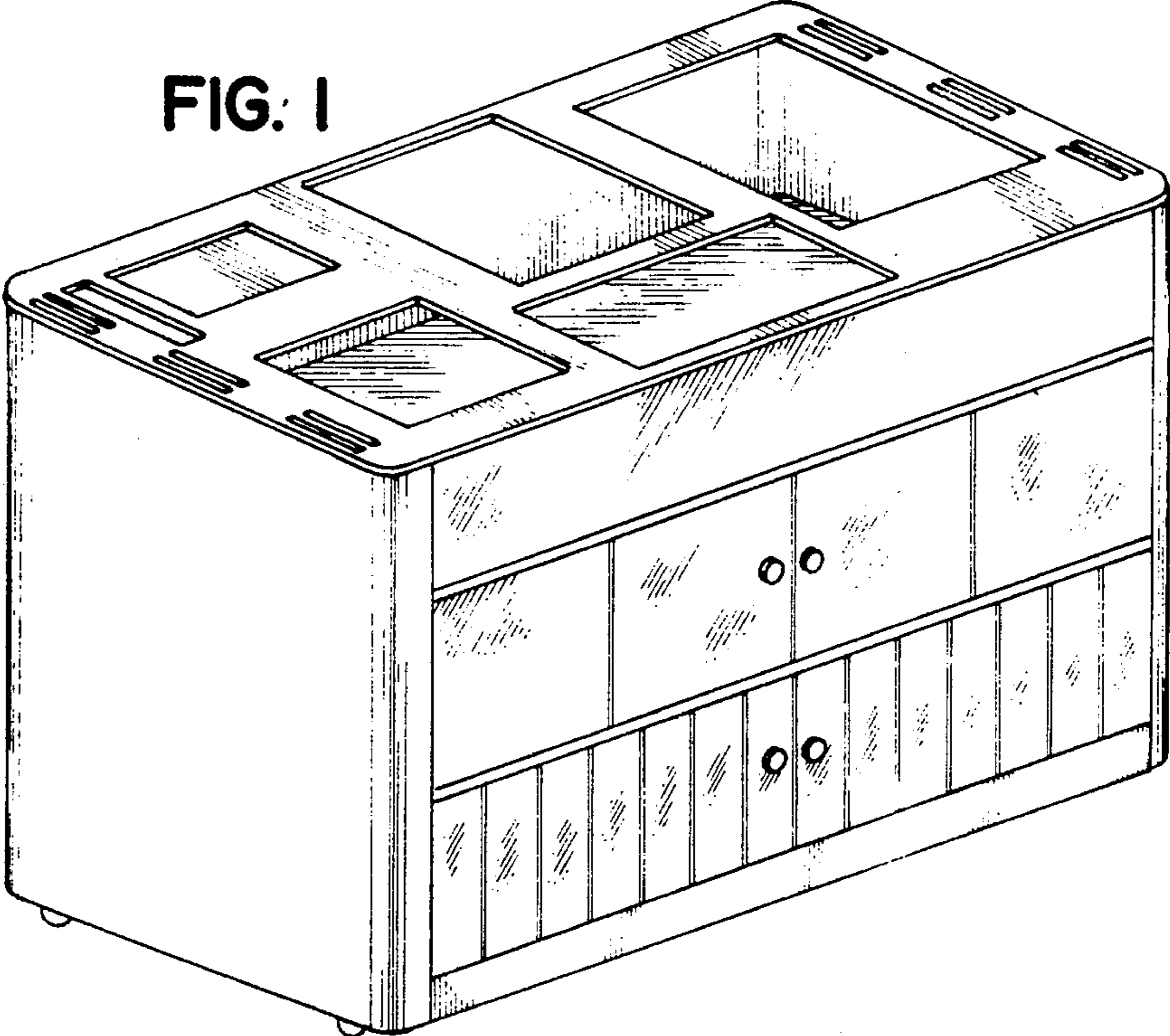

FIG. 2

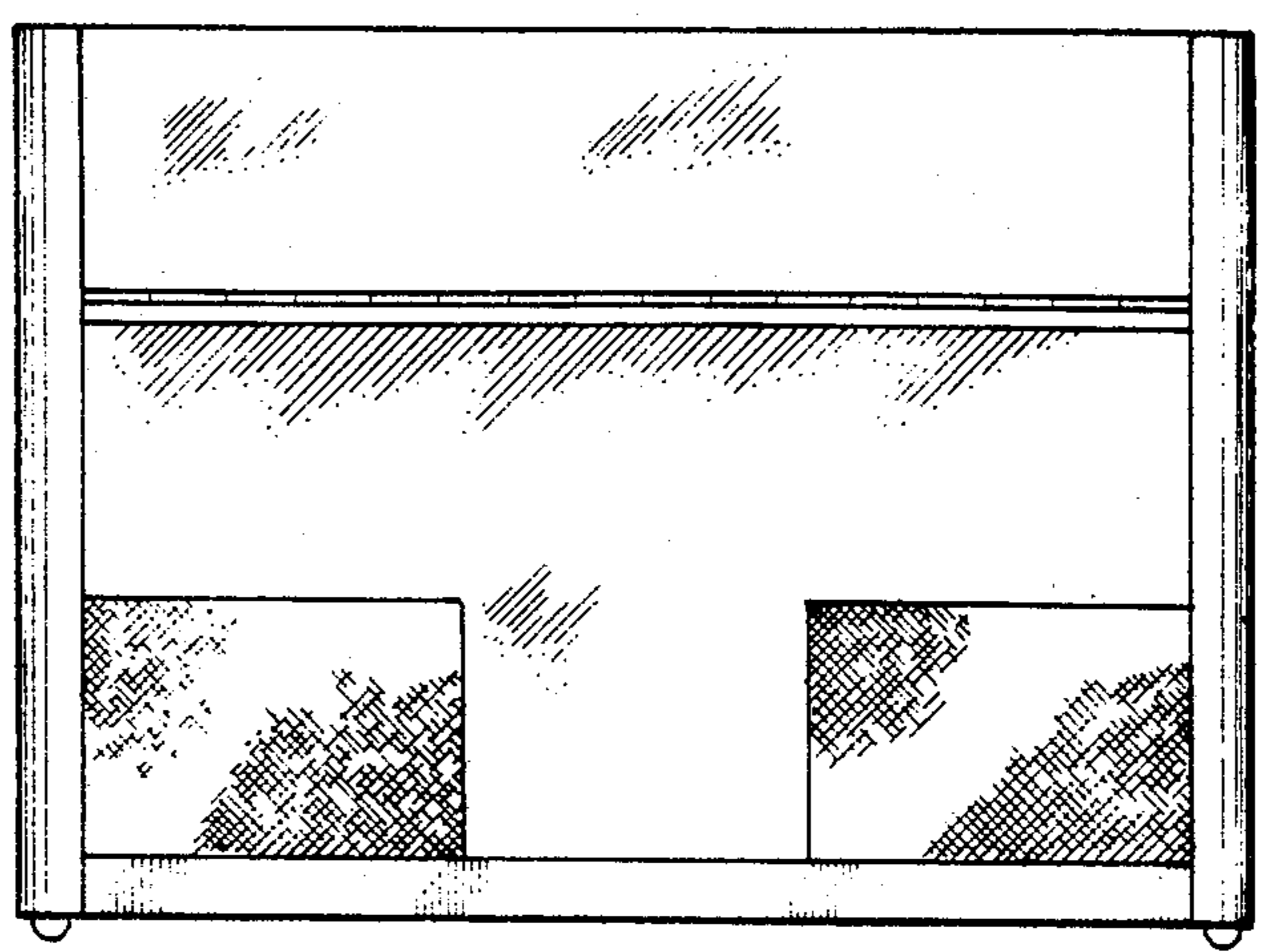

FIG. 3

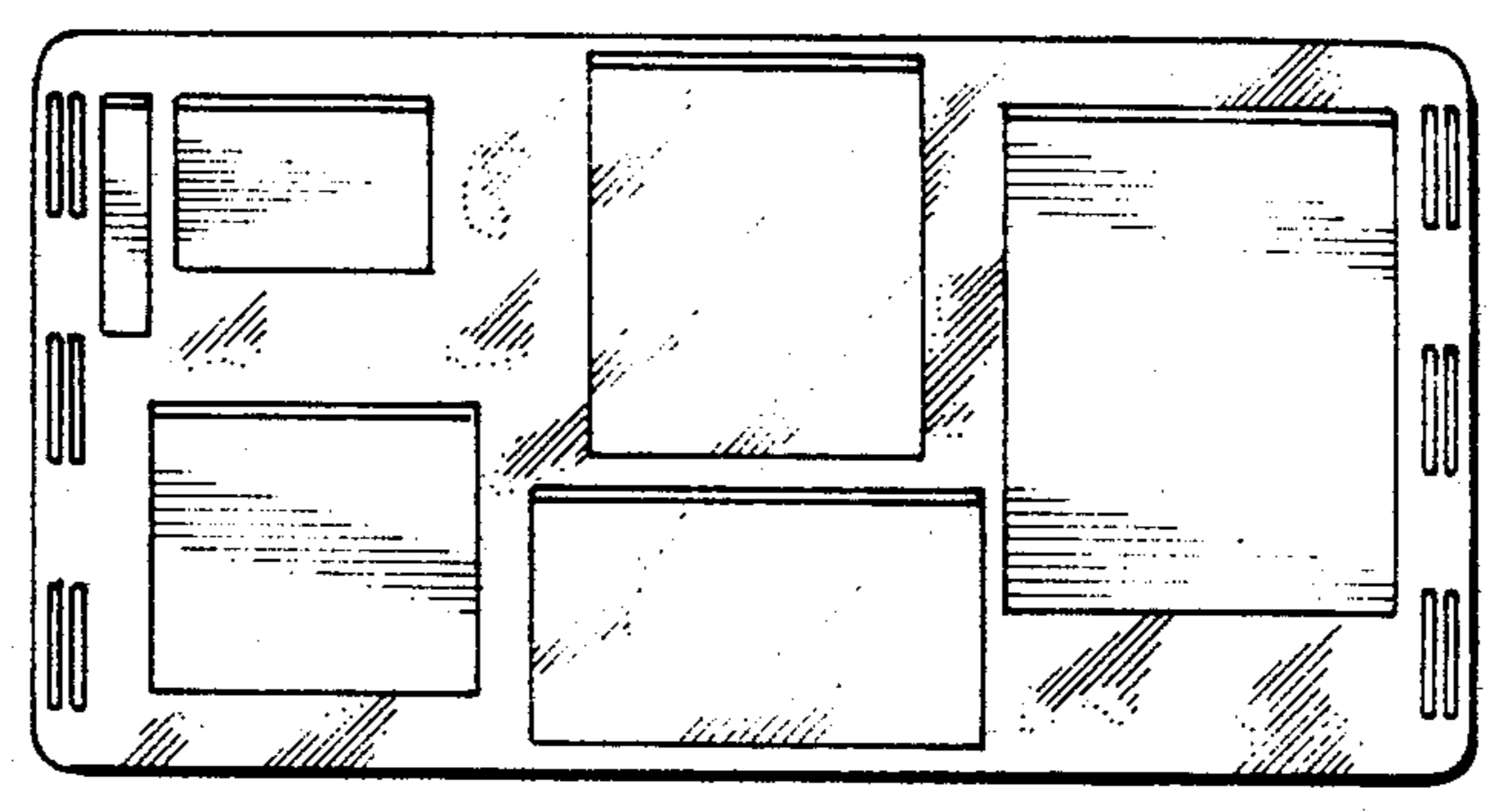

FIG. 4

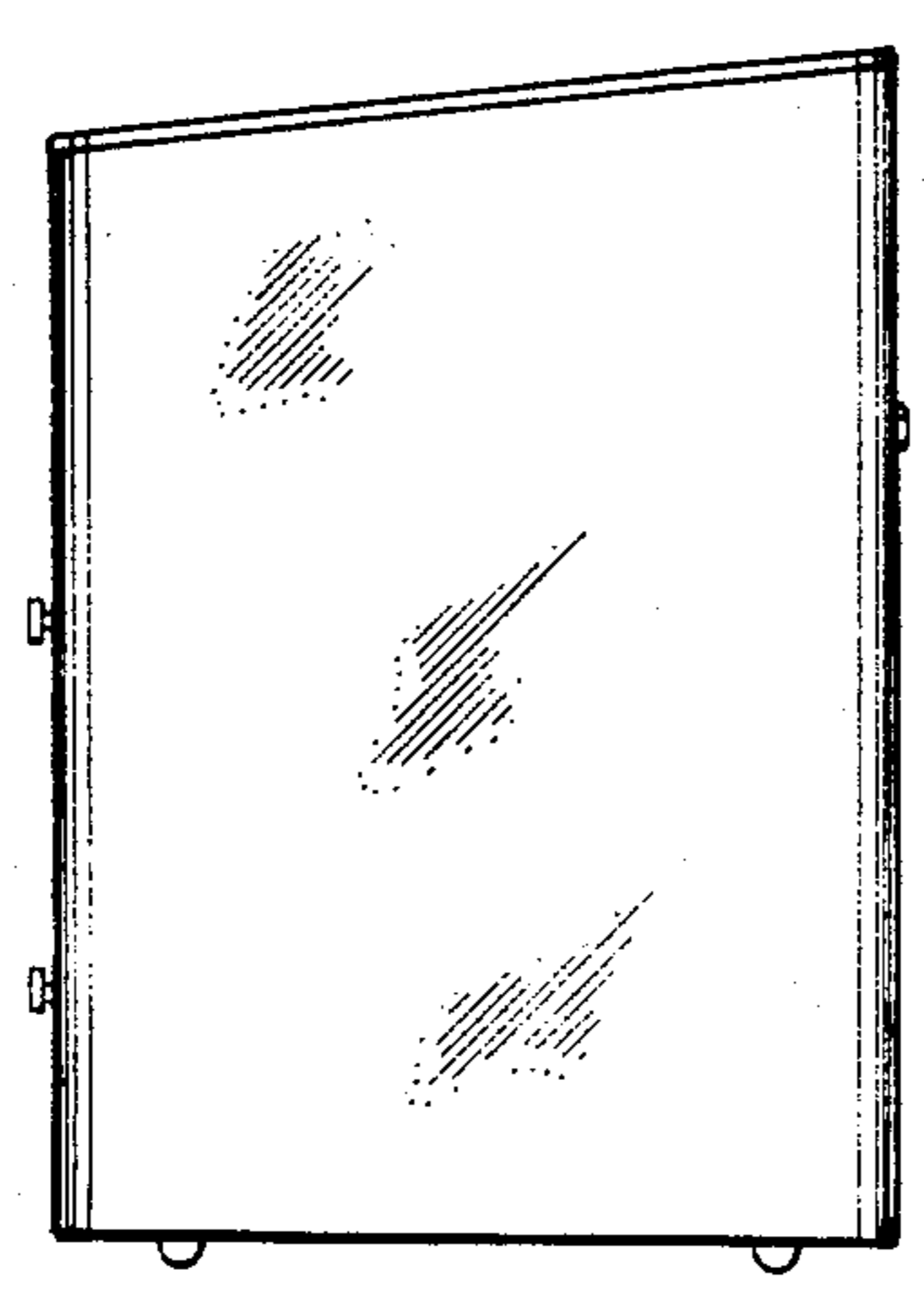

FIG. 5

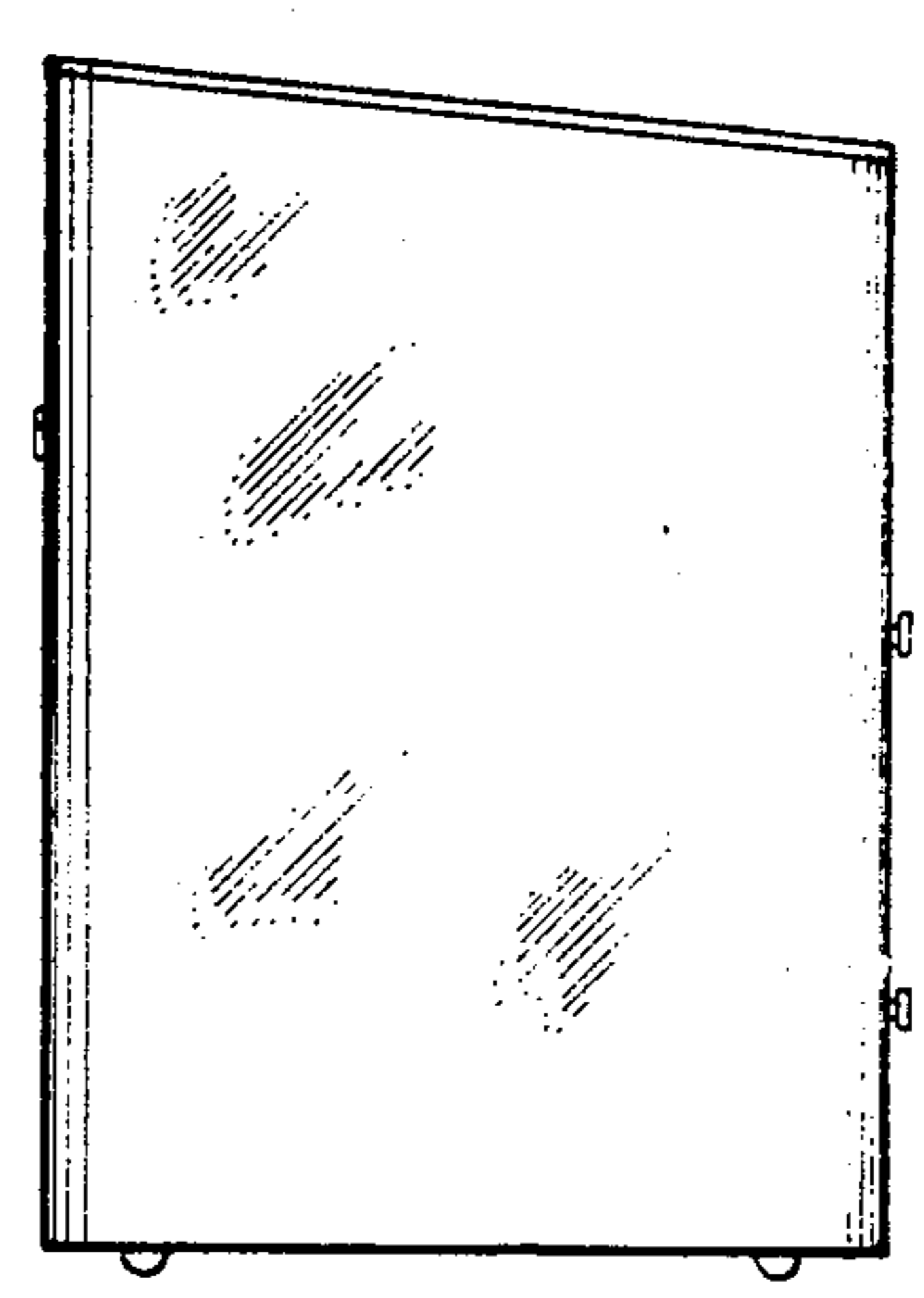

FIG. 6