

[54] CONVERTIBLE CARD TABLE OR SIMILAR ARTICLE

Primary Examiner—Bruce W. Dunkins
Attorney, Agent, or Firm—Leonard Bloom

[76] Inventor: Ruca Chien, No. 77, Kuang Rong Lane, Sec. 2, Chung Shan Rd., Taipei Hsien, Taiwan

[57] CLAIM

The ornamental design for a convertible card table or similar article, substantially as shown and described.

[**] Term: 14 Years

DESCRIPTION

[21] Appl. No.: 688,320

FIG. 1 is a top plan view of a convertible card table or similar article showing my design in position for use as a card table;

[22] Filed: Jan. 2, 1985

FIG. 2 is a side elevational view;

[52] U.S. Cl. D6/430; D6/484

FIG. 3 is an end elevational view;

[58] Field of Search D6/429, 430, 477, 478, D6/480, 484; D21/37

FIG. 4 is a bottom plan view;

[56] References Cited

FIG. 5 is a top plan view showing the beverage glass holders in extended position;

U.S. PATENT DOCUMENTS

FIG. 6 is a view taken in perspective and showing the table in exploded condition for clarity of illustration; and

D. 92,933 7/1934 Sinclair D6/429 X

FIG. 7 is a side elevational view showing the table in converted position for use as a dining table.

D. 96,986 9/1935 Jewell D21/37

The side and end of the table not shown are mirror images of the side and end shown in FIGS. 2 and 3 respectively.

D. 188,462 7/1960 Haye D21/37

D. 225,602 12/1972 Winrow D6/480 X

D. 233,278 10/1974 Wilbourn D21/37 X

D. 238,133 12/1975 Uebele D6/484 X

848,042 3/1907 Musgrave D21/37 X

2,184,677 12/1939 McKay D6/480 X

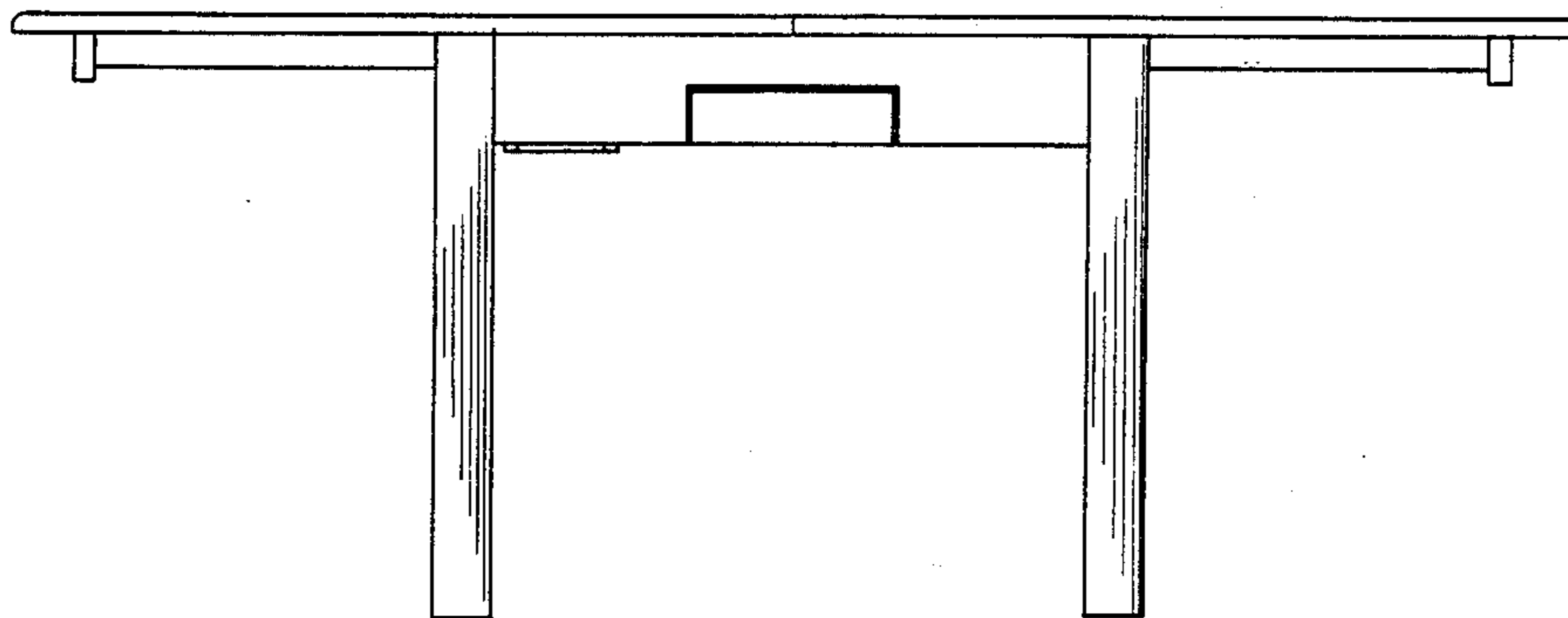

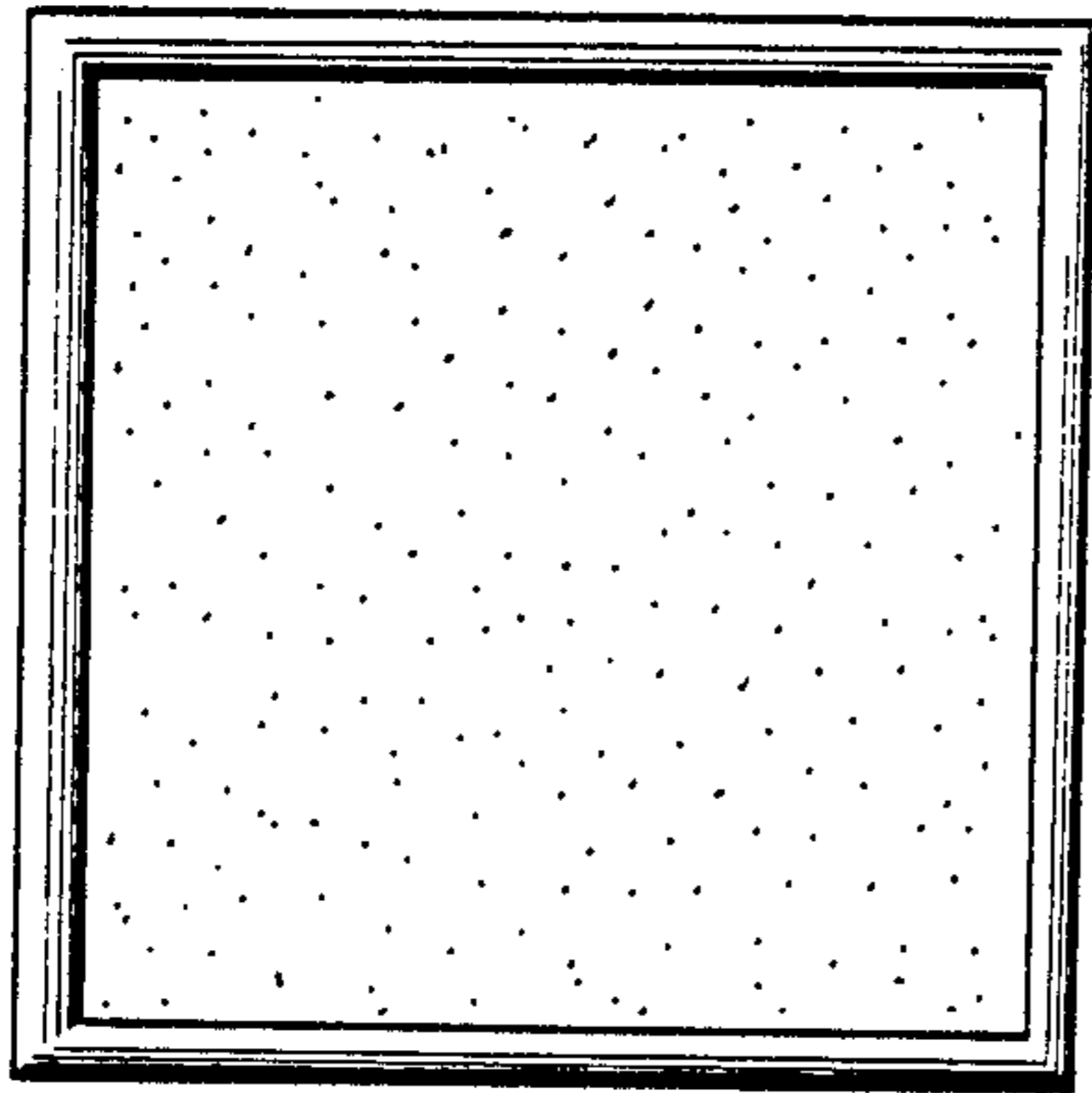

FIG. 1

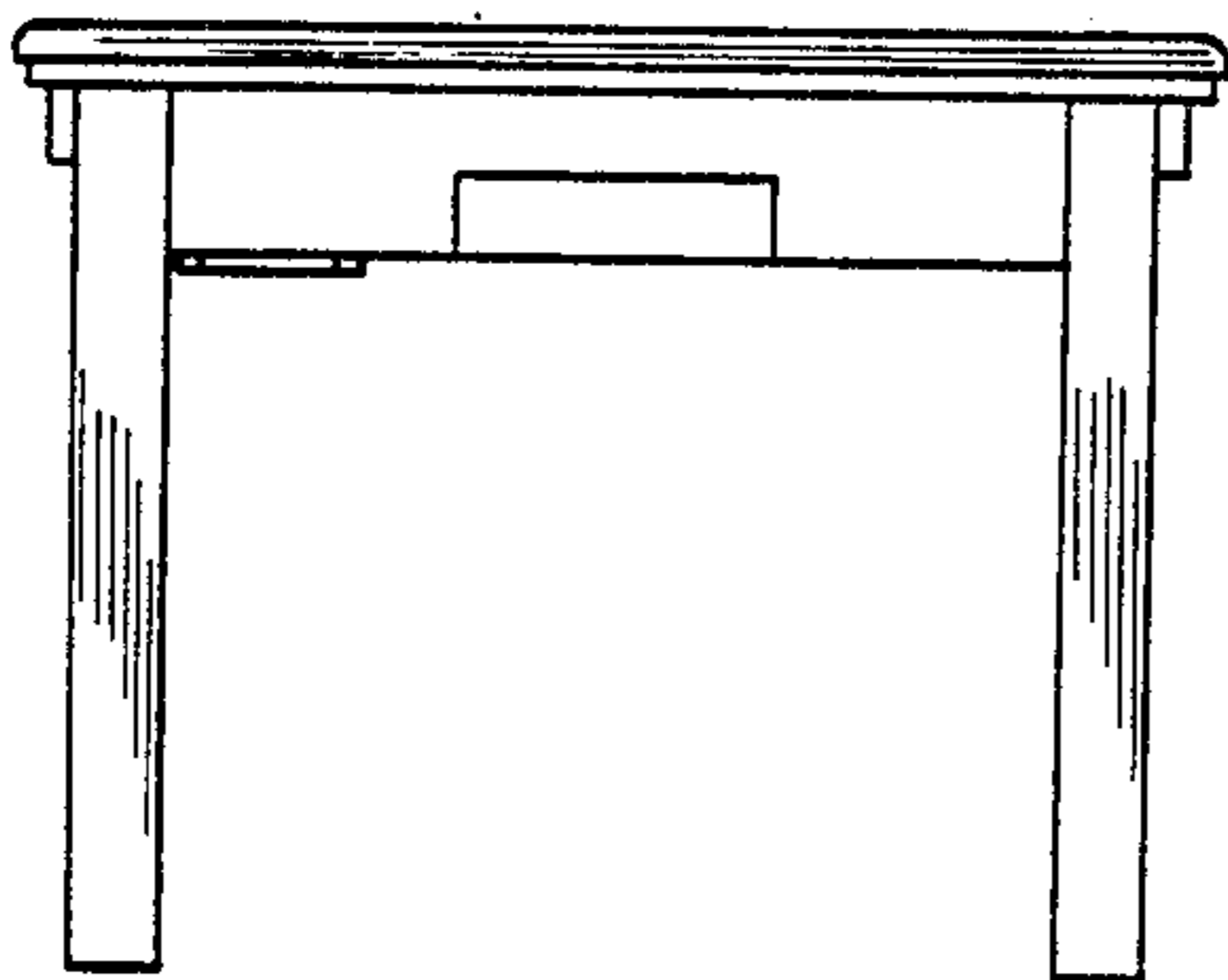

FIG. 2

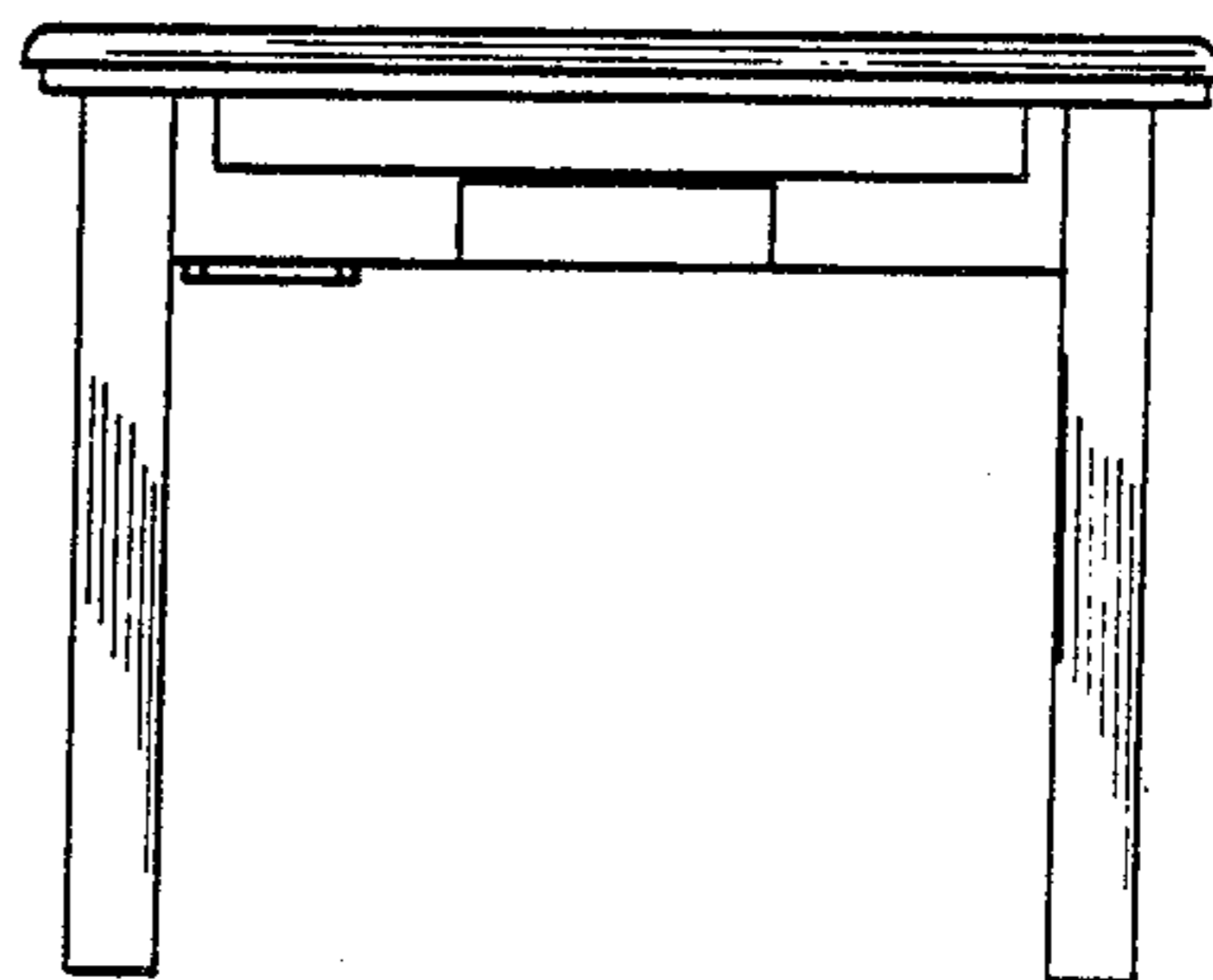

FIG. 3

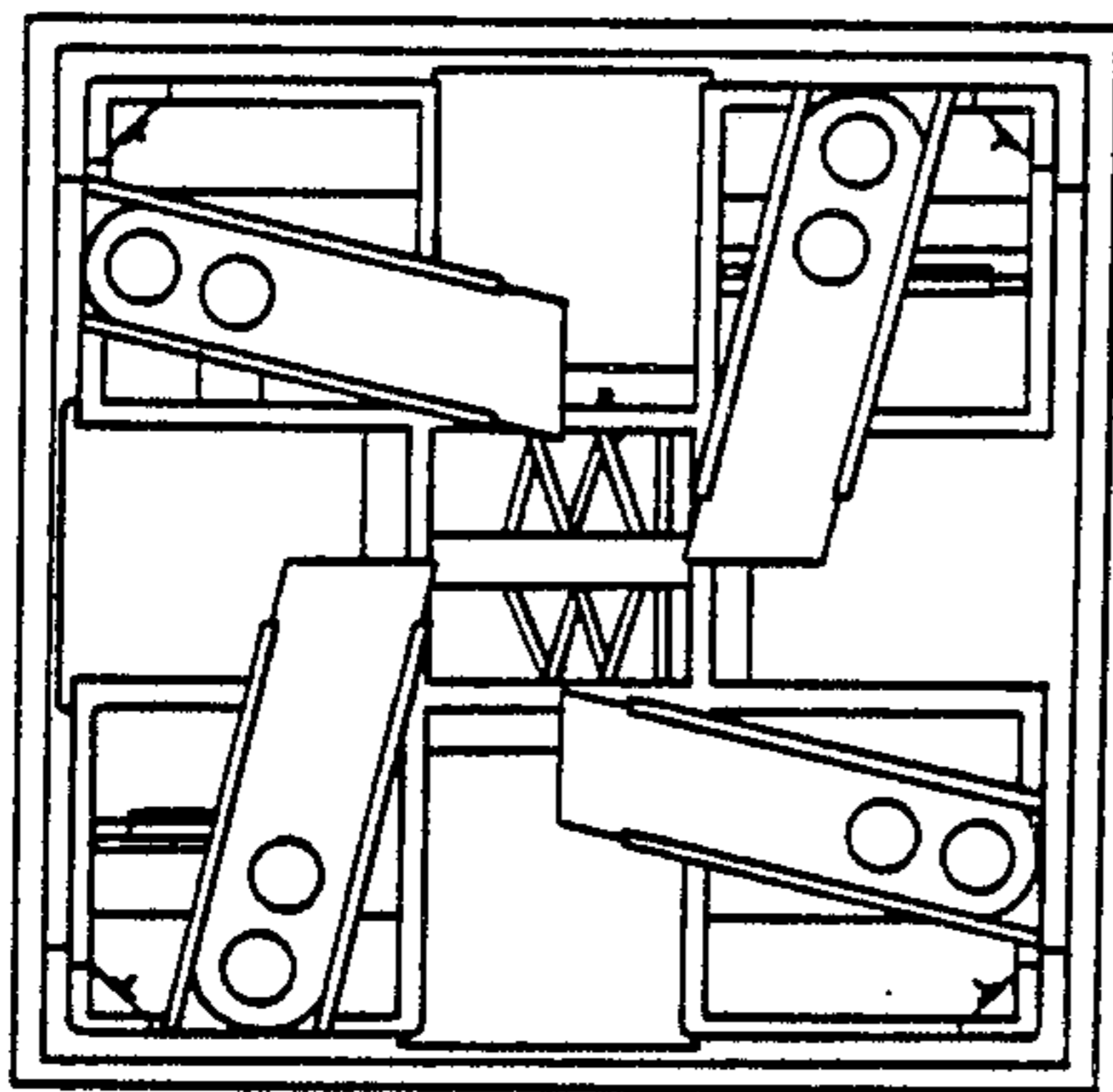

FIG. 4

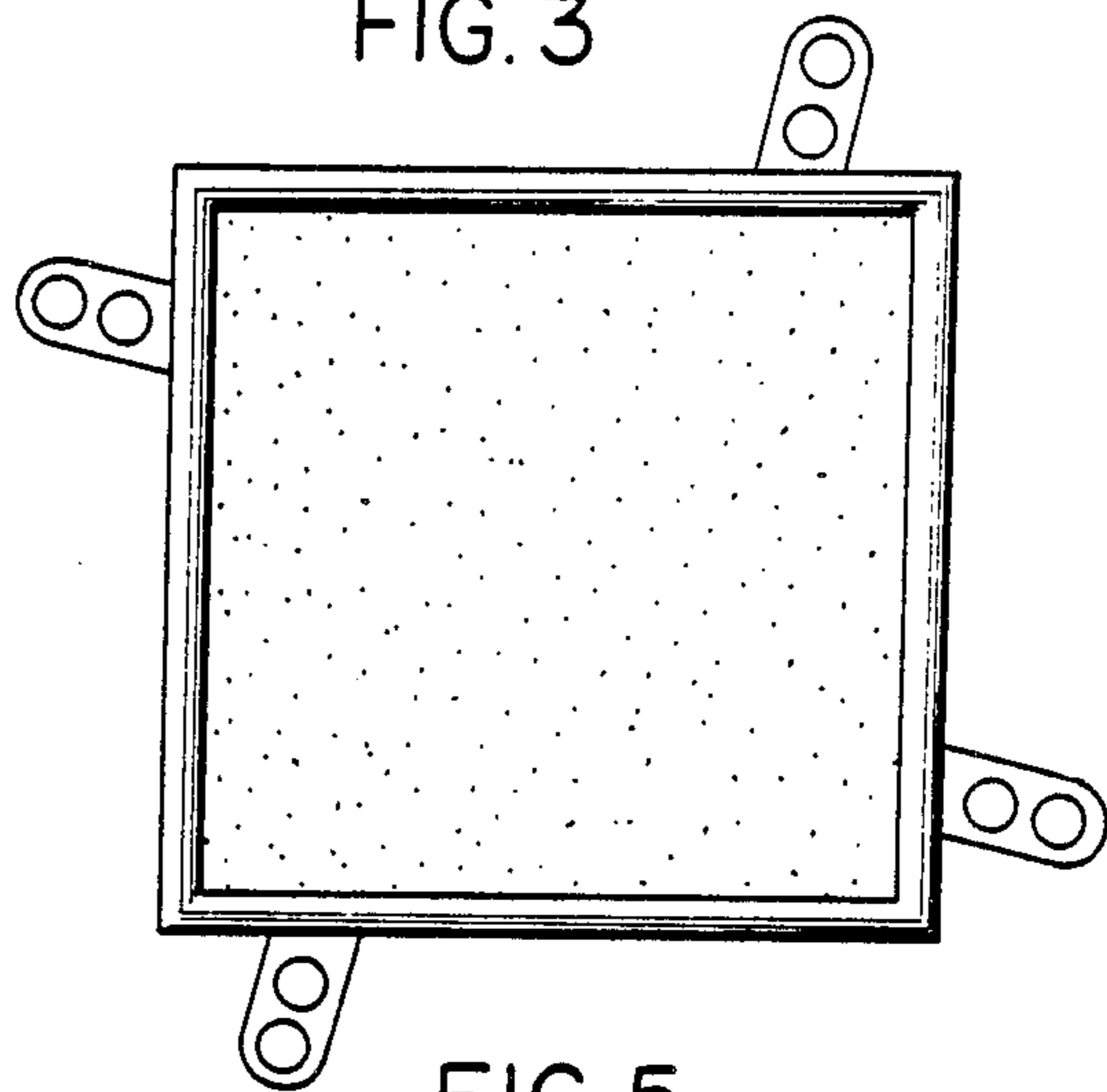

FIG. 5

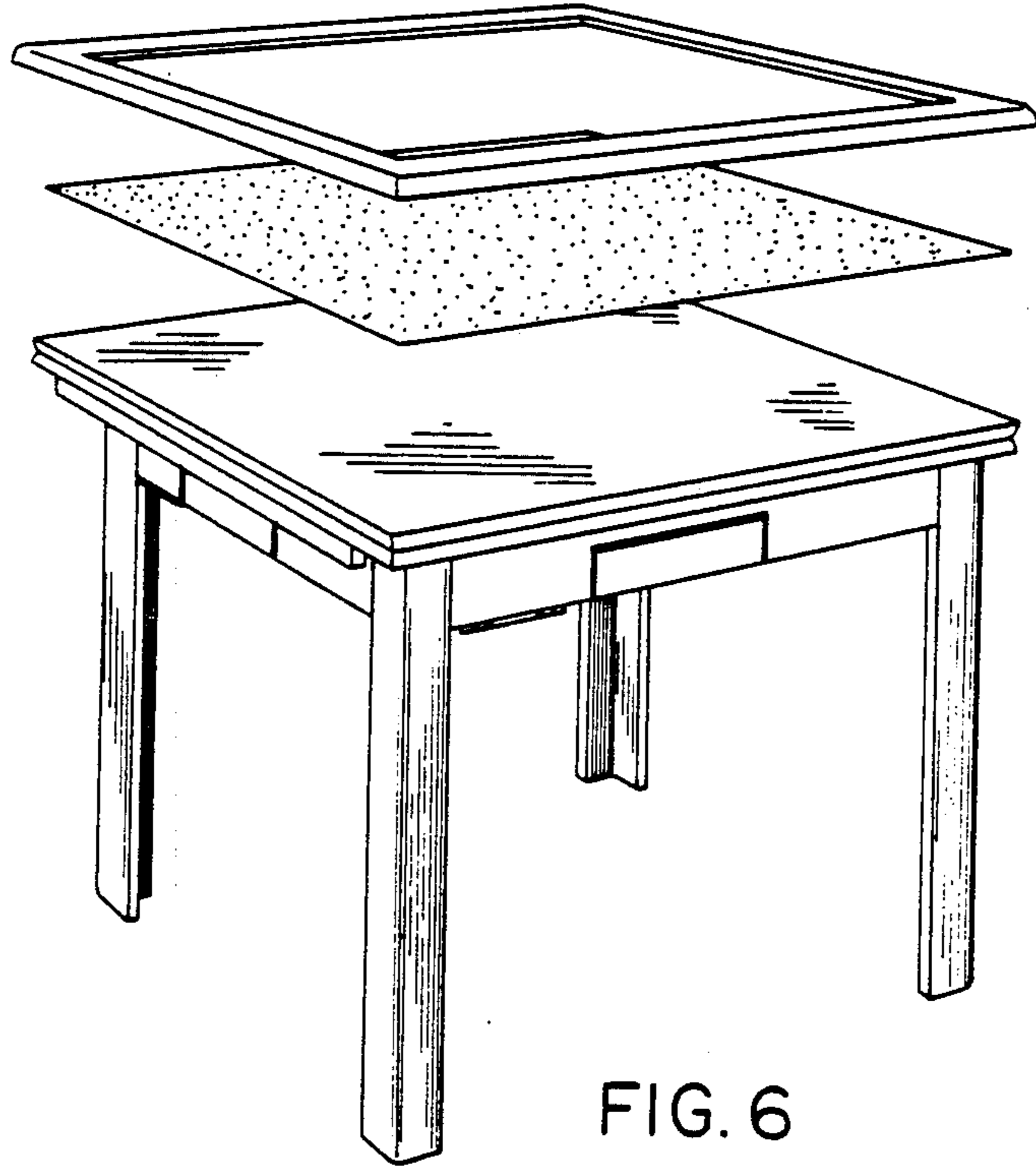

FIG. 6

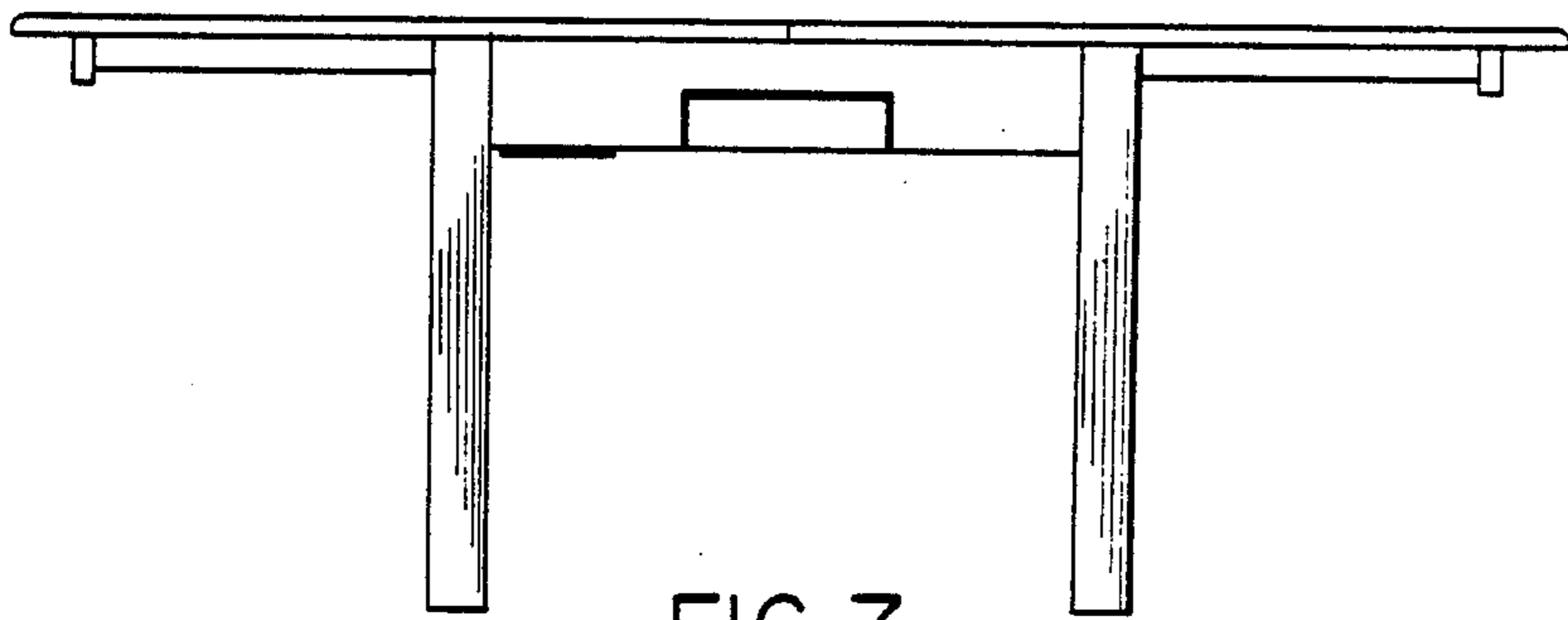

FIG. 7