

[54] DUAL UNIT CONTAINER

[76] Inventor: Allan Costa, 23 Horseshoe Rd., Old Westbury, N.Y. 11568

[**] Term: 14 Years

[21] Appl. No.: 725,698

[22] Filed: Apr. 22, 1985

[52] U.S. Cl. D9/347; D9/370

[58] Field of Search D9/370, 341, 347, 373, D9/374, 375, 376; 215/1 R, 1 C, 6; 220/23.4, 23.86

D. 282,348 1/1986 Federighi D9/341
3,658,204 4/1972 Bottger D9/341 X

Primary Examiner—Robert C. Spangler
Attorney, Agent, or Firm—Beveridge, DeGrandi & Weilacher

[57] CLAIM

The ornamental design for a dual unit container, as shown.

DESCRIPTION

FIG. 1 is a perspective view of a dual unit container showing my new design;
FIG. 2 is an end elevational view;
FIG. 3 is an elevational view showing the side opposite that seen in FIG. 1;
FIG. 4 is a top plan view;
FIG. 5 is a bottom plan view; and
FIG. 6 is an elevational view showing the end opposite that seen in FIG. 2; and
FIG. 7 is a sectional view taken on the line 7—7 of FIG. 3.

[56] References Cited

U.S. PATENT DOCUMENTS

- D. 100,412 7/1936 Carp D9/347
- D. 147,120 7/1947 Dietrich D9/341 X
- D. 210,324 2/1968 Rapaz D9/347
- D. 219,642 1/1971 Prahs D9/347
- D. 220,864 6/1971 Weckman D9/347
- D. 270,135 8/1983 Gates D9/341
- D. 270,237 8/1983 Hestehave D9/341

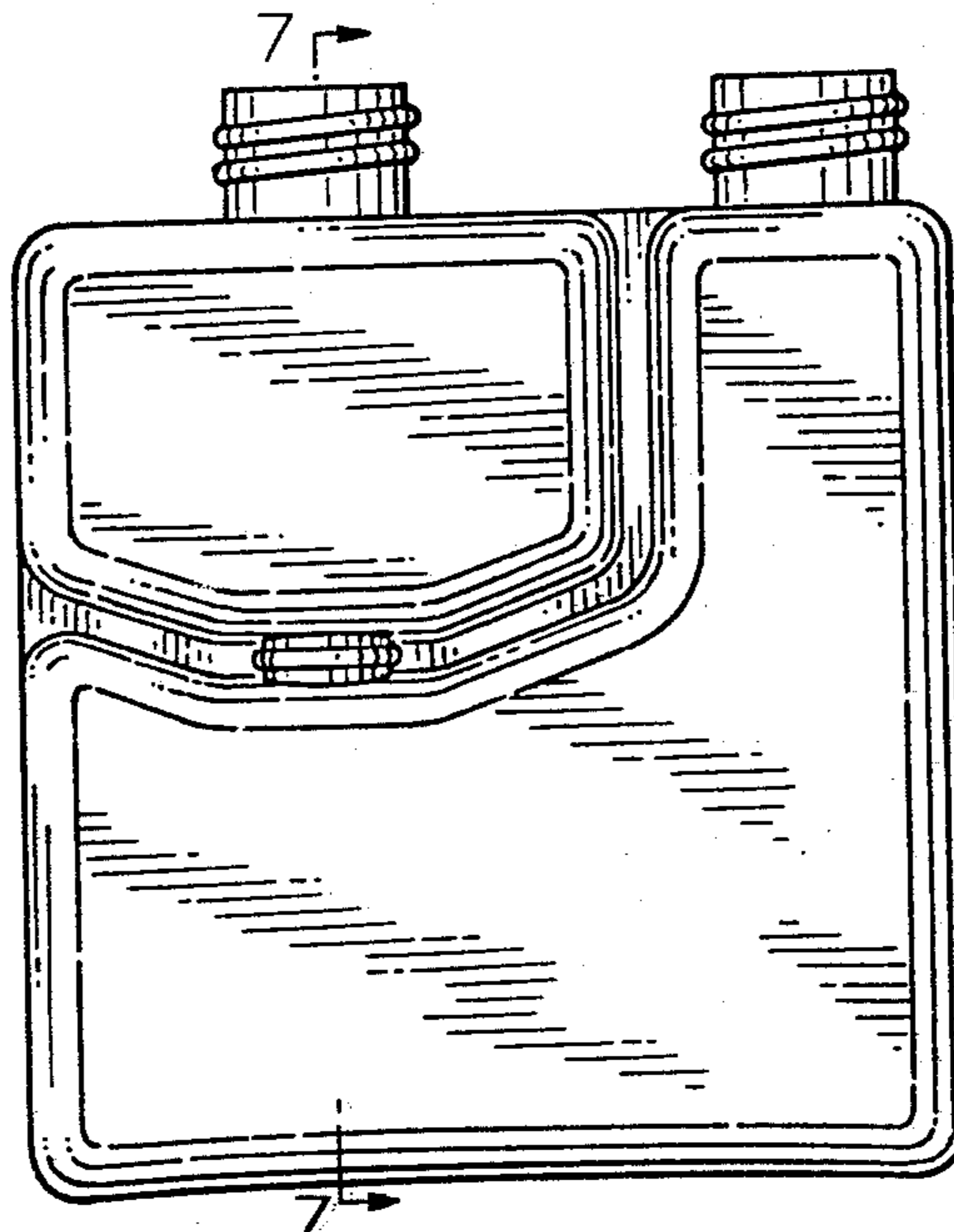

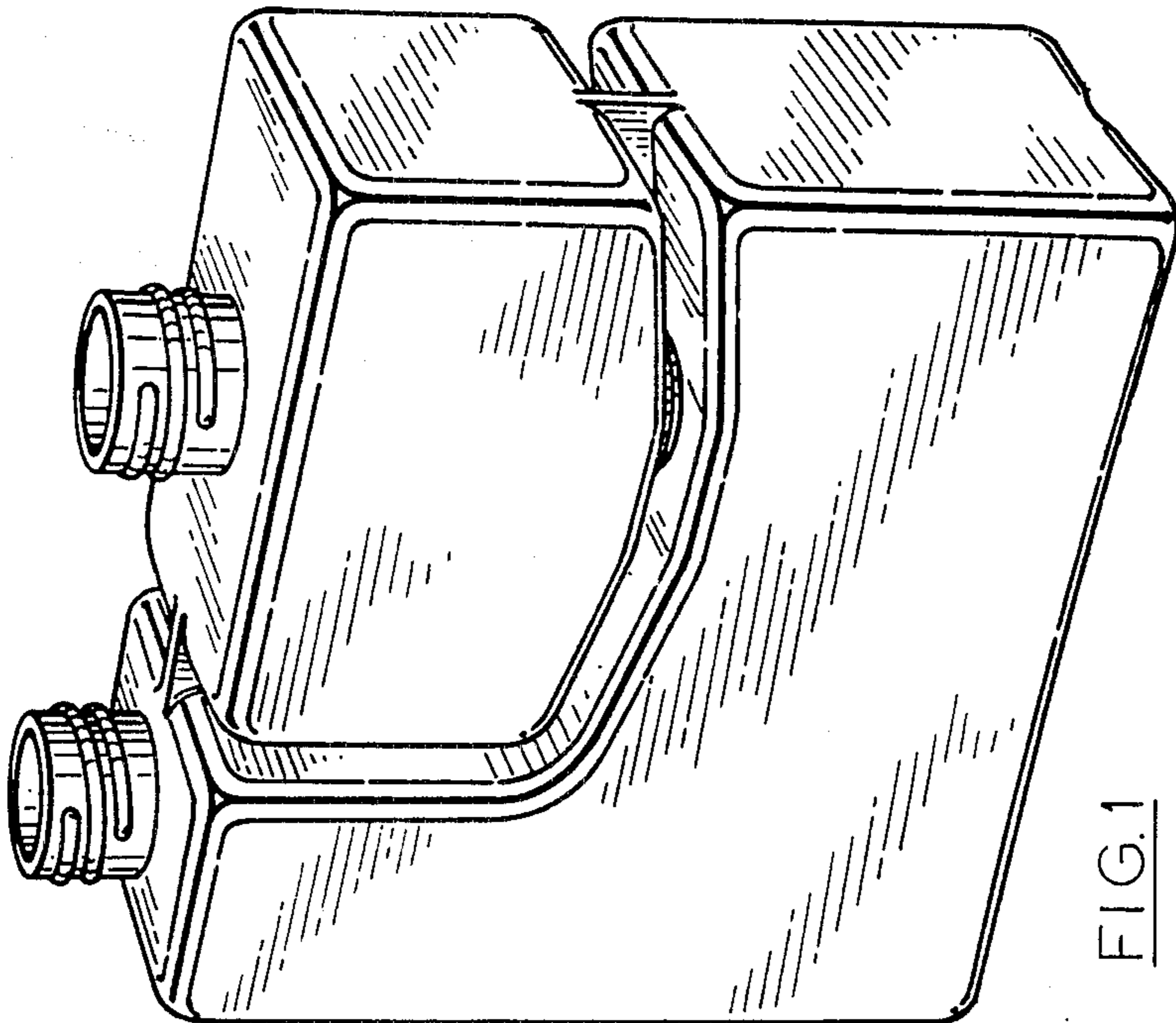

FIG. 1

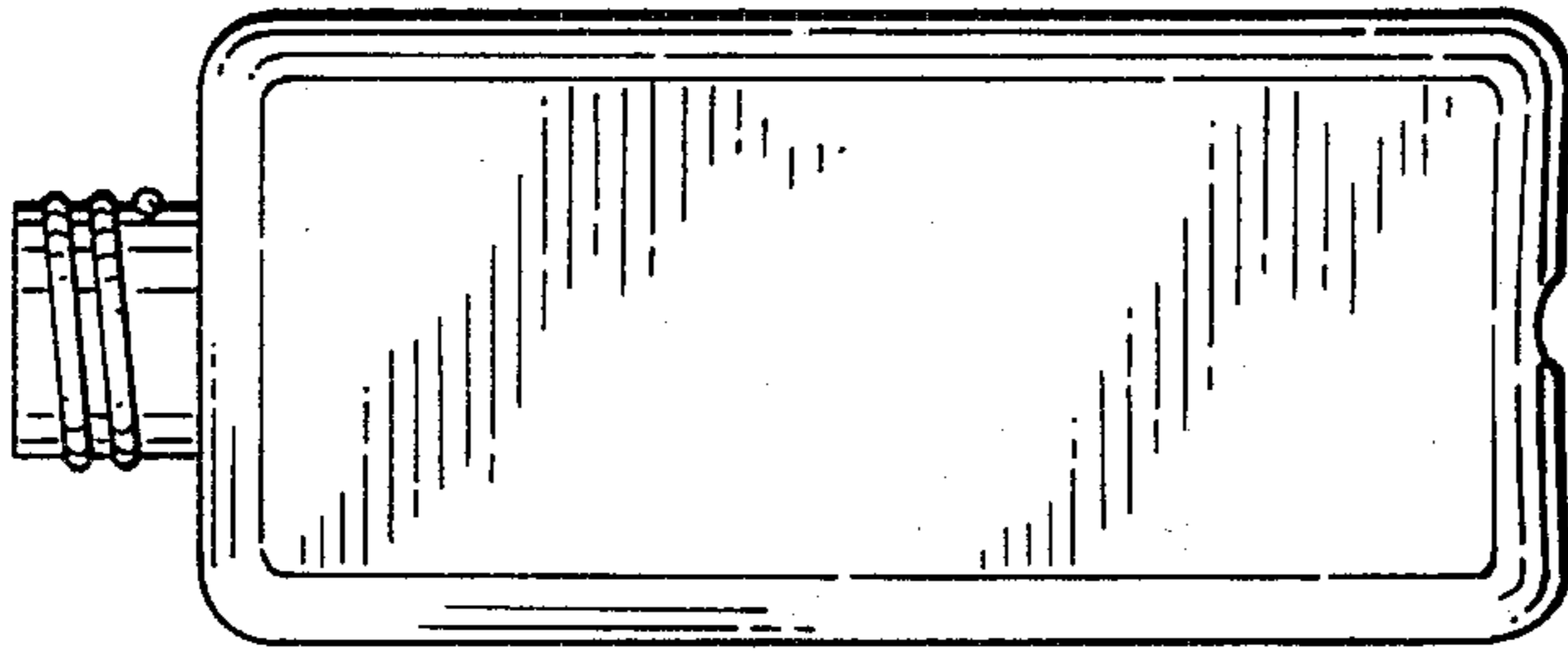

FIG. 2

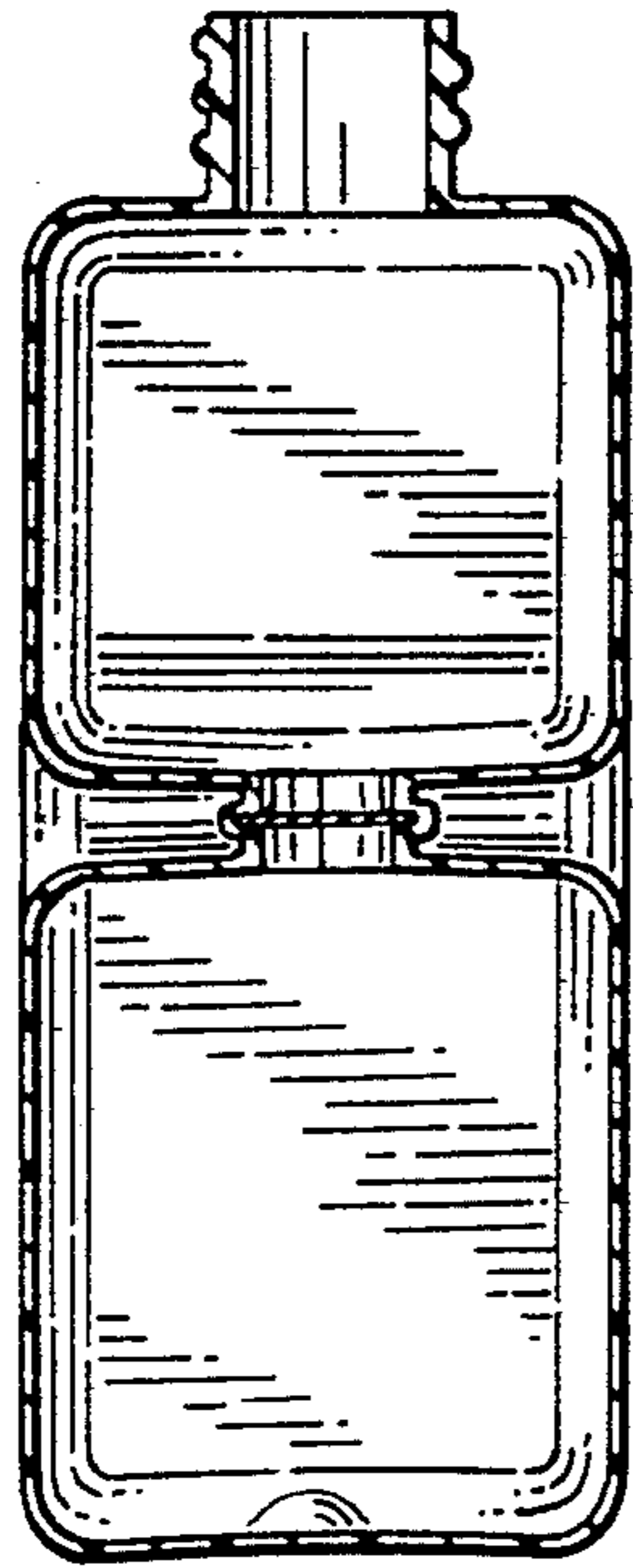

FIG. 7

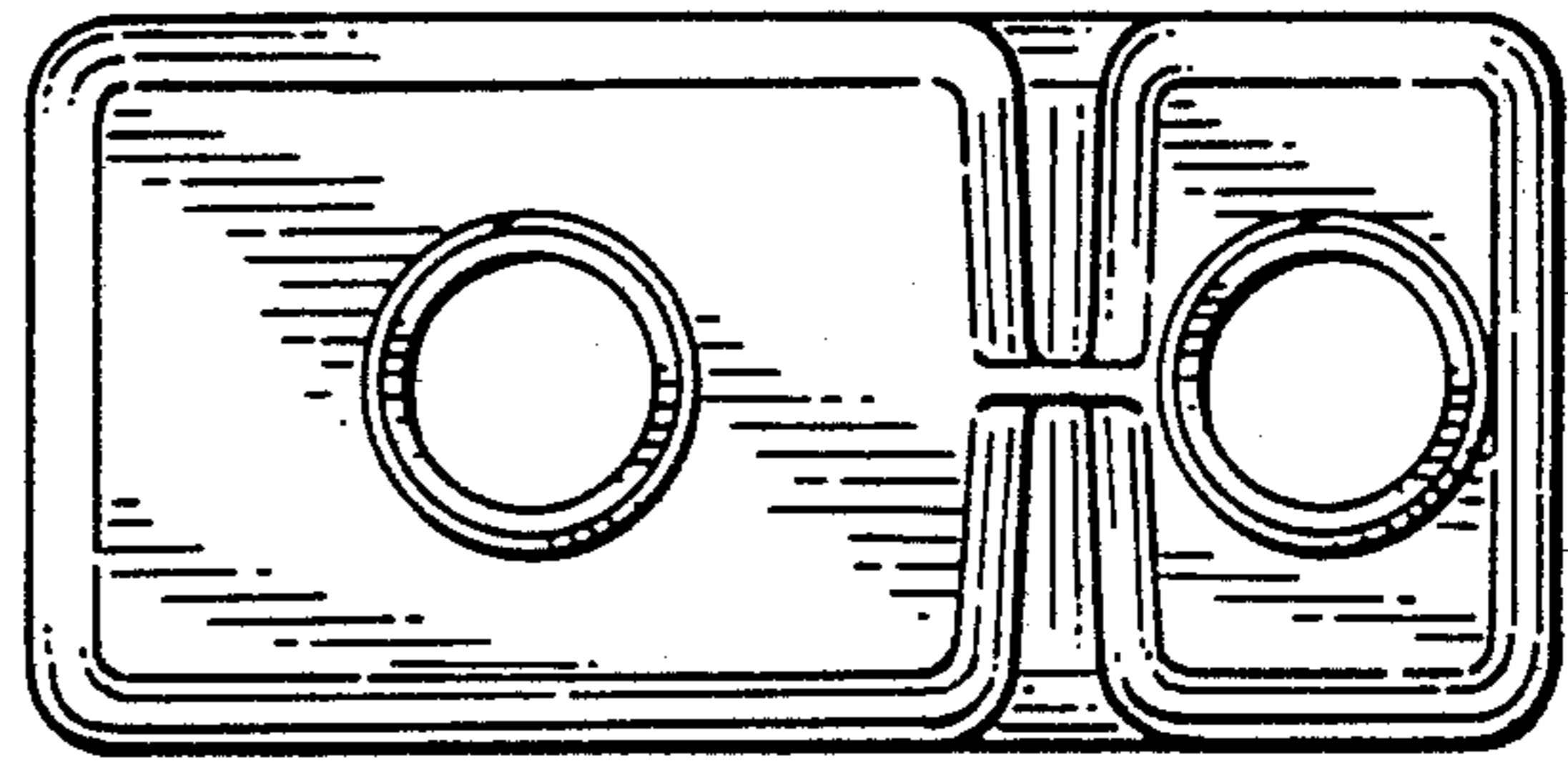

FIG. 4

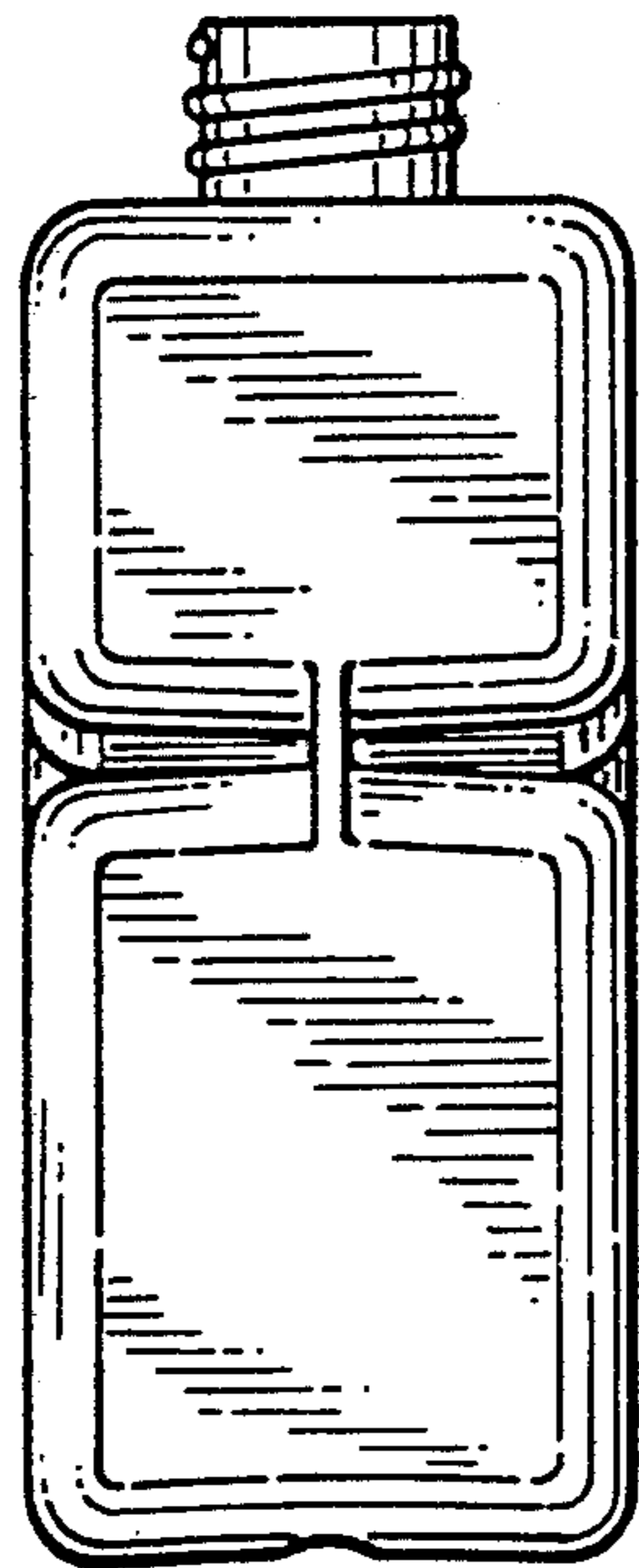

FIG. 6

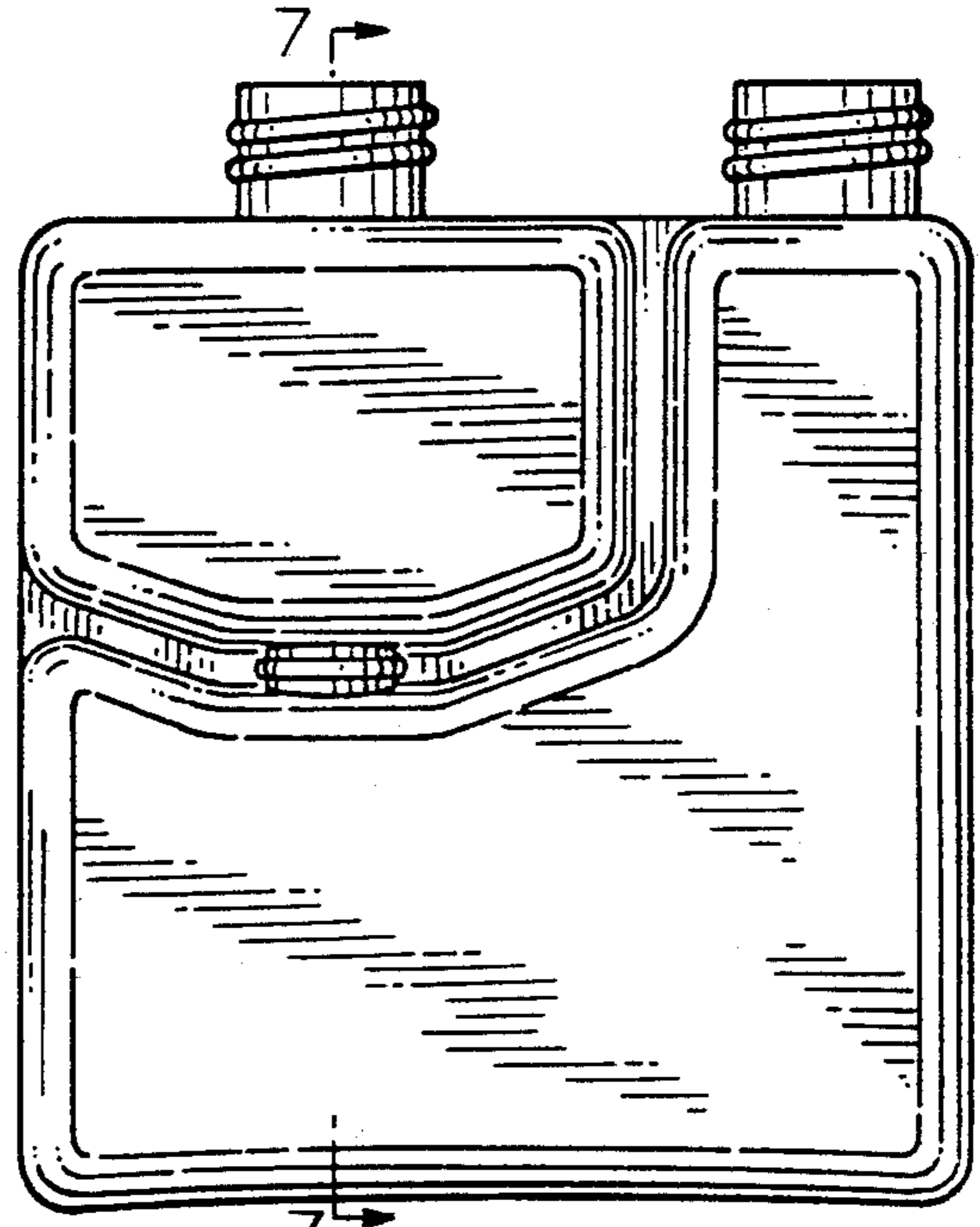

FIG. 3

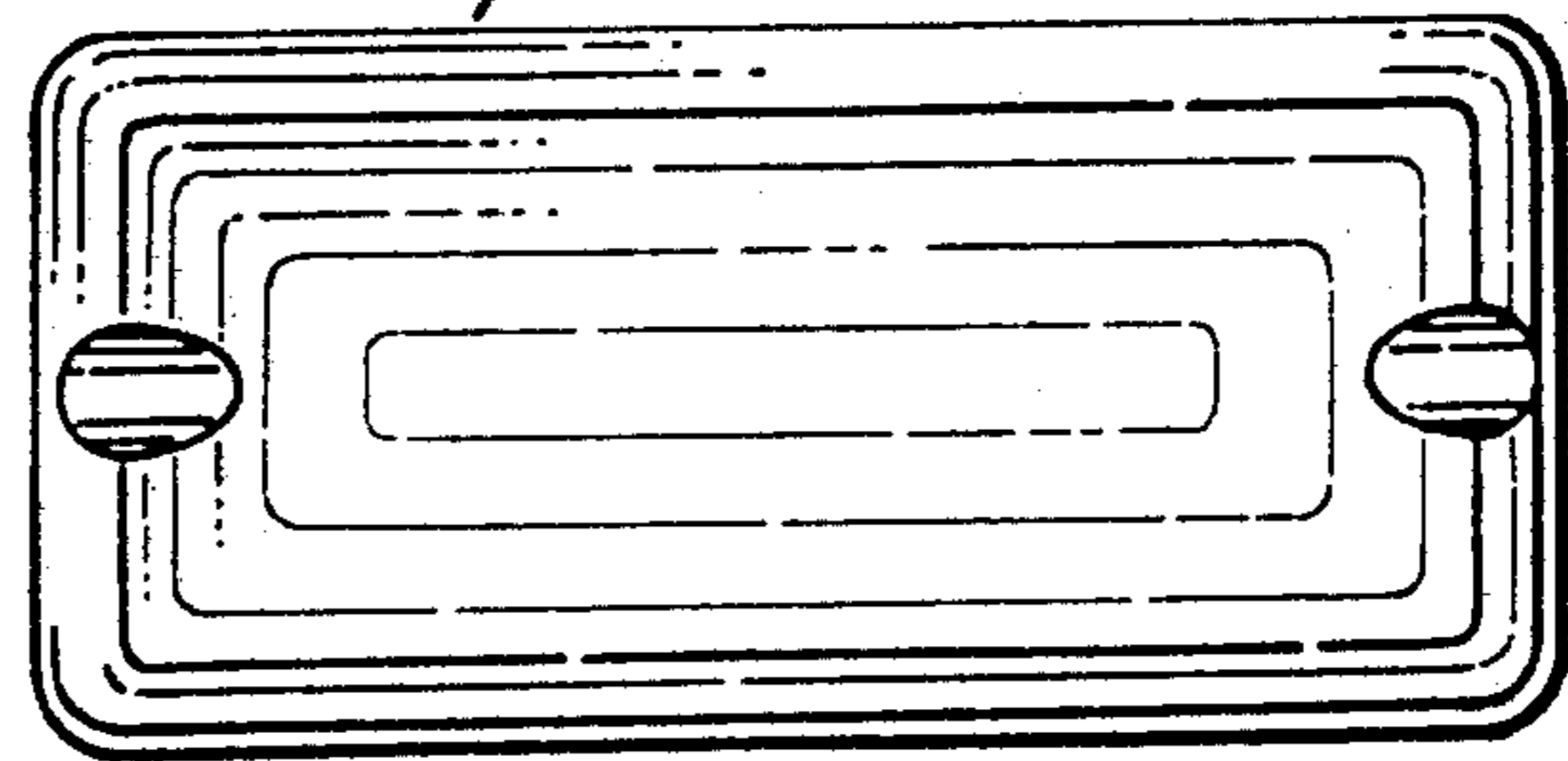

FIG. 5