

[54] FLOWER POT COVER

[75] Inventors: Donald E. Weder; Erwin H. Weder, both of Highland; Robert C. Abrams, Edwardsville, all of Ill.

[73] Assignee: Highland Supply Corporation, Highland, Ill.

[**] Term: 14 Years

[21] Appl. No.: 717,853

[22] Filed: Mar. 29, 1985

Related U.S. Application Data

[63] Continuation-in-part of Ser. No. 613,053, May 22, 1984.

[52] U.S. Cl. D11/164; D5/21; D11/149

[58] Field of Search D11/143, 152, 164; D9/305, 306, 444, 455; D5/13, 9, 14, 21, 26, 61, 65; 47/41, 66, 72; 150/52 R; 206/423; 229/3.5 MF, 4.5, 87 P; 248/27.8; 428/35, 542.6

[56] References Cited

U.S. PATENT DOCUMENTS

4,508,223 4/1985 Catrambone 206/423

OTHER PUBLICATIONS

- Pot Cover; Jacobson Pot Cover Co.; exhibit B; date unknown.
- Platform Pot Dresser; John Baisen Corp.; exhibit C; date unknown.
- Floral Decor Cover; John Henry Co.; exhibit D; date unknown.
- Pot Cover; Klerk's Plastic Industrie B.V.; exhibit E; date unknown.

- Pot Covers; unrelated and unknown; exhibits L&M; date unknown.
- Straw-like Cover; origin unknown; exhibit N; date unknown.
- Basket-like Cover; origin unknown; exhibit O; date unknown.
- Dennison "Paches"; Spring issue; p. 45; Easter Napkin E.708.
- Redi-Wrap Flower Pot; Curtis Wagner Co.; Inc.; date unknown; exhibit A.
- Flower Pot Covers; Highland Supply Corp.; never available to public; exhibit F.
- Flower Pot Wrappings; various sources; no date known; exhibit G.
- Straw-like Pot Cover; source unknown; date unknown; exhibit H.
- Flower Pot Cover; source unknown; date unknown; item 3.

Primary Examiner—B. J. Bullock

[57] CLAIM

The ornamental design for a flower pot cover, substantially as shown and described.

DESCRIPTION

FIG. 1 is a plan view of the flower pot cover showing our new design.

FIG. 2 is a front elevational view thereof.

FIG. 3 is a rear elevational view thereof.

FIG. 4 is a side elevational view thereof.

FIG. 5 is a side elevational view similar to FIG. 4, but showing the side opposite that shown in FIG. 4.

FIG. 6 is a bottom plan view thereof, the pattern which is partially shown is understood to repeat across the outer surface.

FIG. 7 is an enlarged plan view of the pattern shown in FIG. 6.

The flower pot cover has no substantial thickness.

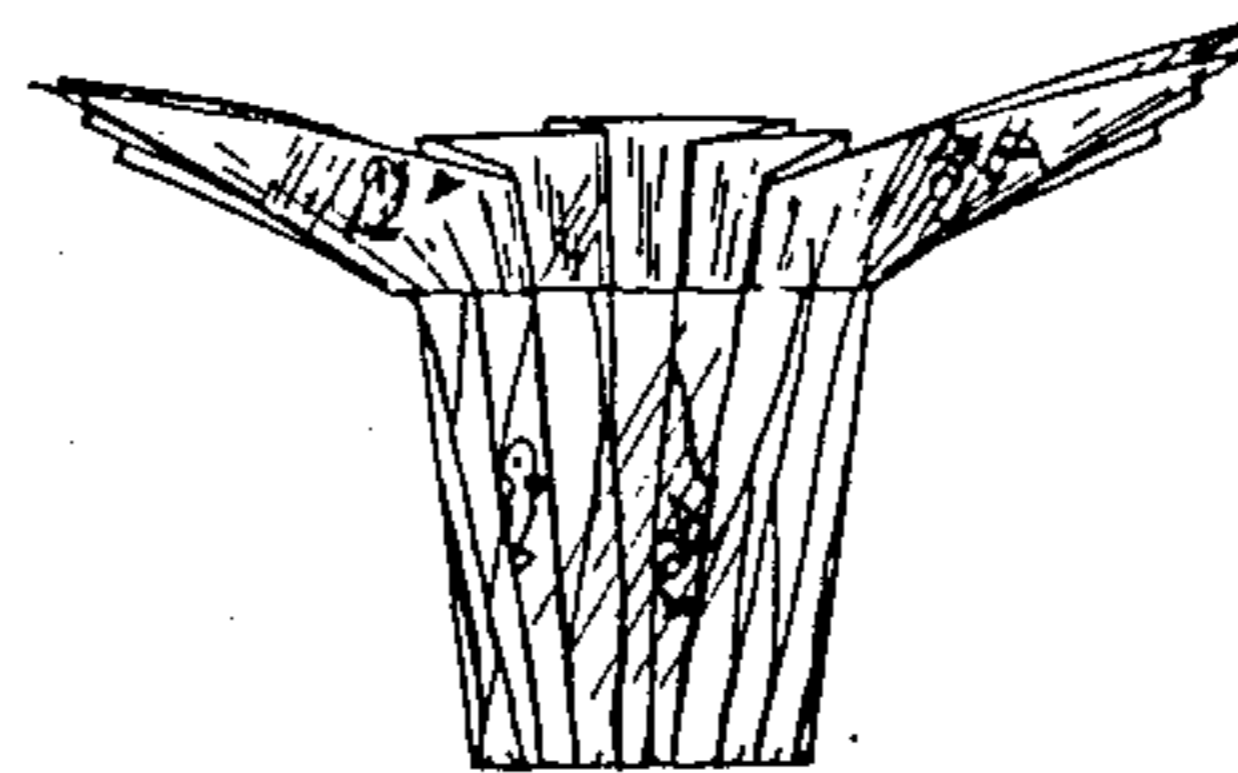
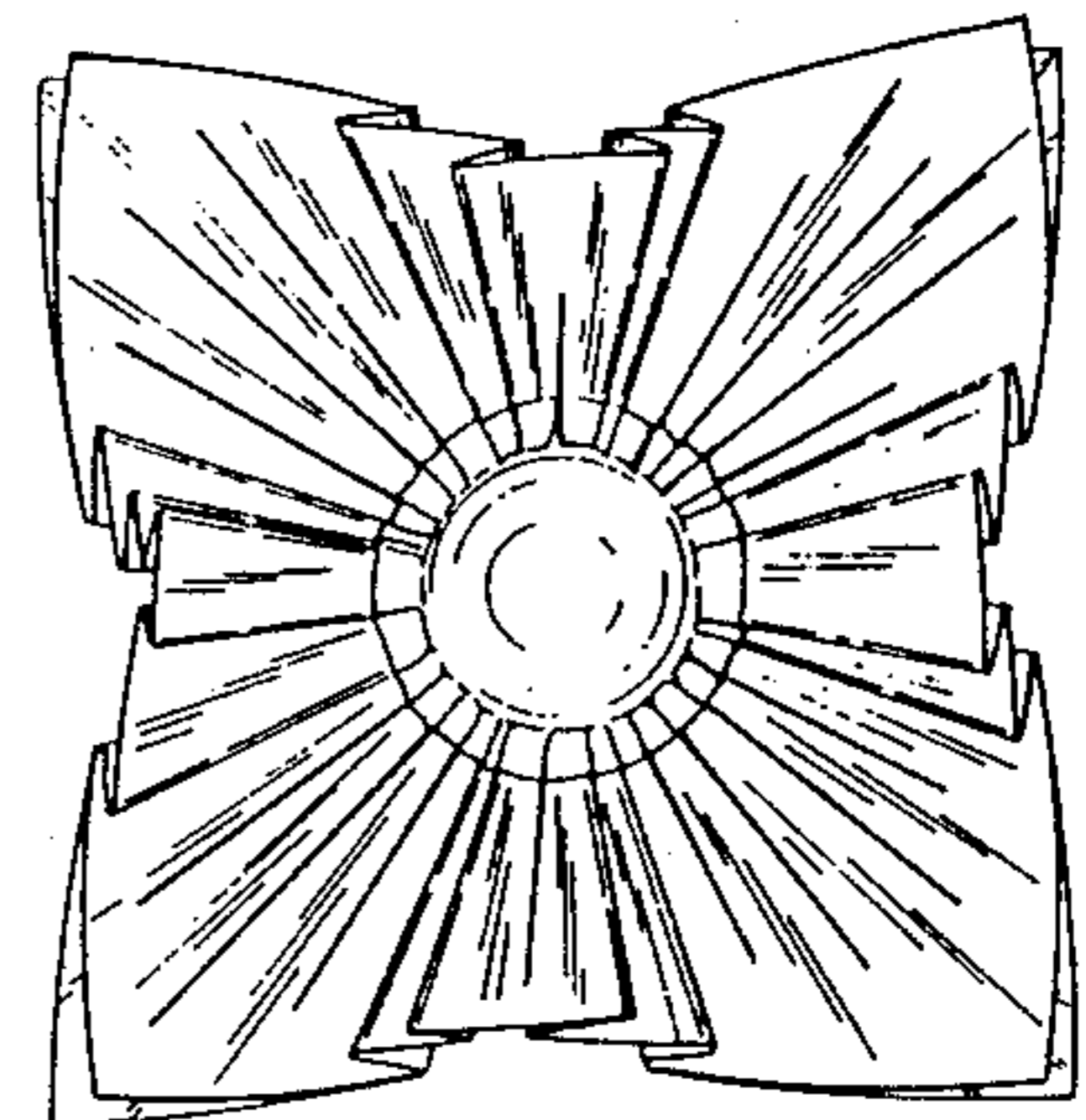
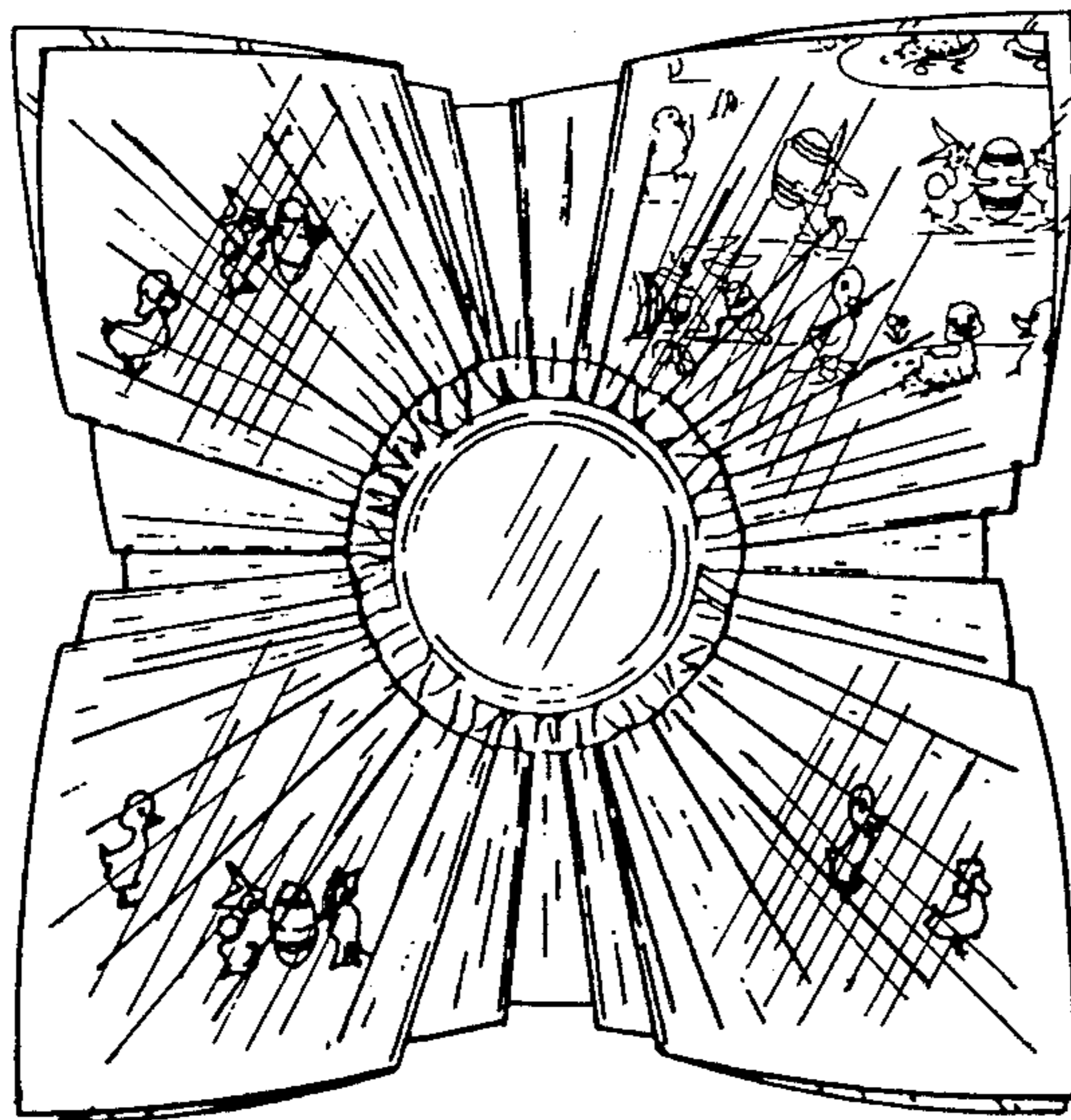

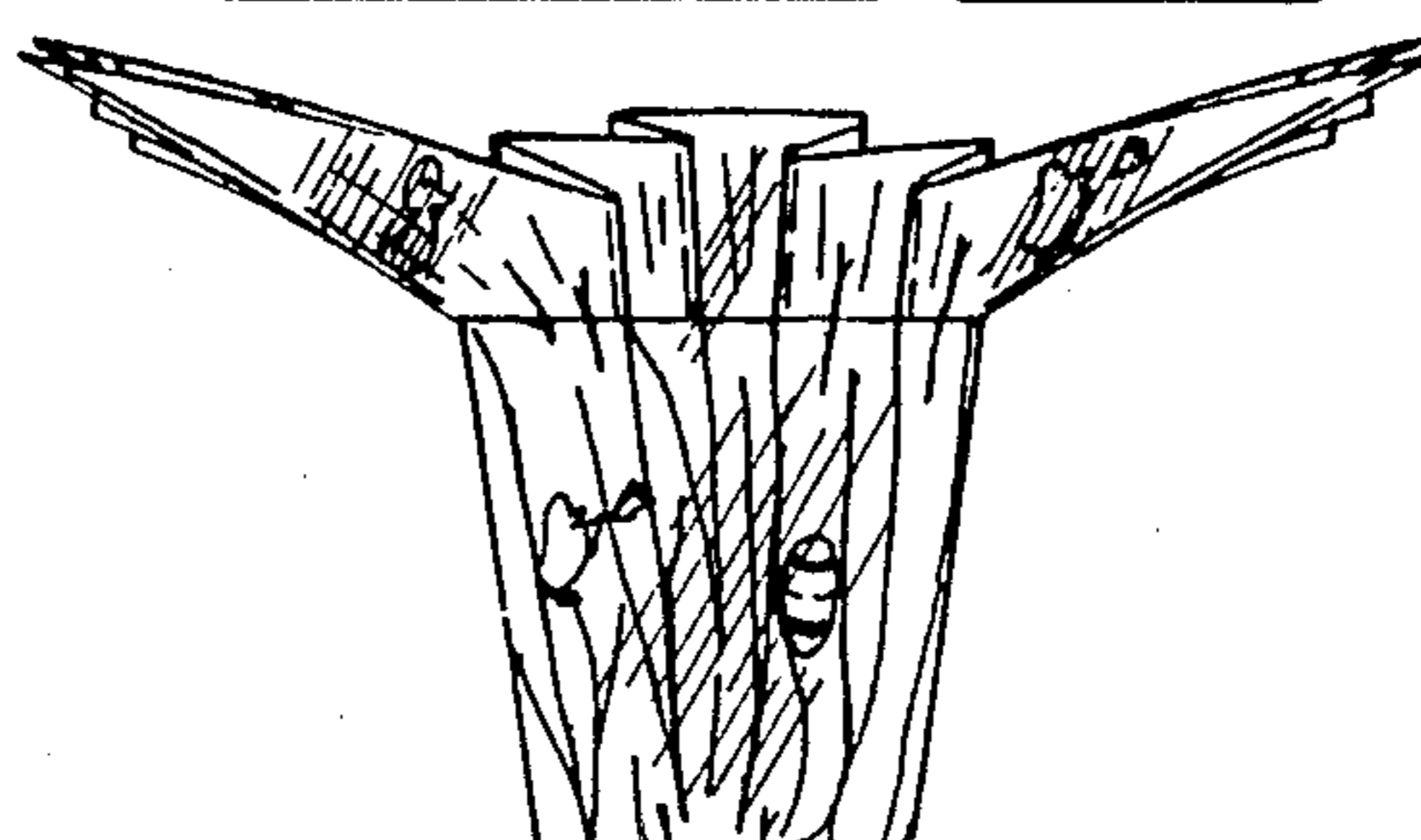
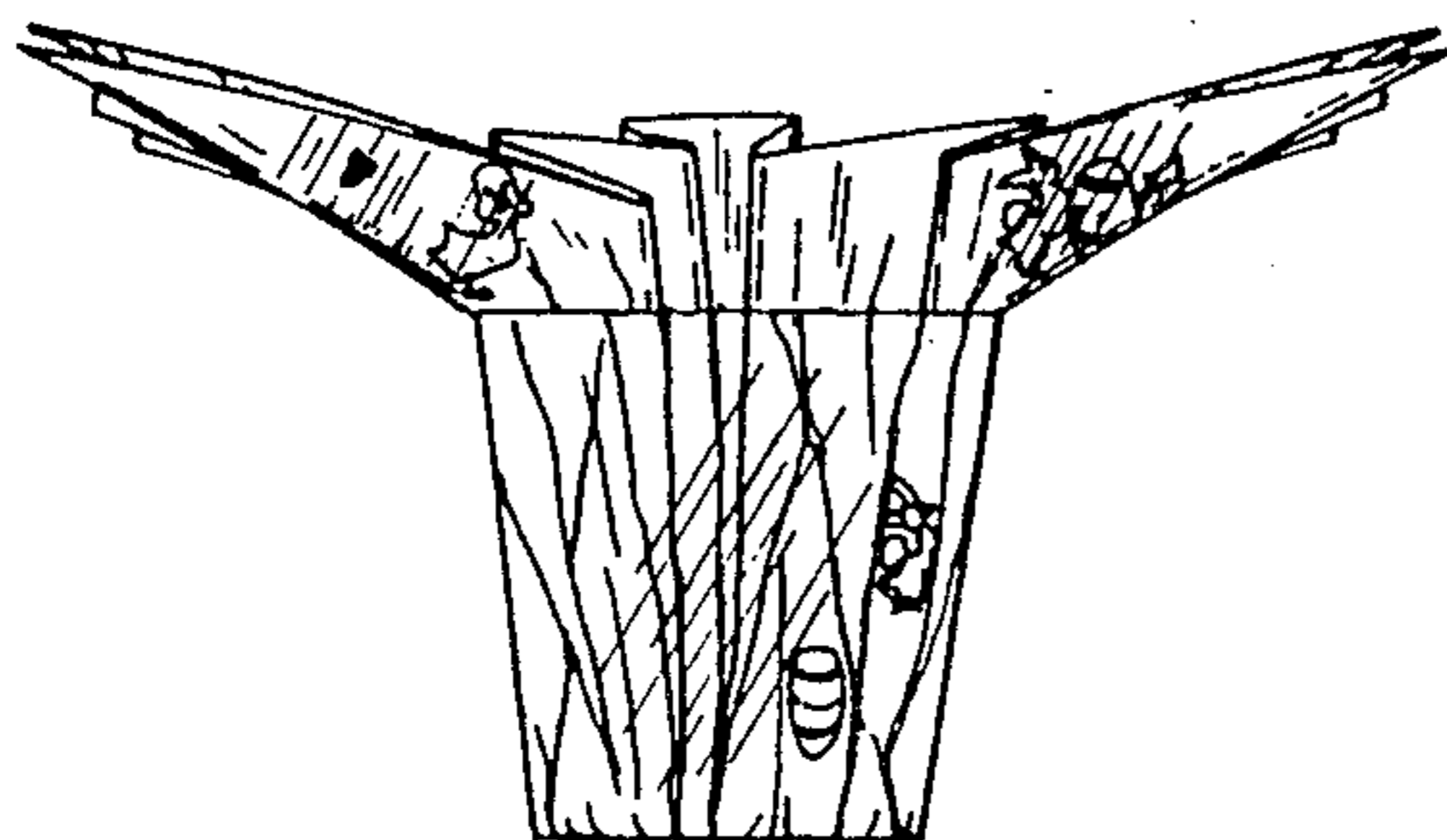
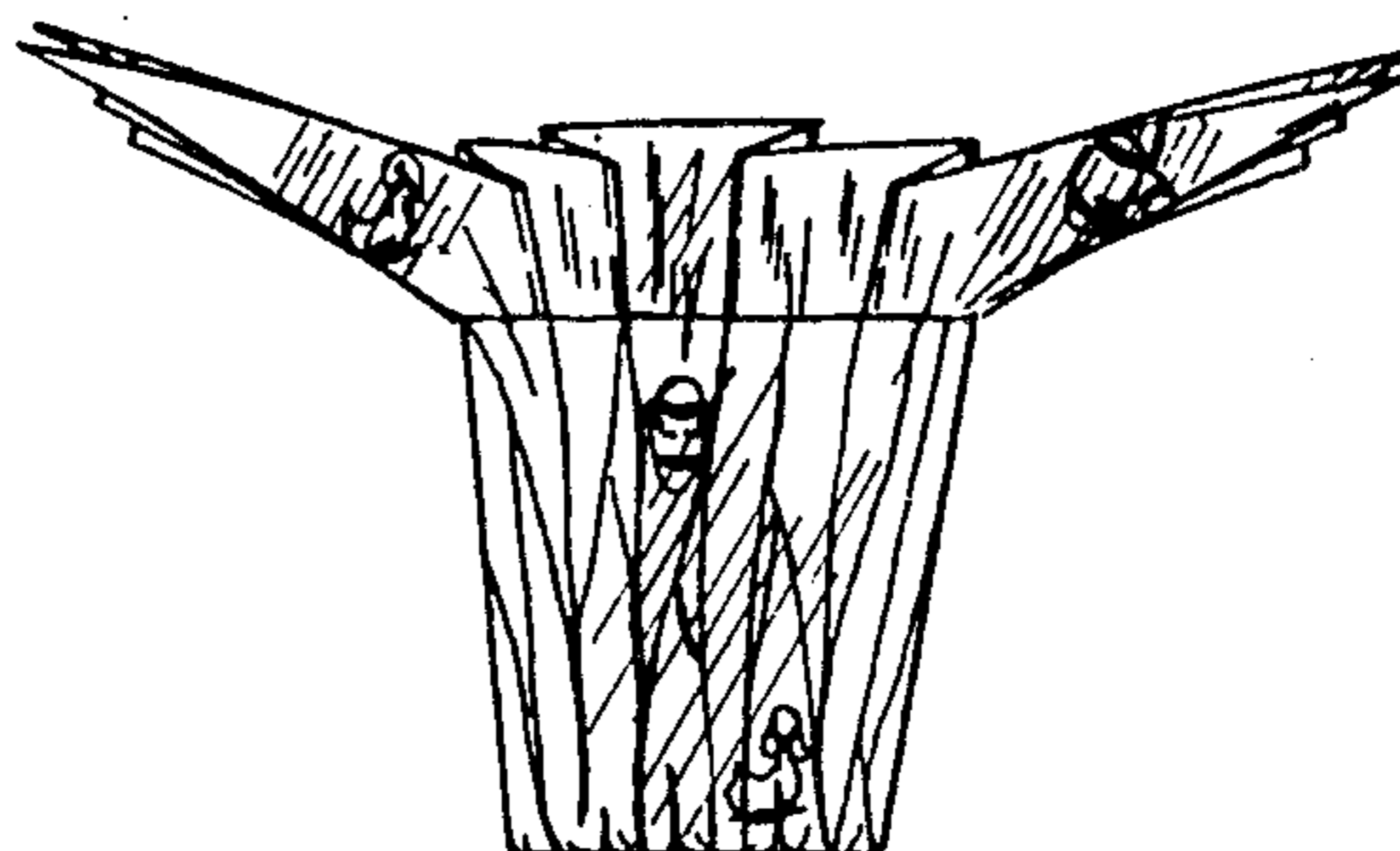
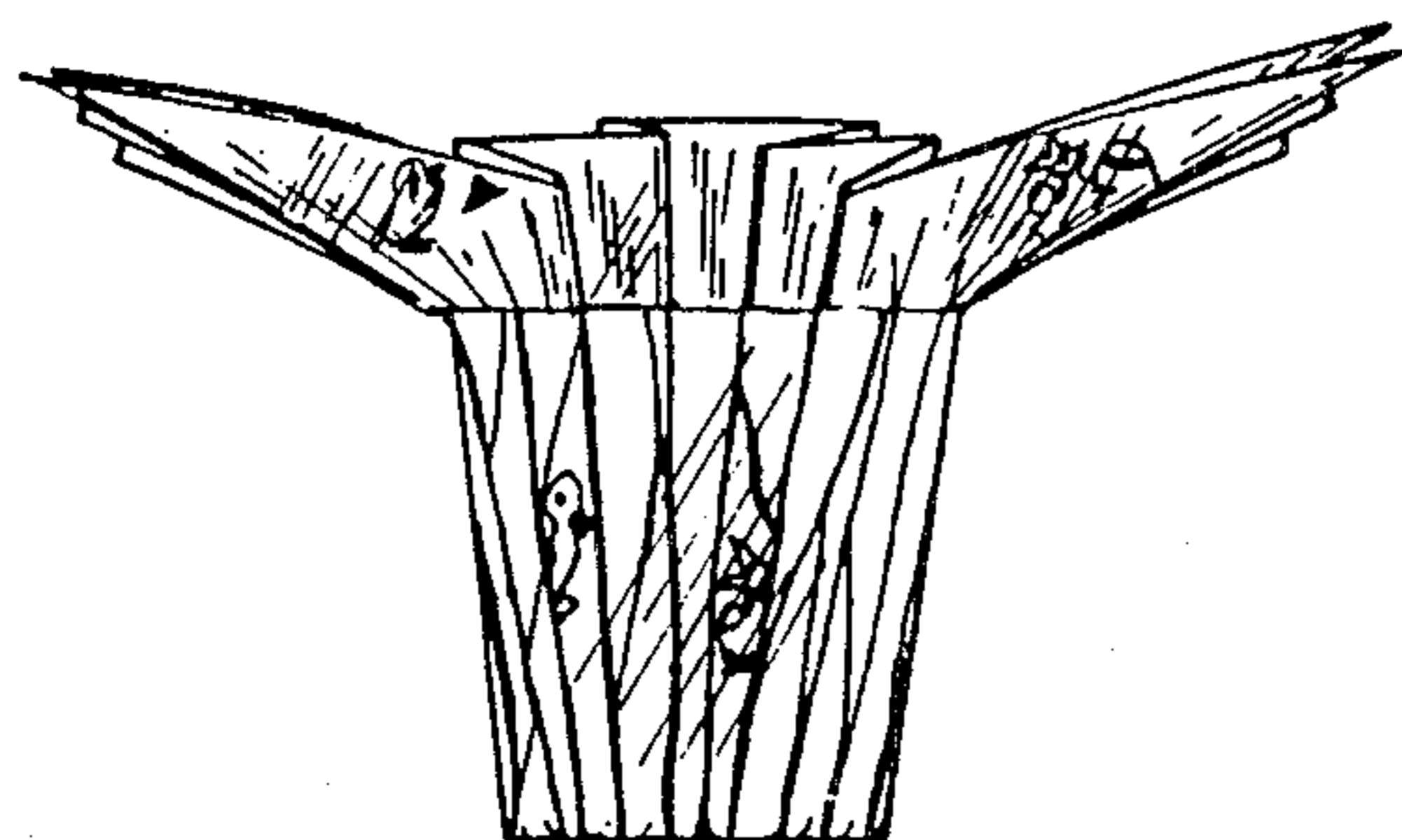
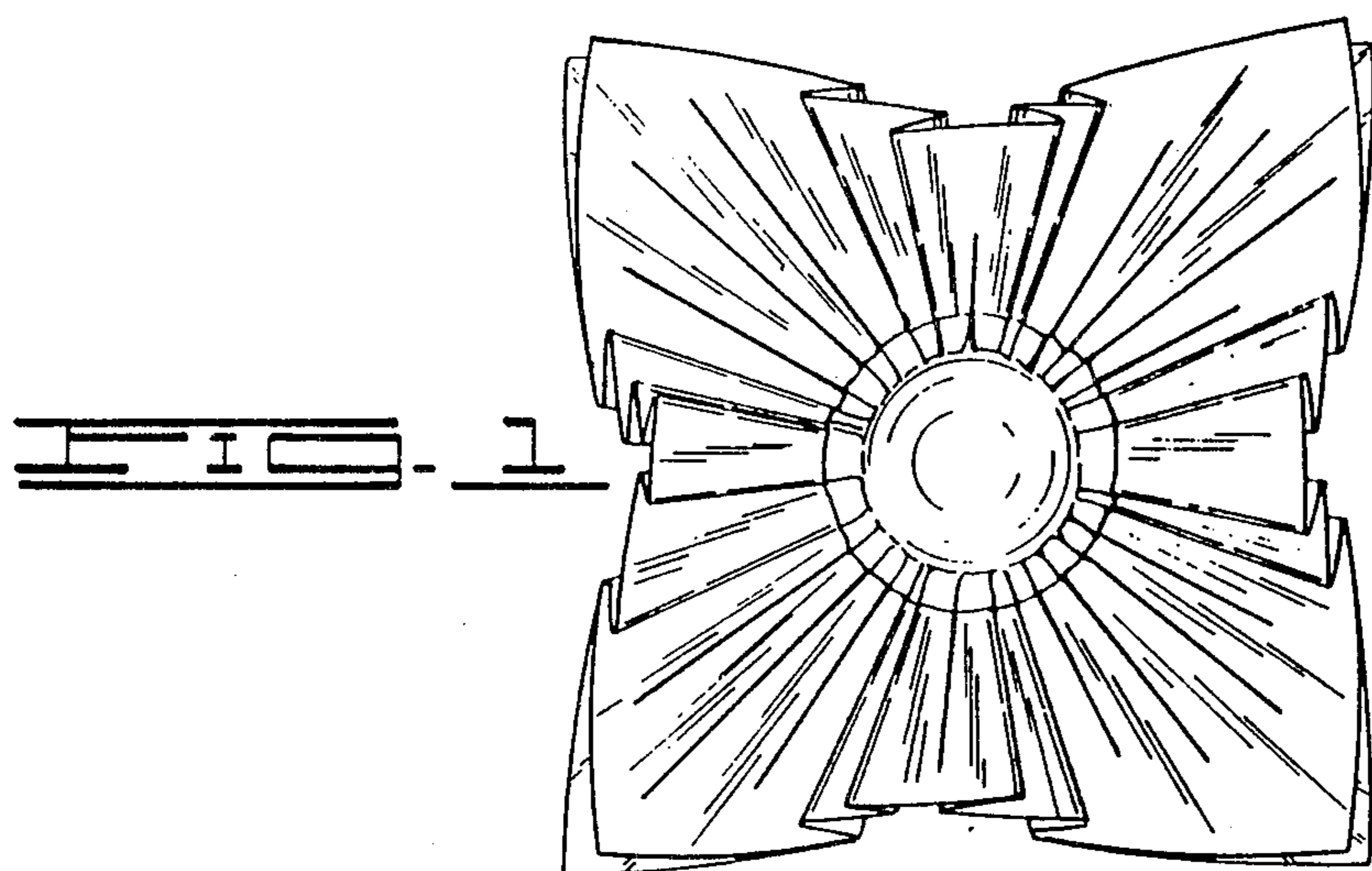

FIG. 4

FIG. 5

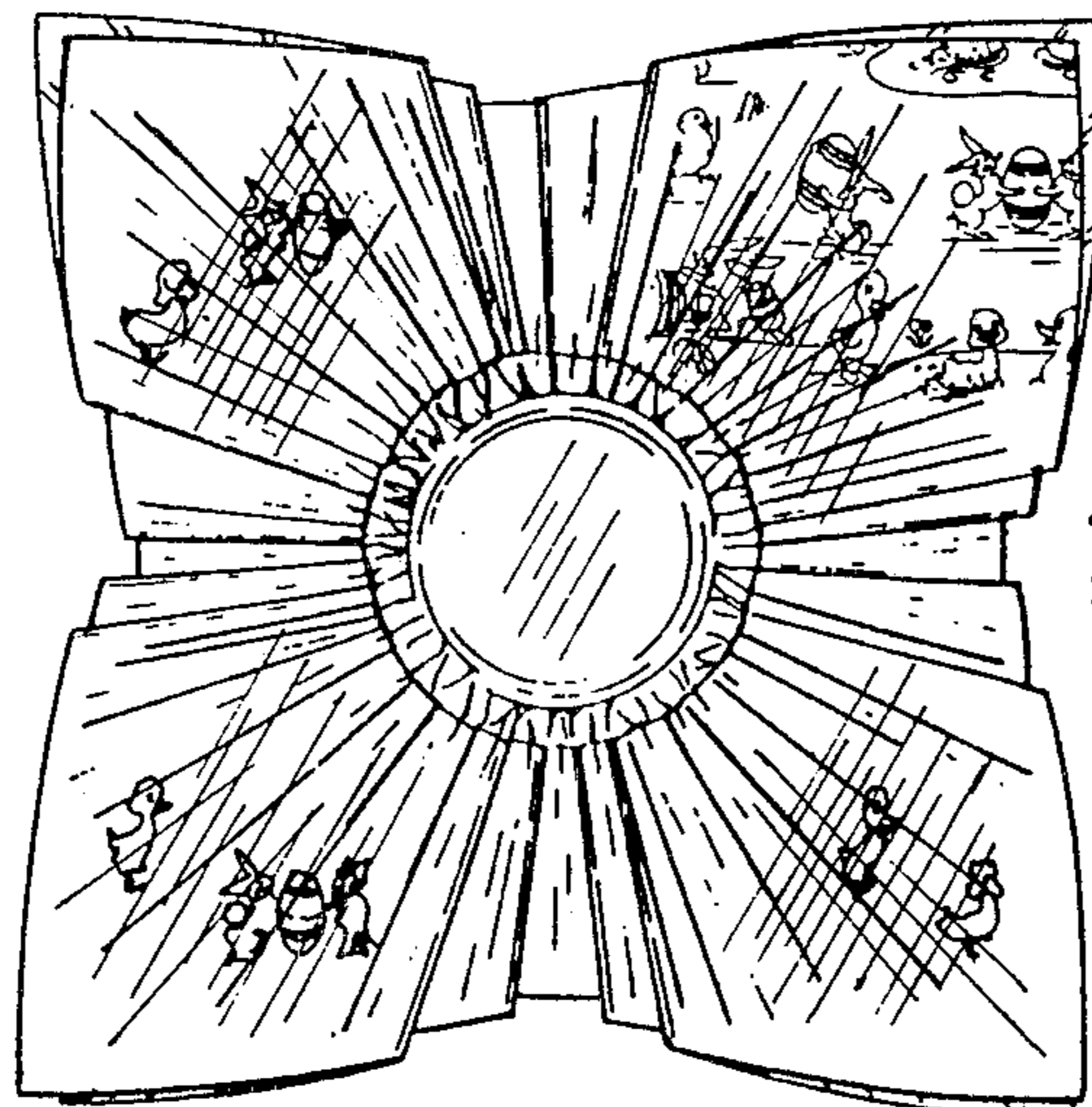

FIG. 6

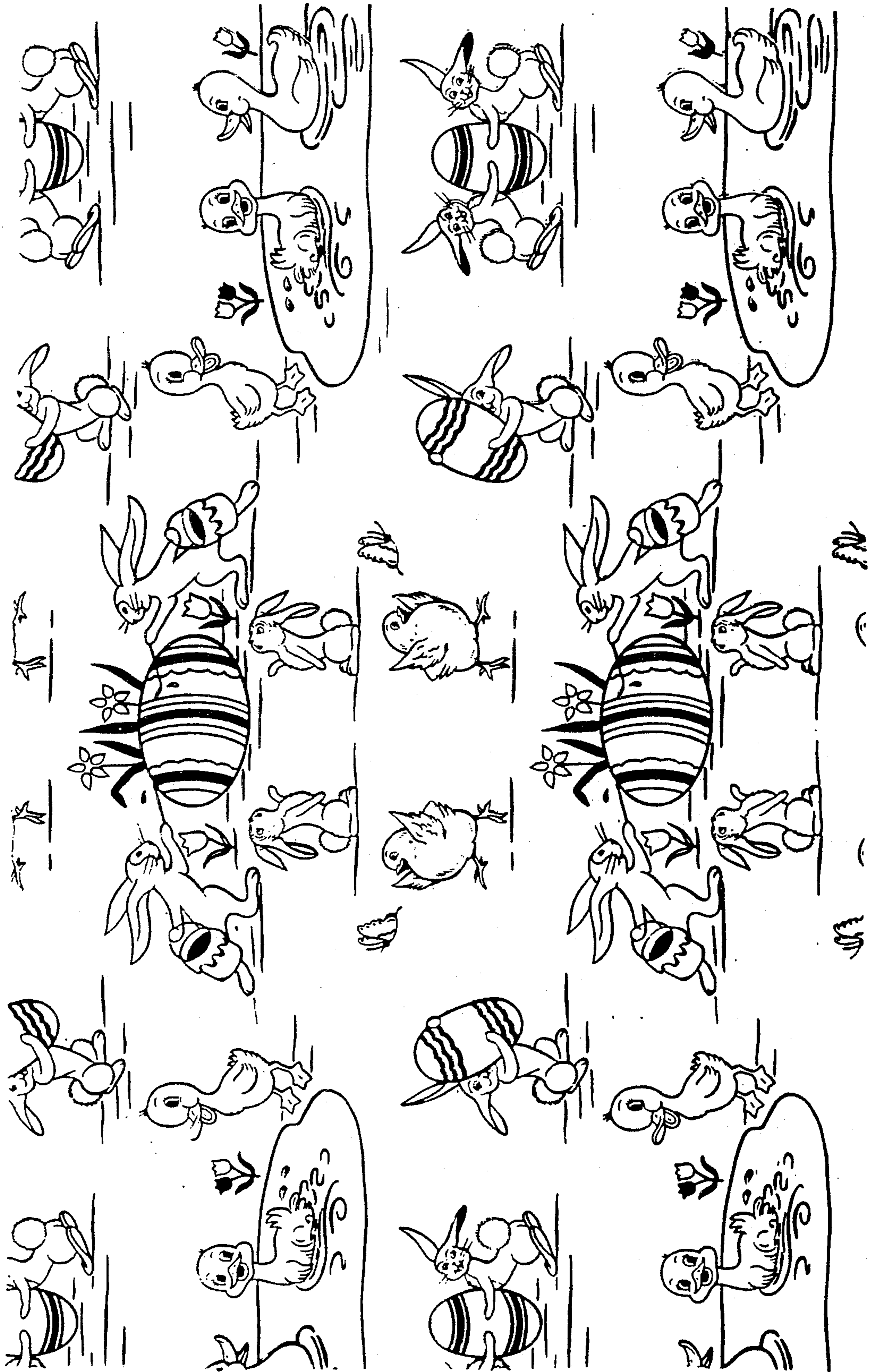

FIG. 7