

[54] **TRAY FOR A HOSPITAL BED**

[76] **Inventor: John J. Delaney, Sr., 8354
Benchmark Rd., Baldwinsville, N.Y.
13027**

[**] **Term: 14 Years**

[21] **Appl. No.: 687,960**

[22] **Filed: Dec. 31, 1984**

[52] **U.S. Cl. D6/511; D6/406**

[58] **Field of Search D6/406, 419, 449, 480,
D6/491, 509, 510, 511; D7/37, 38**

[56] **References Cited**

U.S. PATENT DOCUMENTS

D. 139,017 10/1944 Leatherman D6/406

D. 163,627 6/1951 Paterniti D6/406
D. 274,879 7/1984 Kates D6/495
2,911,108 11/1959 Nield D6/511 X

Primary Examiner—Bruce W. Dunkins
Attorney, Agent, or Firm—Bruns and Wall

[57] **CLAIM**

The ornamental design for a tray for a hospital bed, as shown and described.

DESCRIPTION

FIG. 1 is a perspective view of a tray for a hospital bed embodying my new design;
FIG. 2 is a top plan view thereof;
FIG. 3 is a front elevation thereof;
FIG. 4 is a left side view thereof;
FIG. 5 is a right side view thereof; and
FIG. 6 is a bottom view thereof.

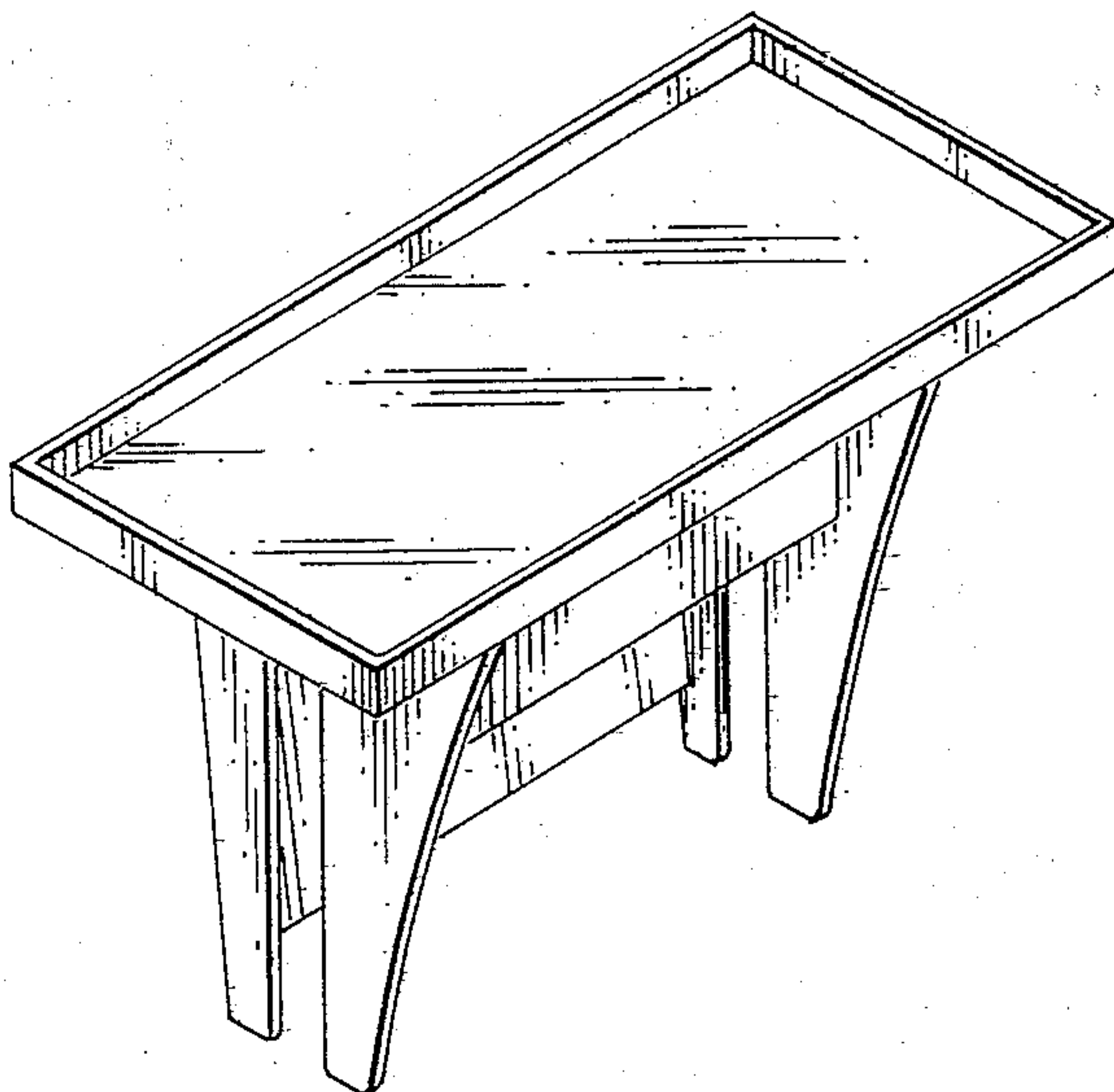

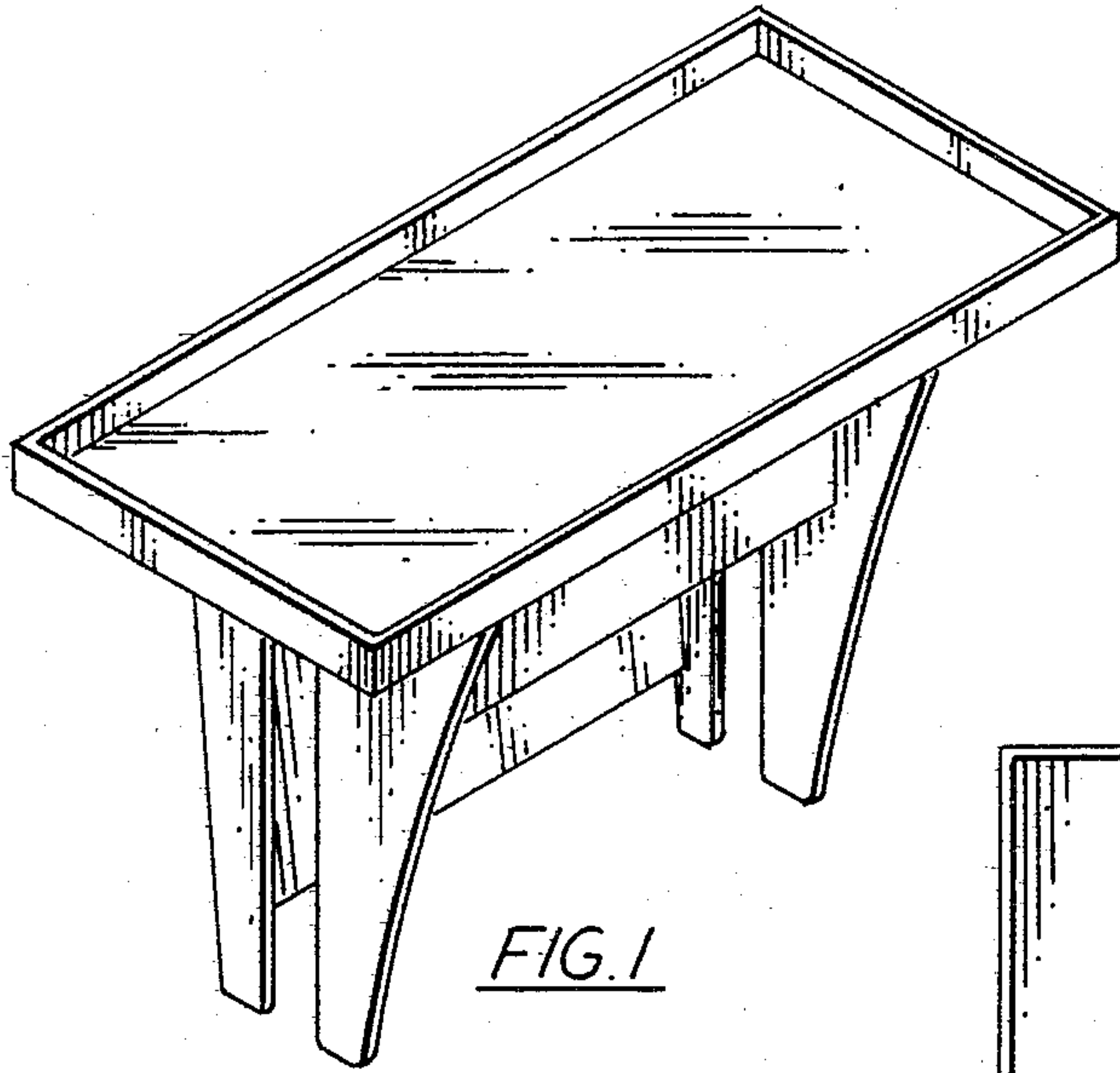

FIG. 1

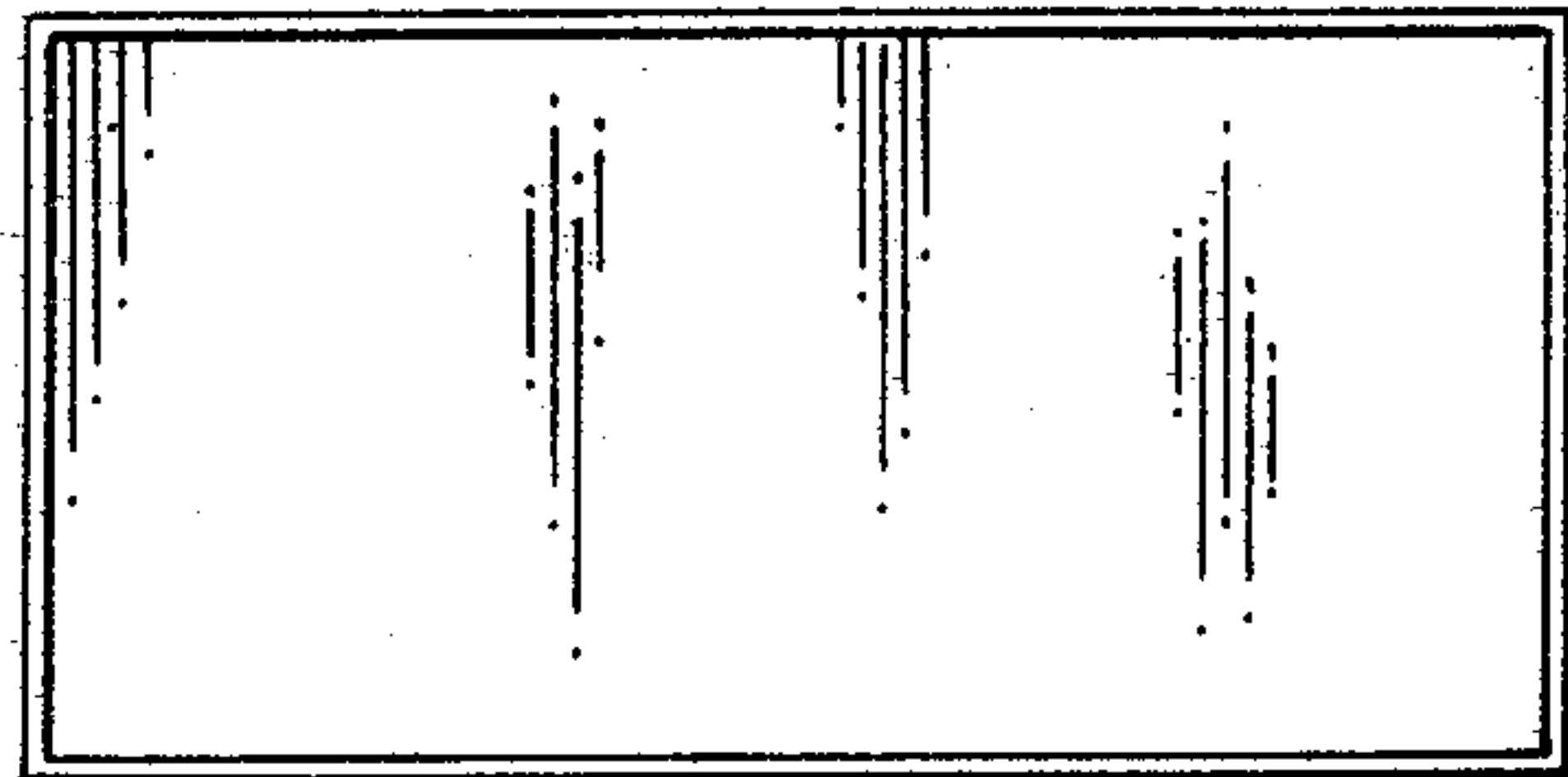

FIG. 2

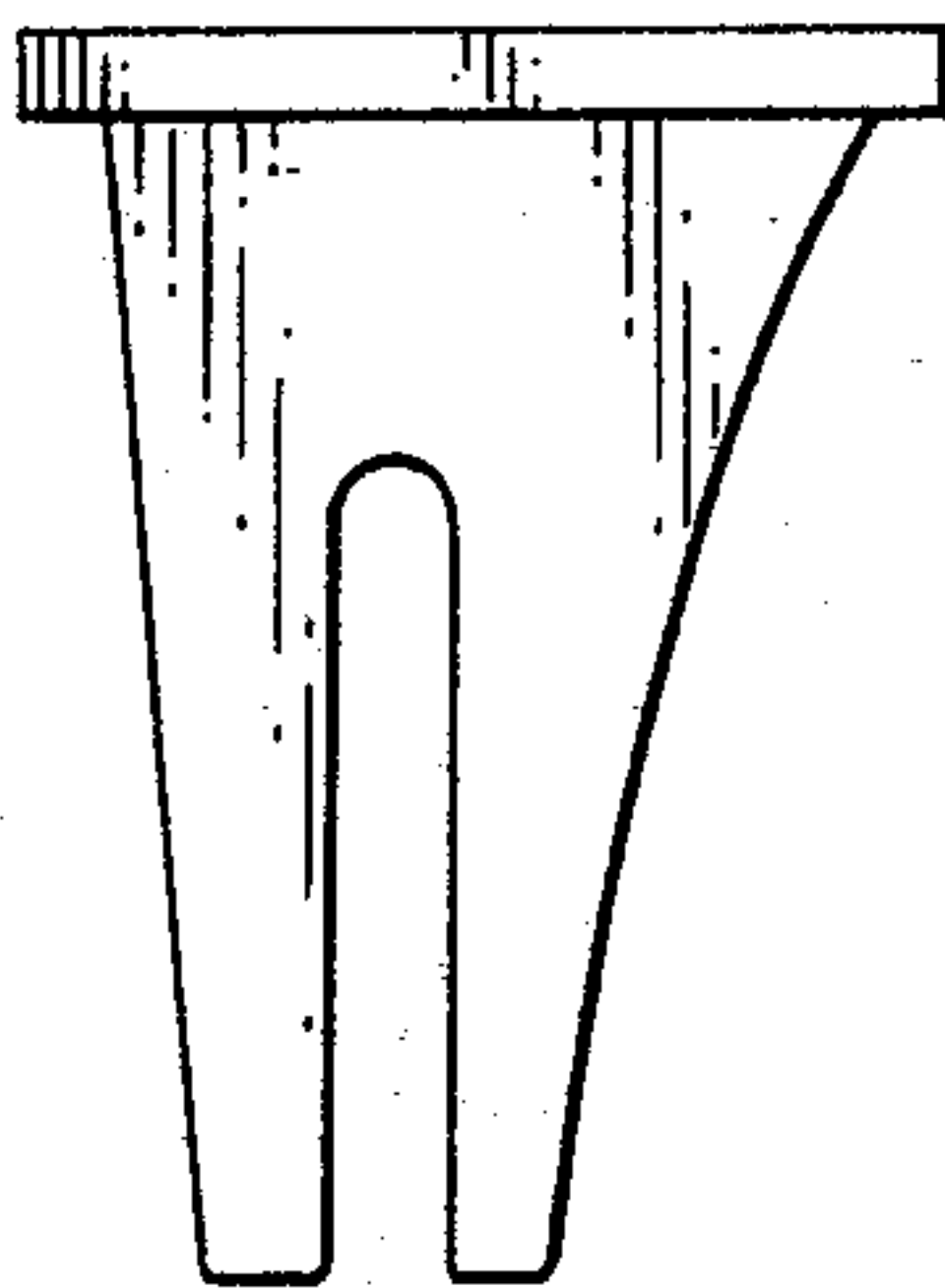

FIG. 4

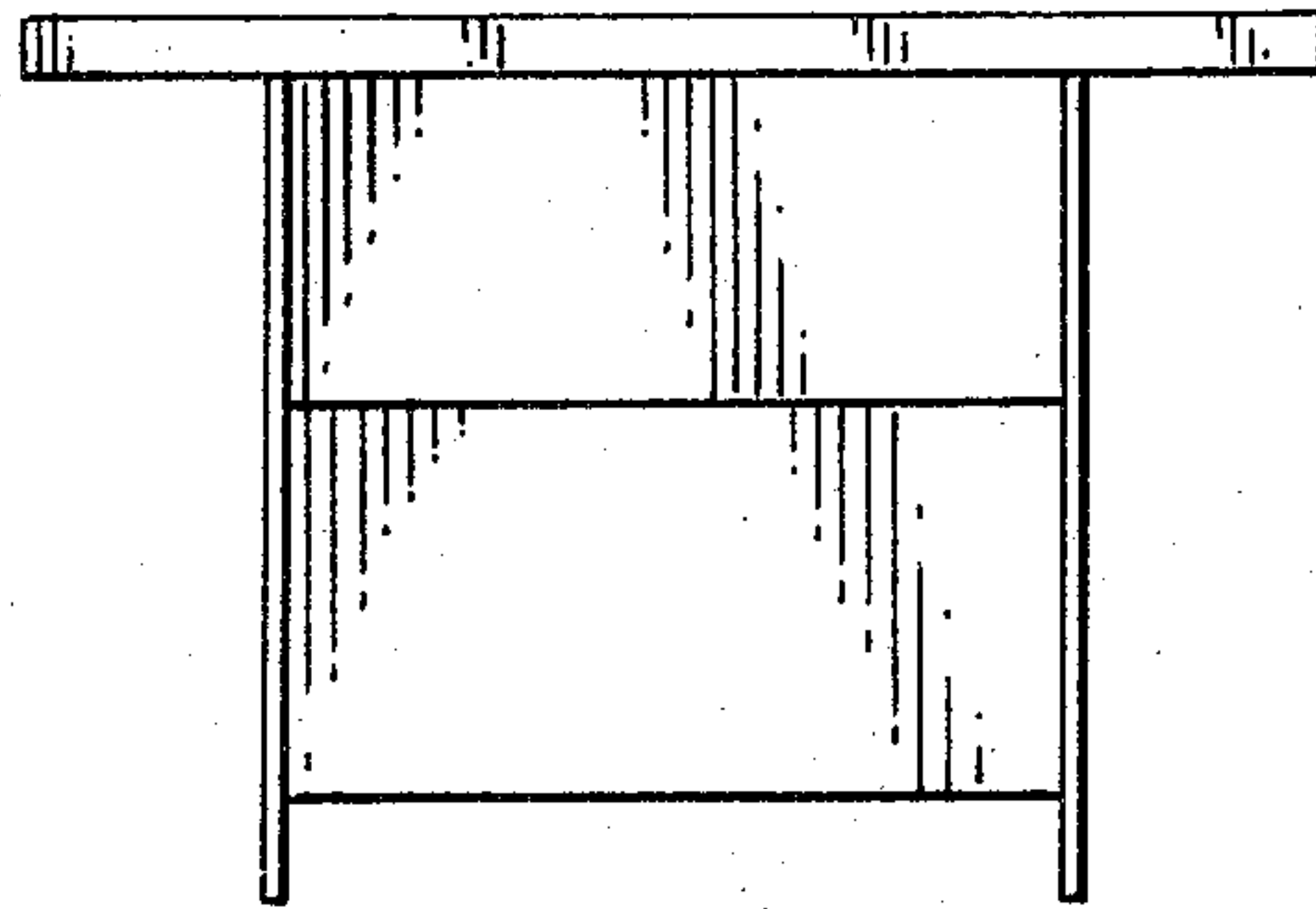

FIG. 3

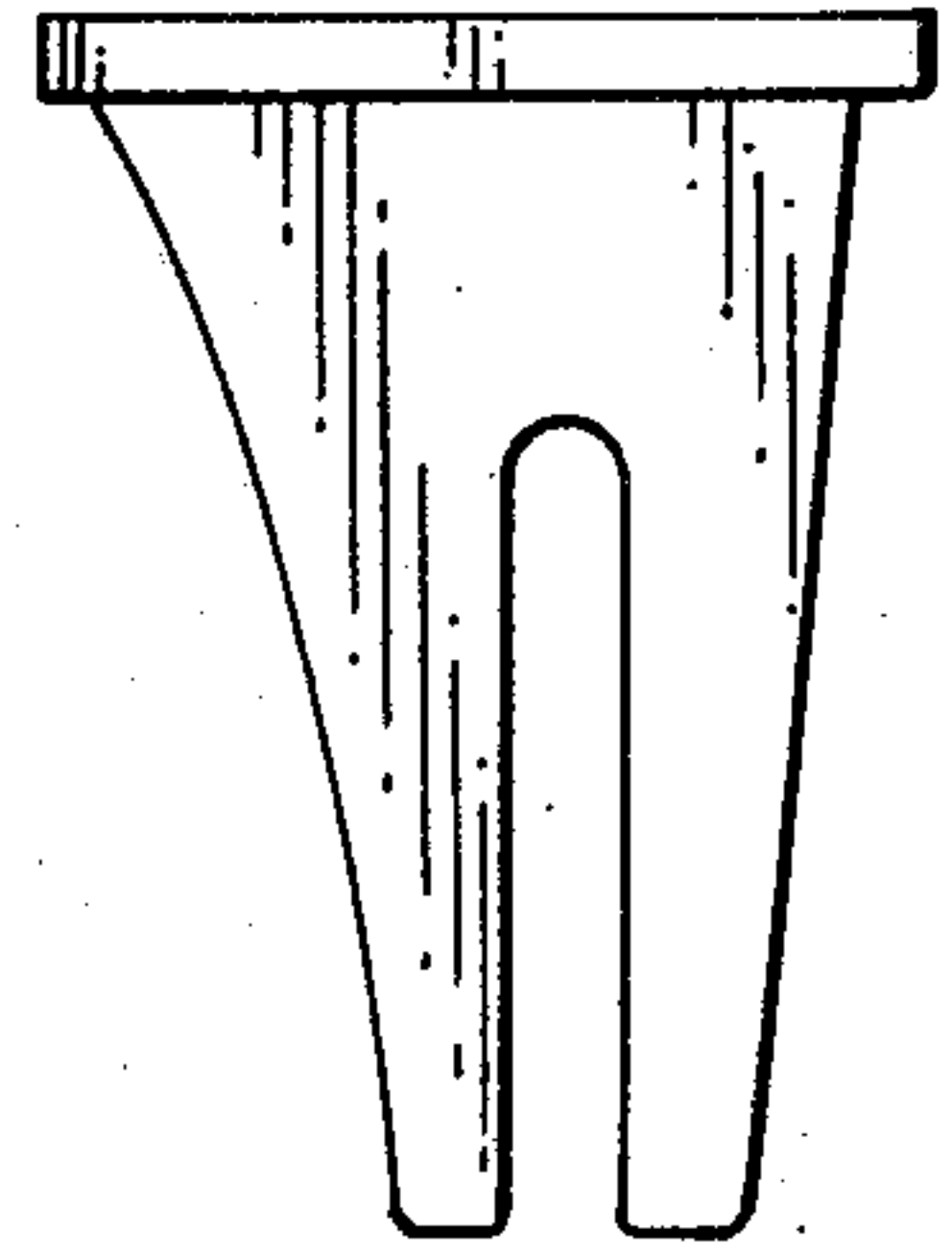

FIG. 5

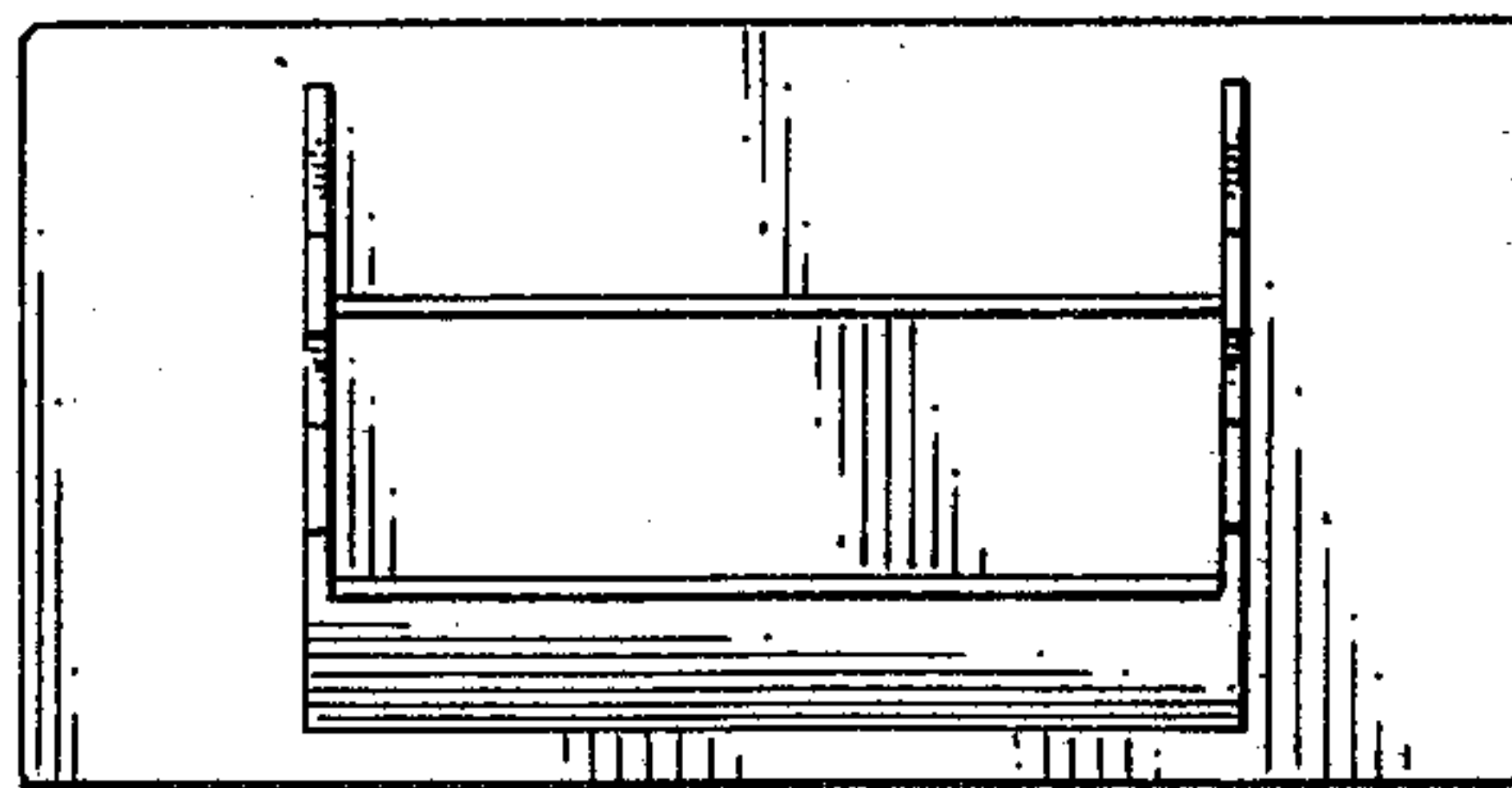

FIG. 6