

[54] PROTECTION HOUSING FOR TELECOMMUNICATION EQUIPMENT OR THE LIKE

[75] Inventors: Thomas J. Smith, Bay Shore; Ronald C. Urban, Bellerose, both of N.Y.

[73] Assignee: TII Industries, Inc., Copiague, N.Y.

[**] Term: 14 Years

[21] Appl. No.: 695,612

[22] Filed: Jan. 28, 1985

[52] U.S. Cl. D13/41

[58] Field of Search D13/12, 35, 40-41, D13/99; 361/332, 356, 390, 391, 119; 269/903; 339/14 R, 147 R, 198 R

[56] References Cited

U.S. PATENT DOCUMENTS

D. 106,981	11/1937	Kelly	D13/11
D. 251,485	4/1979	Stockdale	D13/40
D. 254,846	4/1980	Wood	D13/40
D. 260,878	9/1981	Dolinar et al.	D13/13

OTHER PUBLICATIONS

IBM Tech. Disclosure Bulletin, vol. 22, No. 4, 9/1979, FIG. 1.

Primary Examiner—Wallace R. Burke
Assistant Examiner—Ruth Takemoto
Attorney, Agent, or Firm—Sachs & Sachs

[57] CLAIM

The ornamental design for a protection housing for telecommunication equipment or the like, substantially as shown and described.

DESCRIPTION

FIG. 1 is a front perspective view of a protection housing for telecommunication equipment or the like in a closed position showing our new design; FIG. 2 is a front elevational view thereof; FIG. 3 is a rear elevational view thereof; FIG. 4 is a right side elevational view thereof; FIG. 5 is a left side elevational view thereof; FIG. 6 is a top plan view thereof; FIG. 7 is a bottom plan view thereof; and FIG. 8 is an exploded view thereof with the cap in an open position.

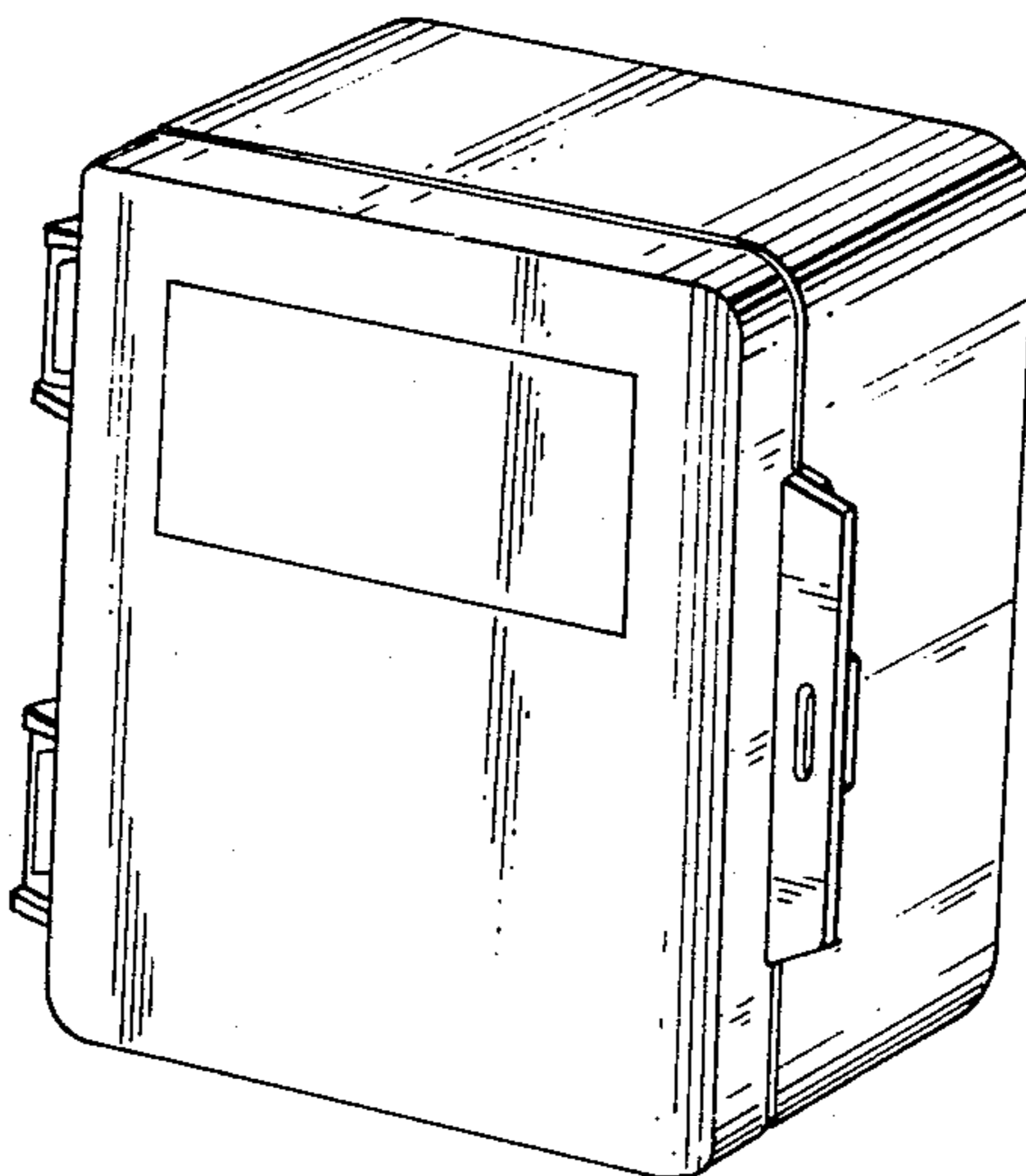

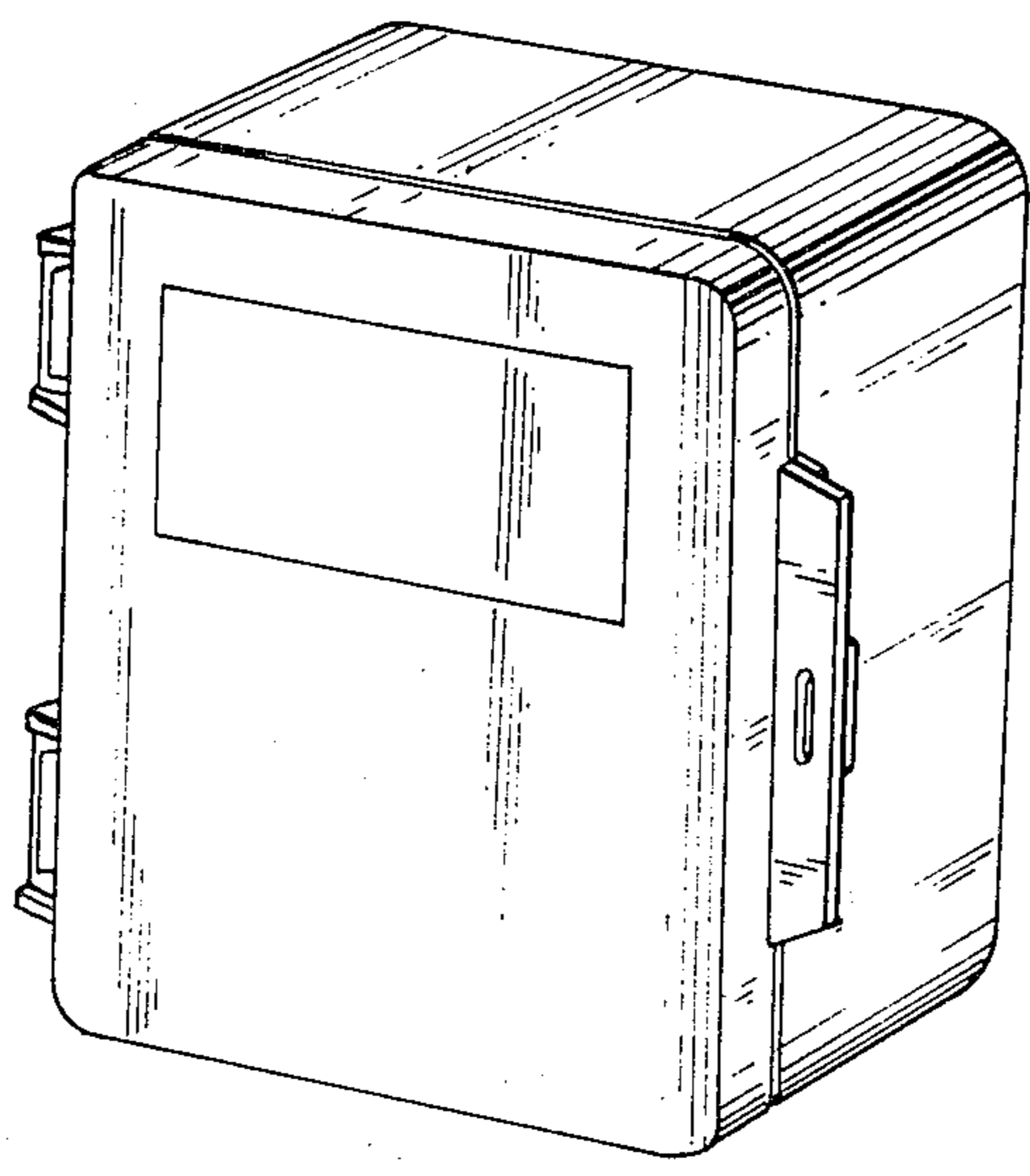

Figure 1

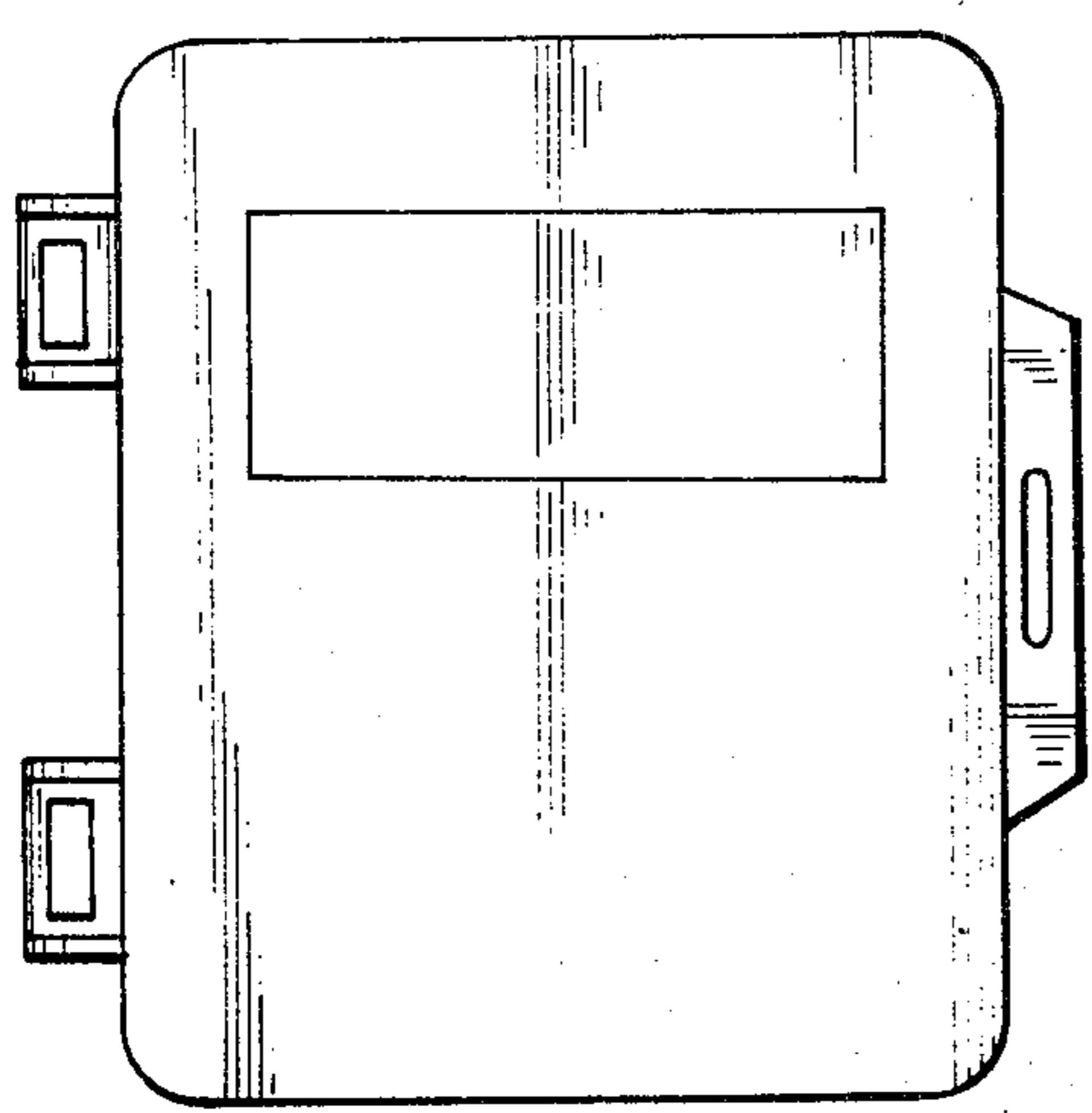

Figure 2

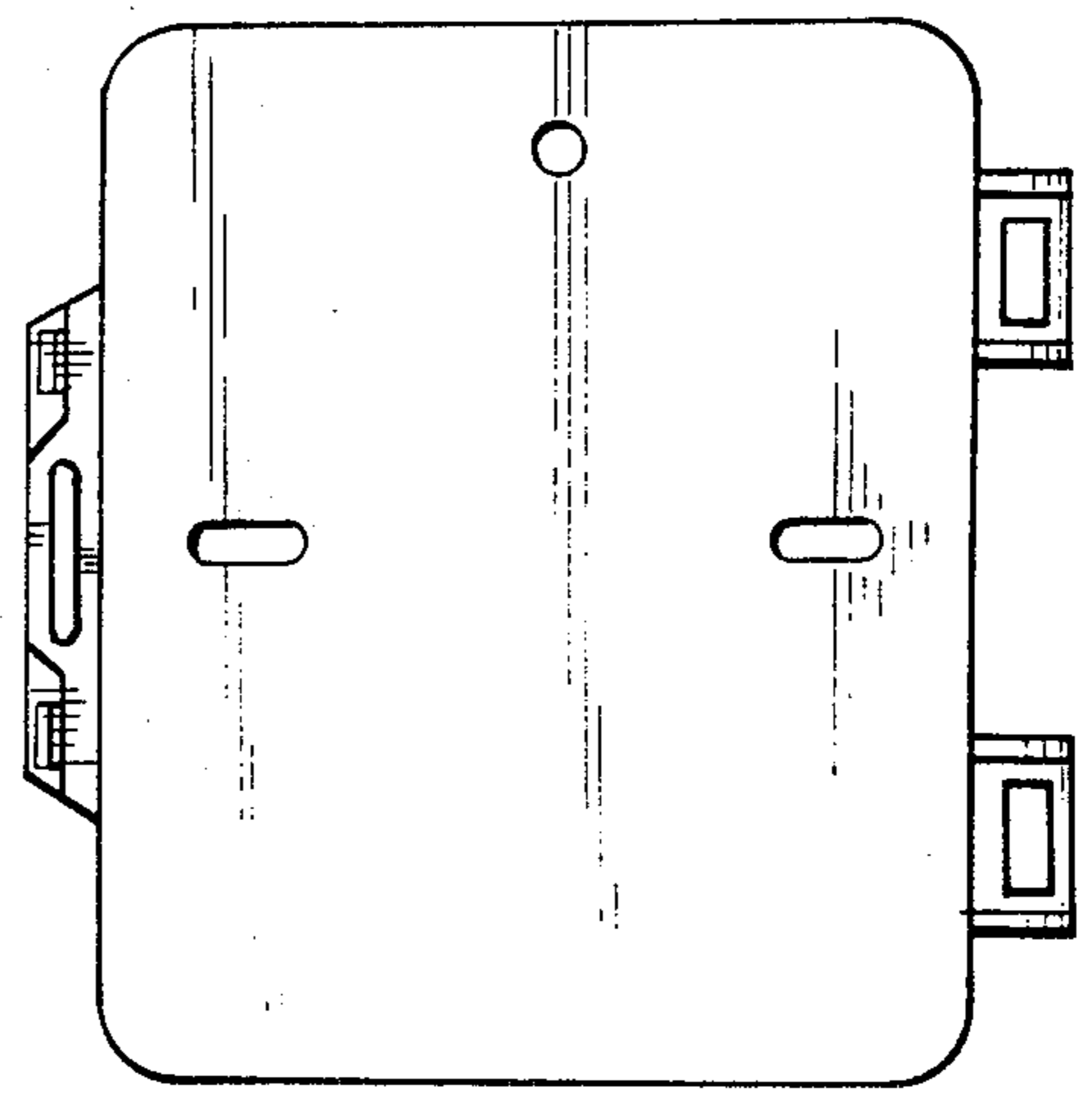

Figure 3

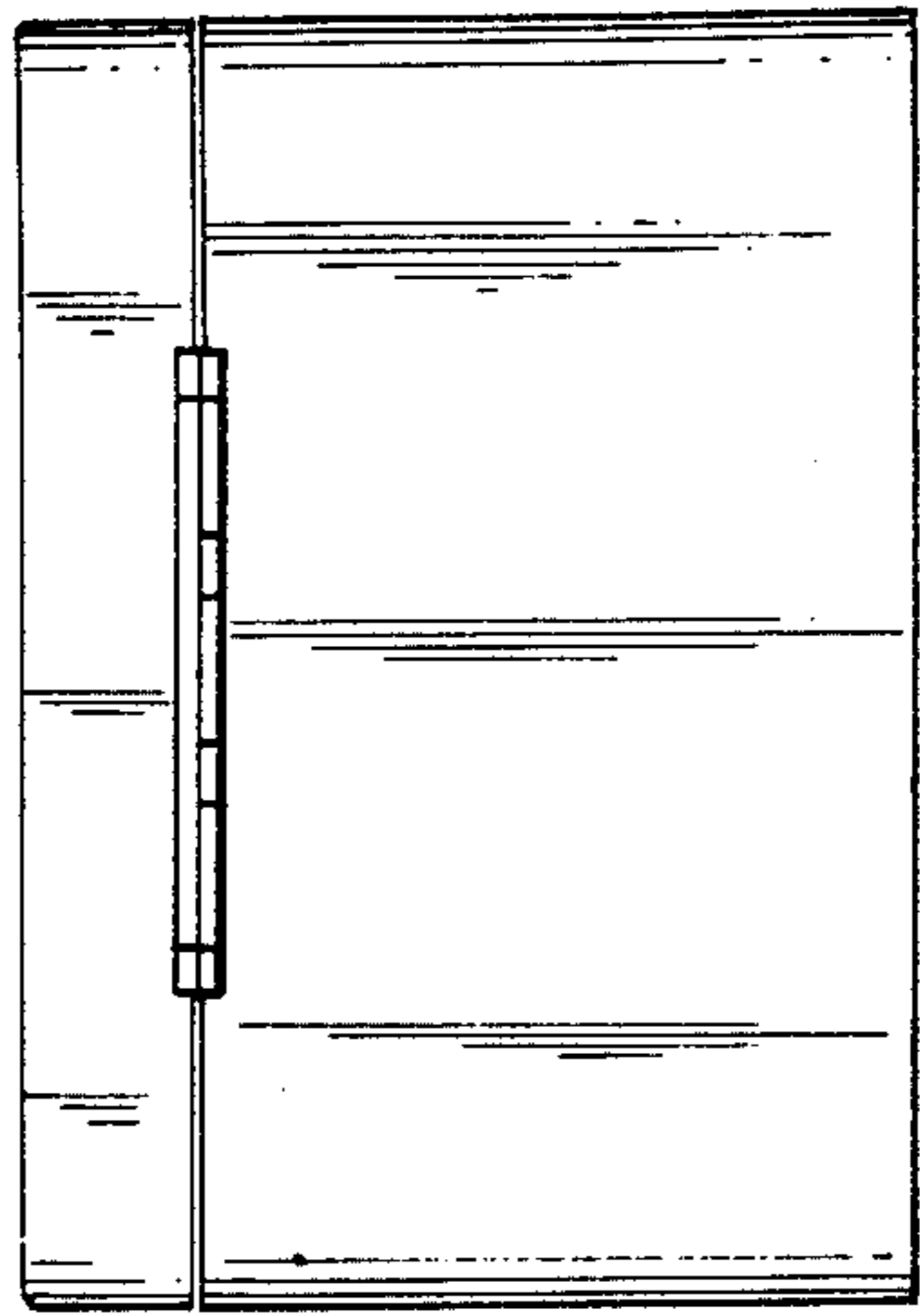

Figure 4

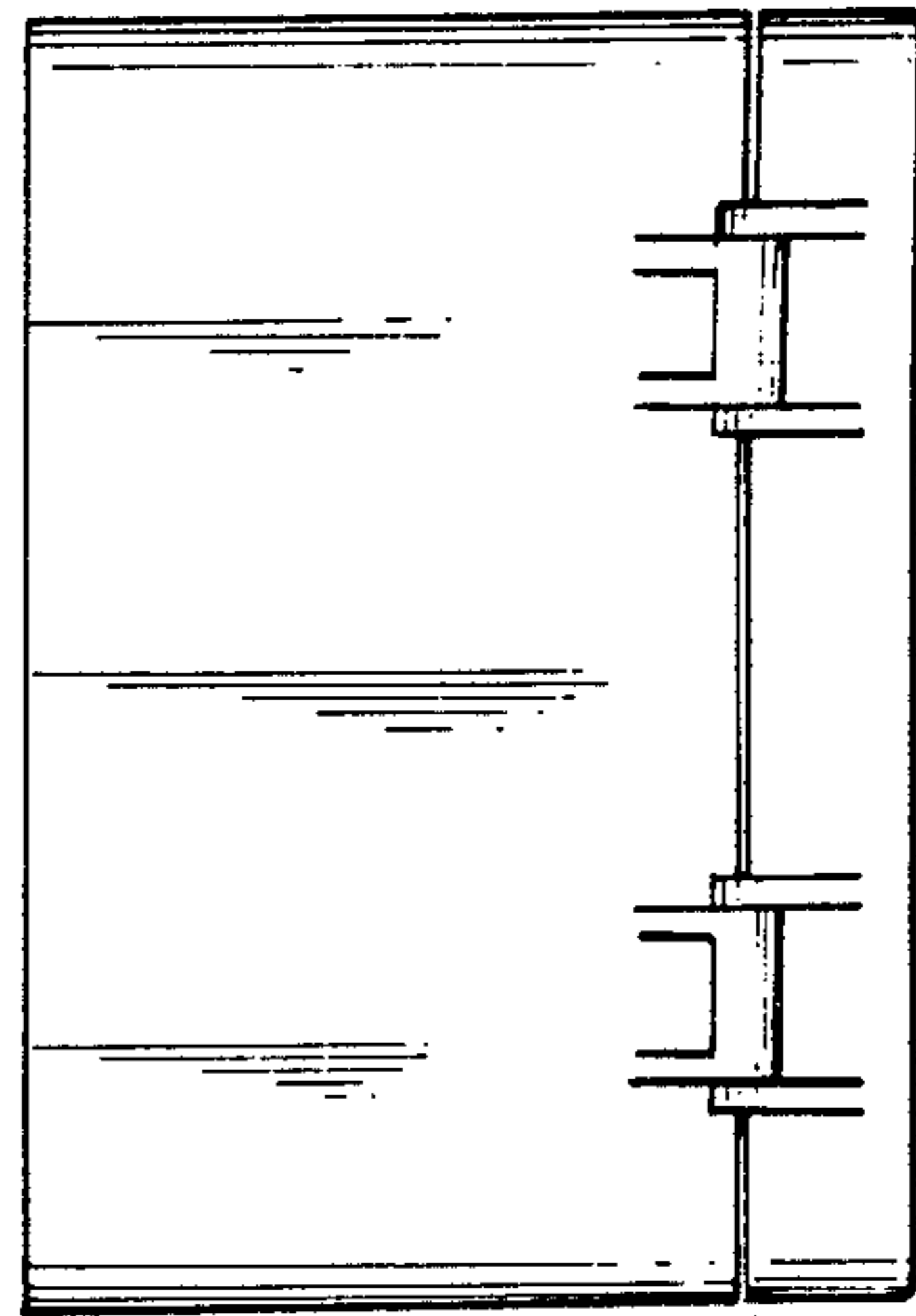

Figure 5

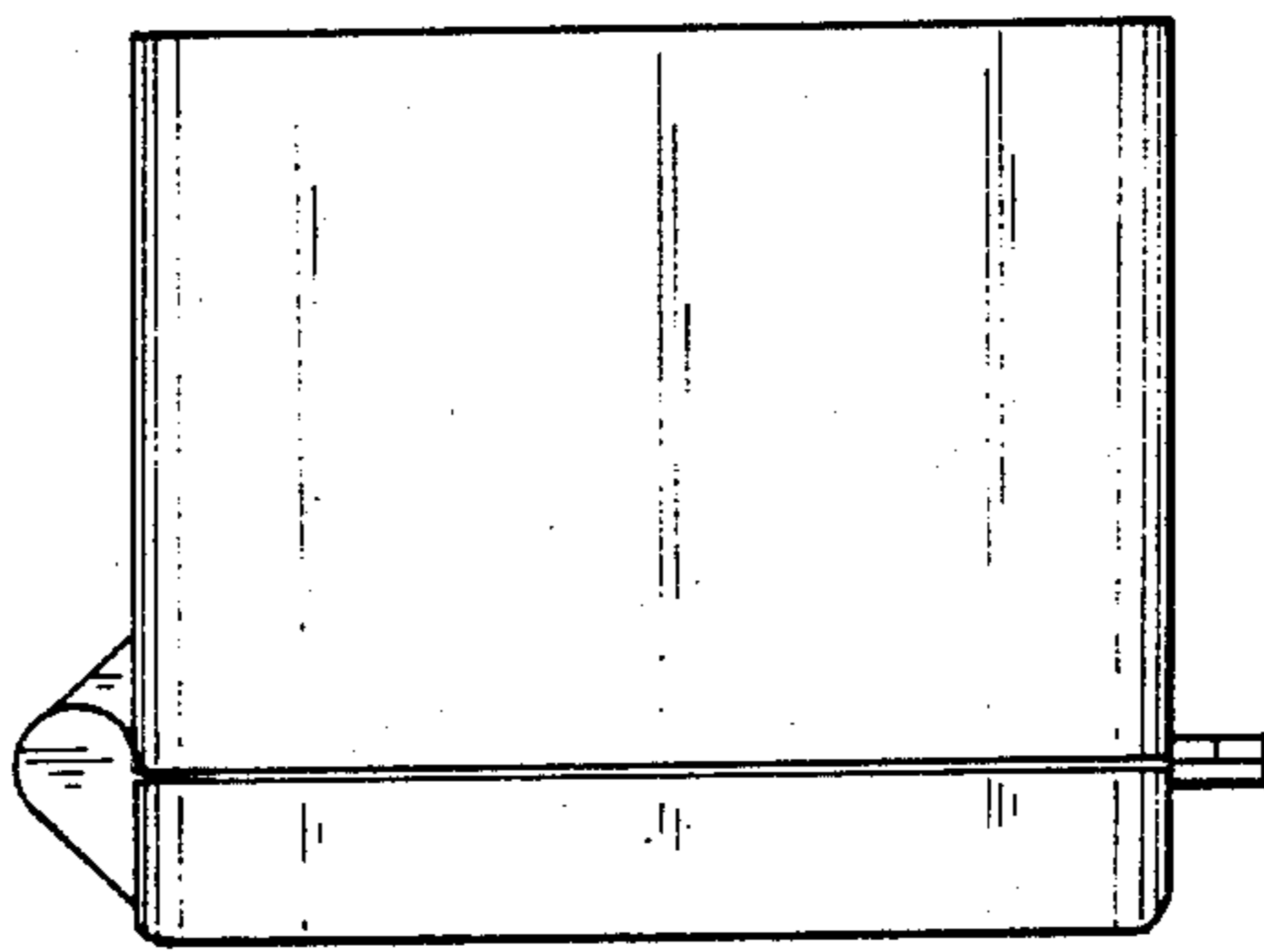

Figure 6

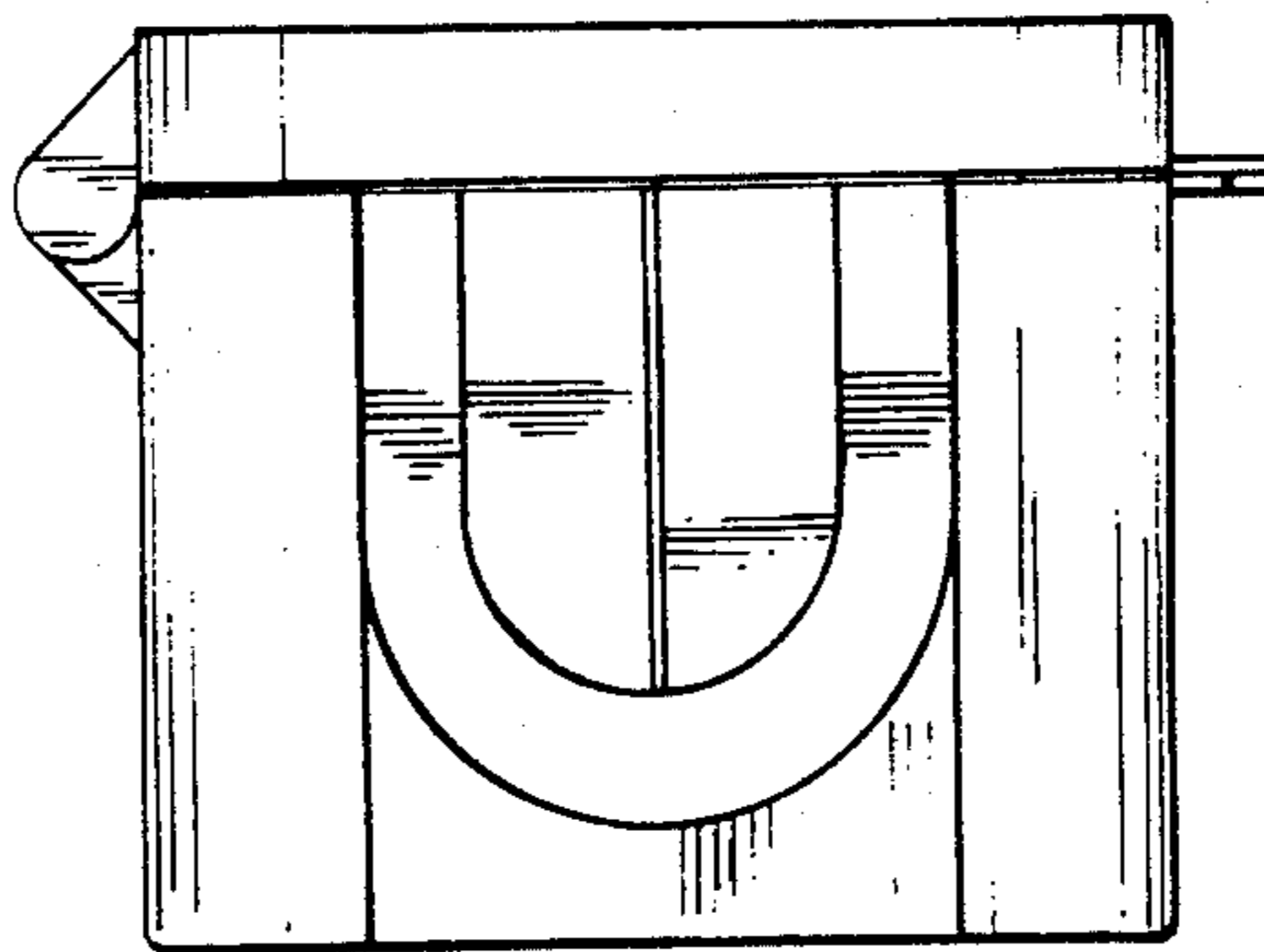

Figure 7

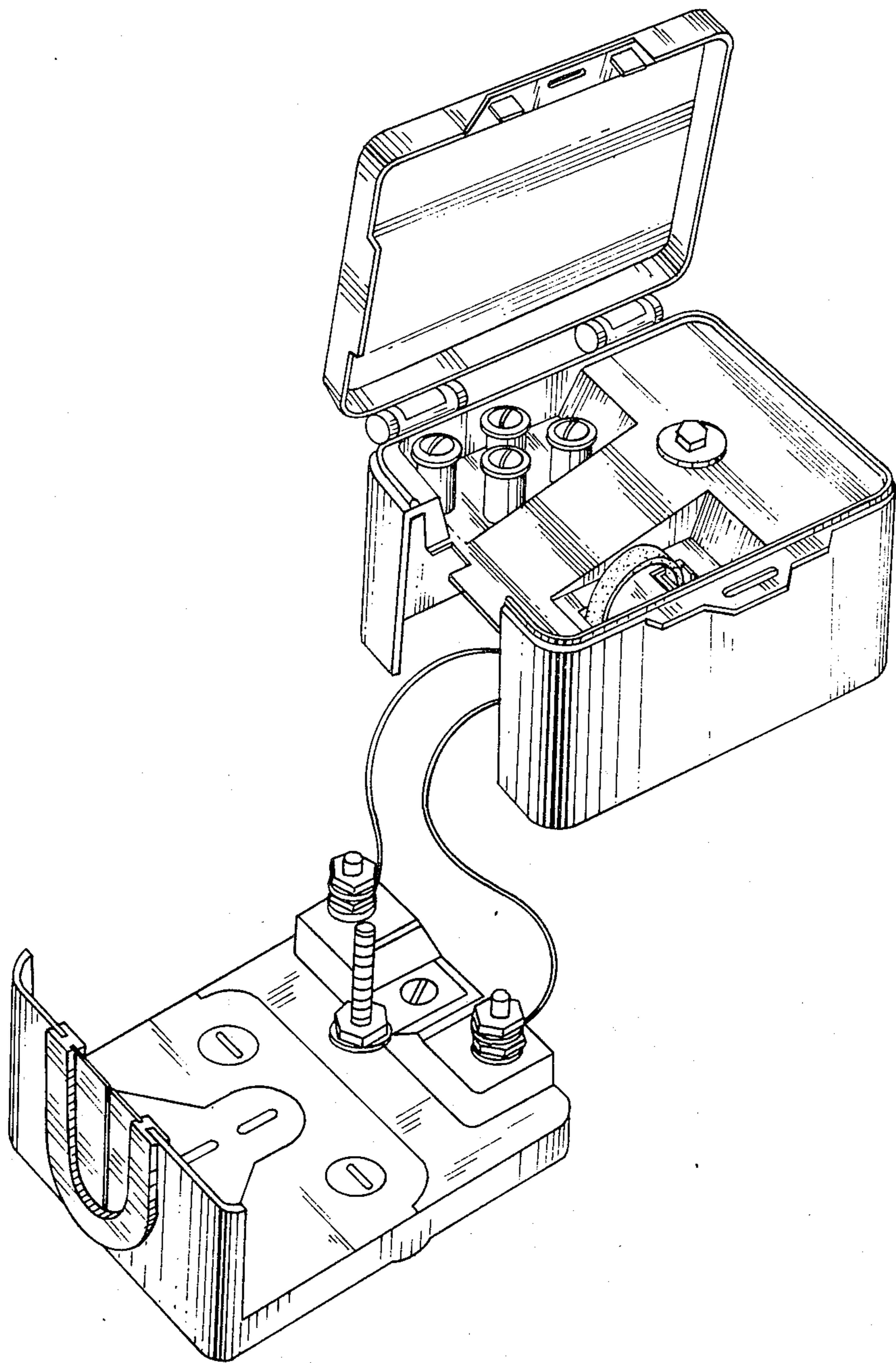

Figure 8