

[54] FOLDING GOLF CART

[76] Inventor: Ming-Chih Hsieh, 6F-3, 67, Sung-Chiang Rd., Taipei, Taiwan

[\*\*] Term: 14 Years

[21] Appl. No.: 728,697

[22] Filed: Apr. 29, 1985

[52] U.S. Cl. .... D34/15

[58] Field of Search ..... D34/15, 24; 280/DIG. 6, 280/DIG. 5; 180/11, 19.1, 19.2, 65.6

[56] References Cited

U.S. PATENT DOCUMENTS

2,791,436	5/1957	Wuerthner	.....	D34/15
2,806,709	9/1957	Watson	.....	D34/15
2,914,336	11/1959	Hibben, Jr. et al.	.....	D34/15
3,561,555	2/1971	Carmichael	.....	180/19.2
3,948,332	4/1976	Tyner	.....	180/65.6

Primary Examiner—James M. Gandy  
Assistant Examiner—Kay H. Chin  
Attorney, Agent, or Firm—Lowe, Price, LeBlanc, Becker & Shur

[57] CLAIM

The ornamental design for a folding golf cart, substantially as shown and described.

DESCRIPTION

FIG. 1 is a perspective view of a folding golf cart showing my new design, in its folded condition; FIG. 2 is a front elevation view thereof; FIG. 3 is a rear elevation view thereof; FIG. 4 is a right side elevation view thereof; FIG. 5 is a left side elevation view thereof; FIG. 6 is a top plan view thereof; FIG. 7 is a bottom plan view thereof; and FIG. 8 is an another perspective view thereof, in its expanded condition.

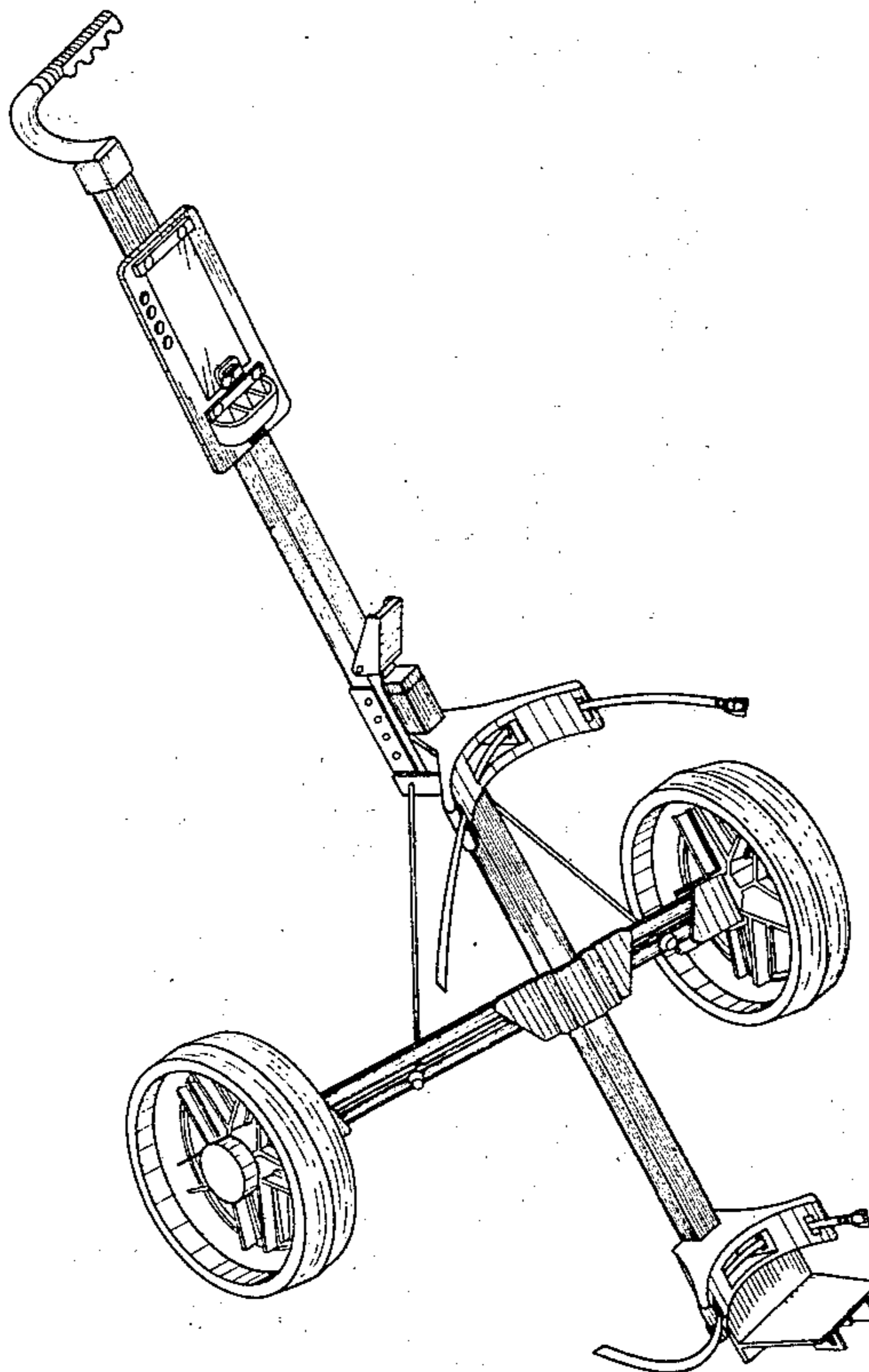

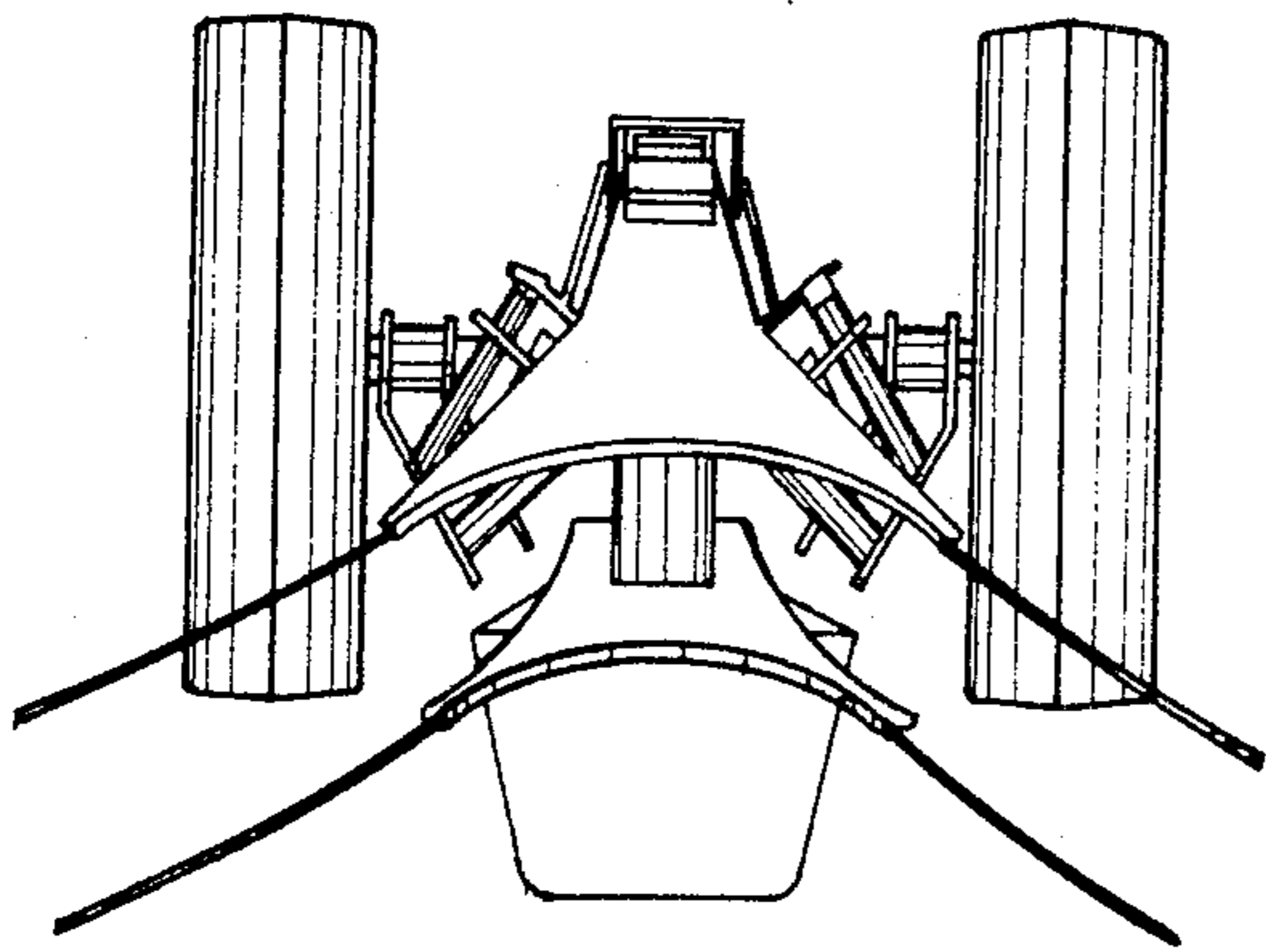

FIG. 6

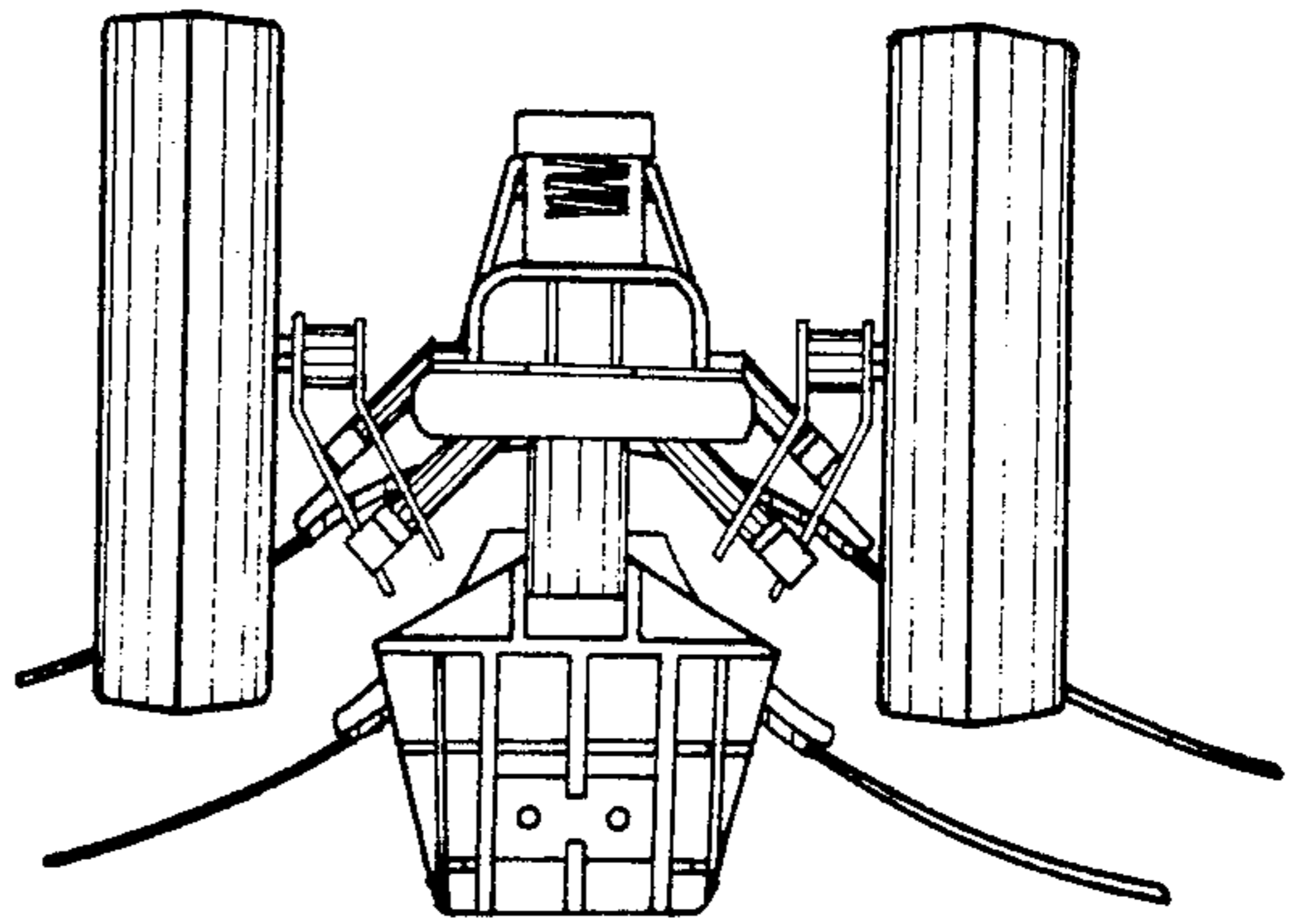

FIG. 7

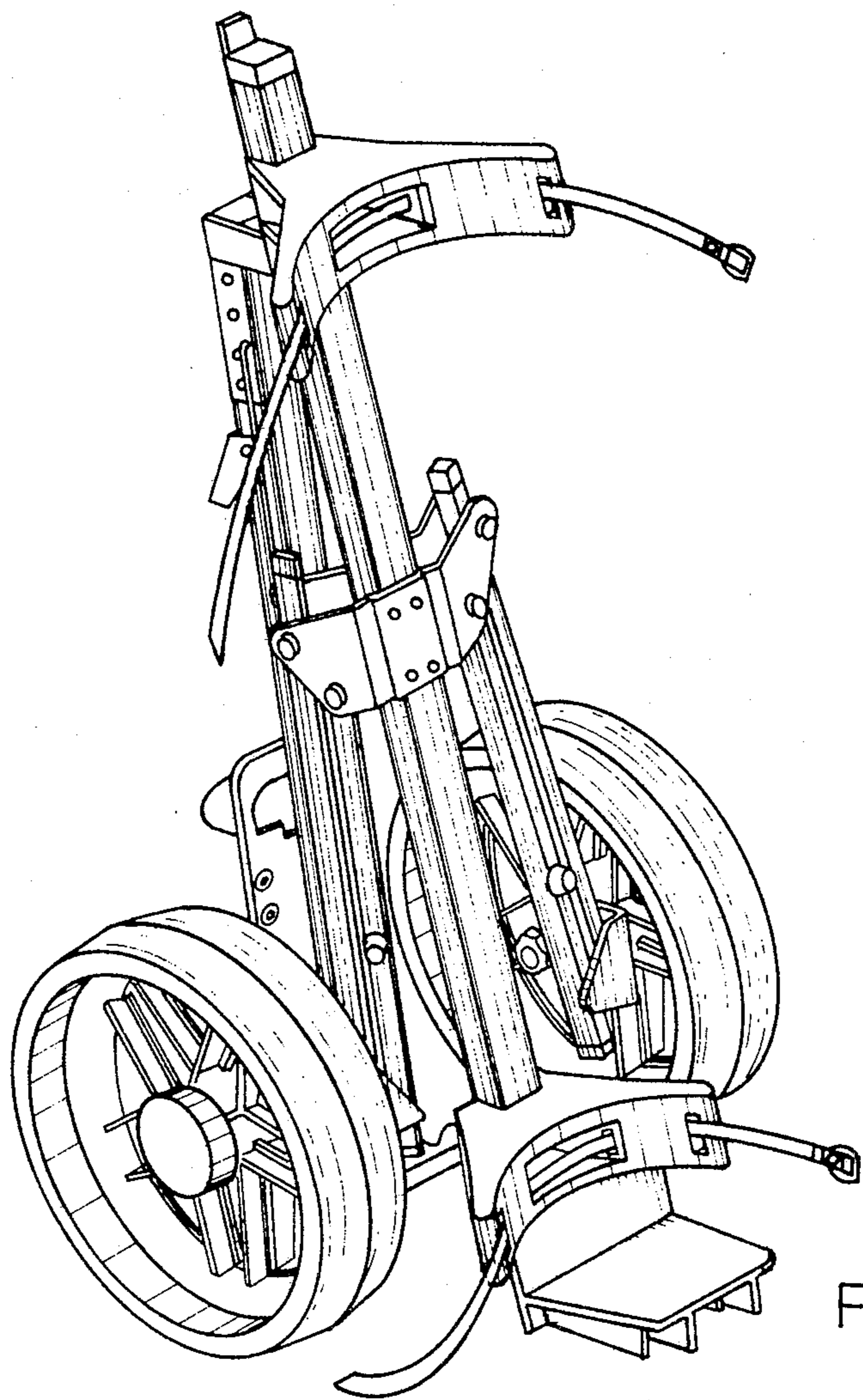

FIG. 1

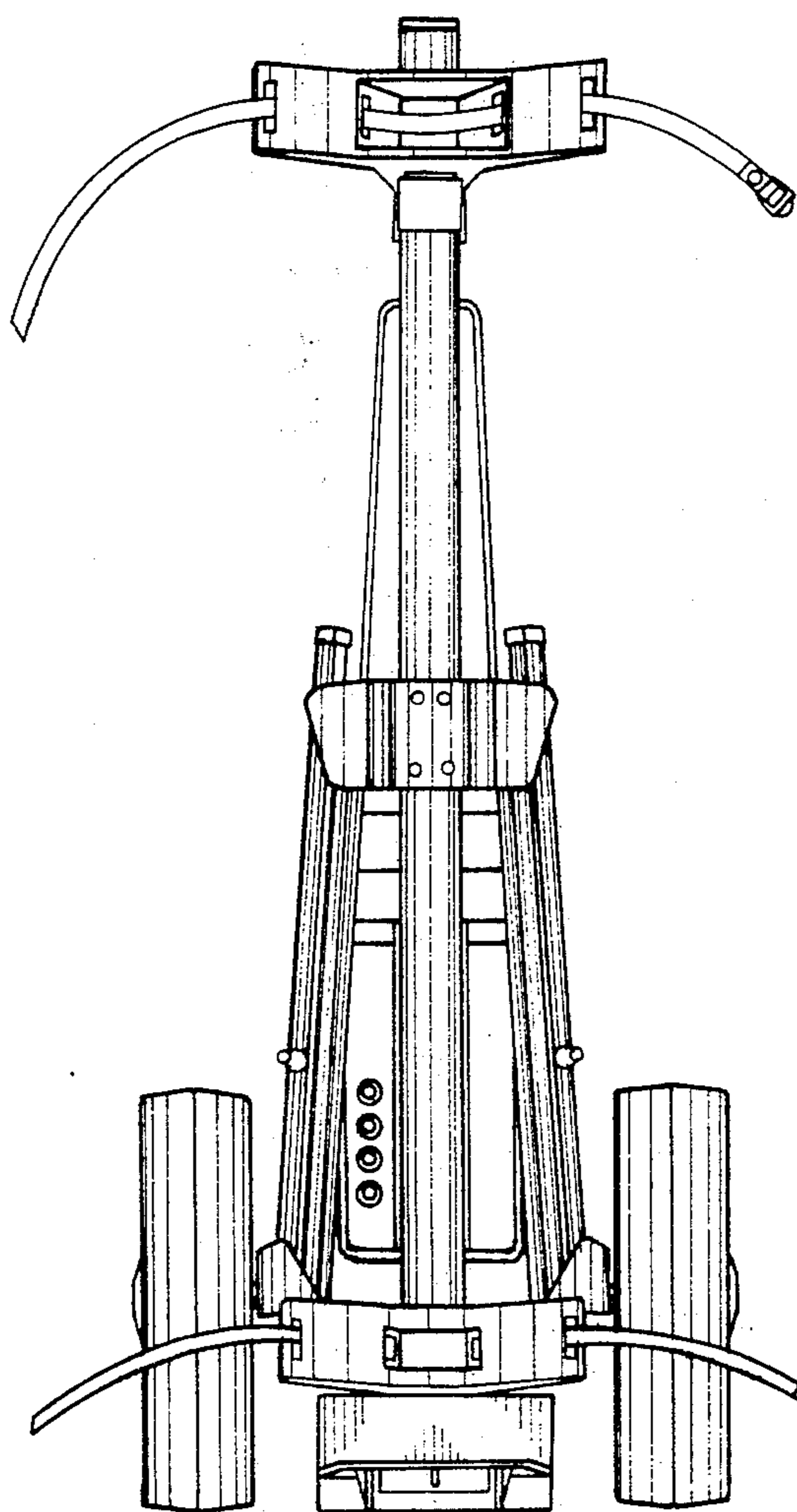

FIG. 2

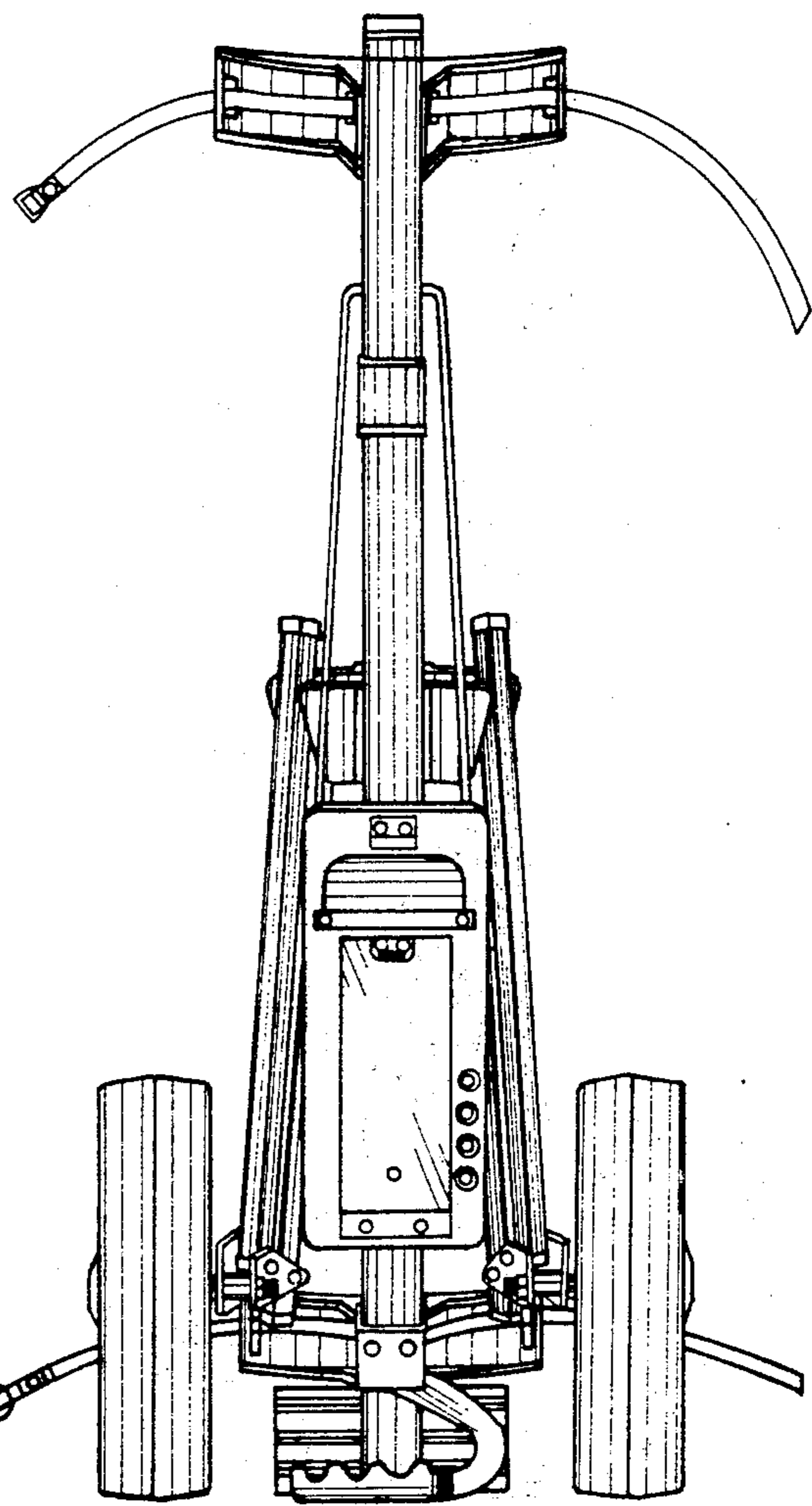

FIG. 3

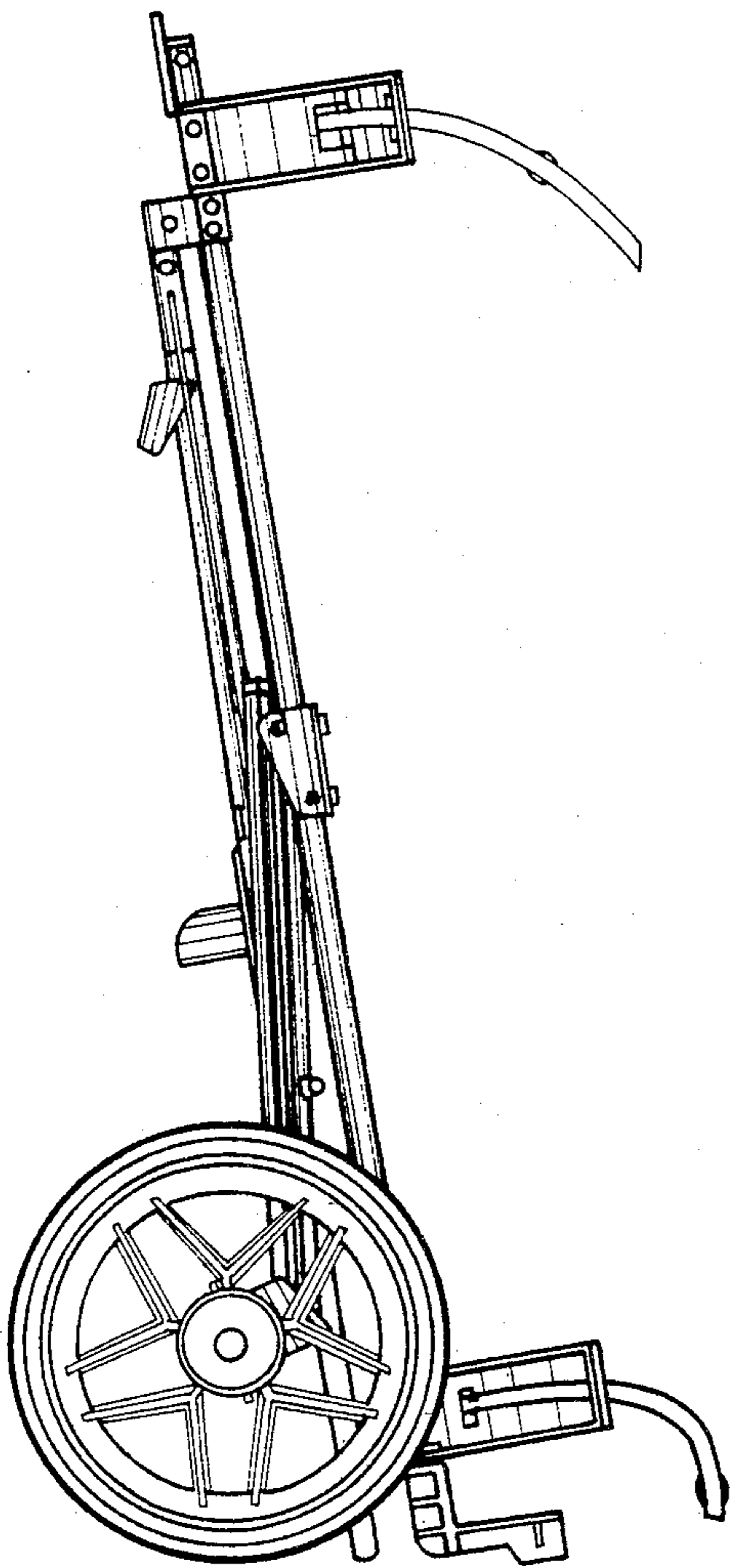

FIG. 5

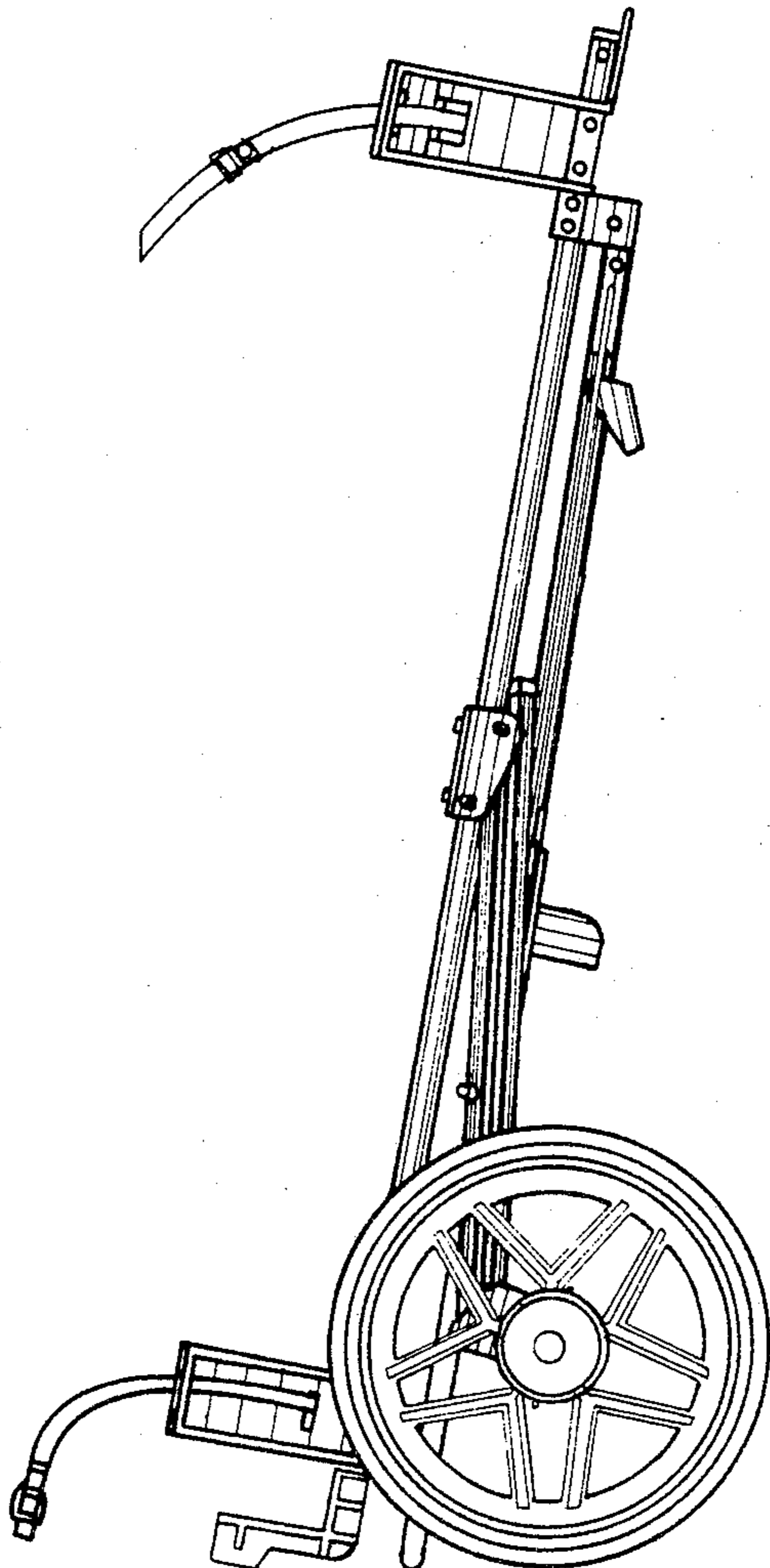

FIG. 4

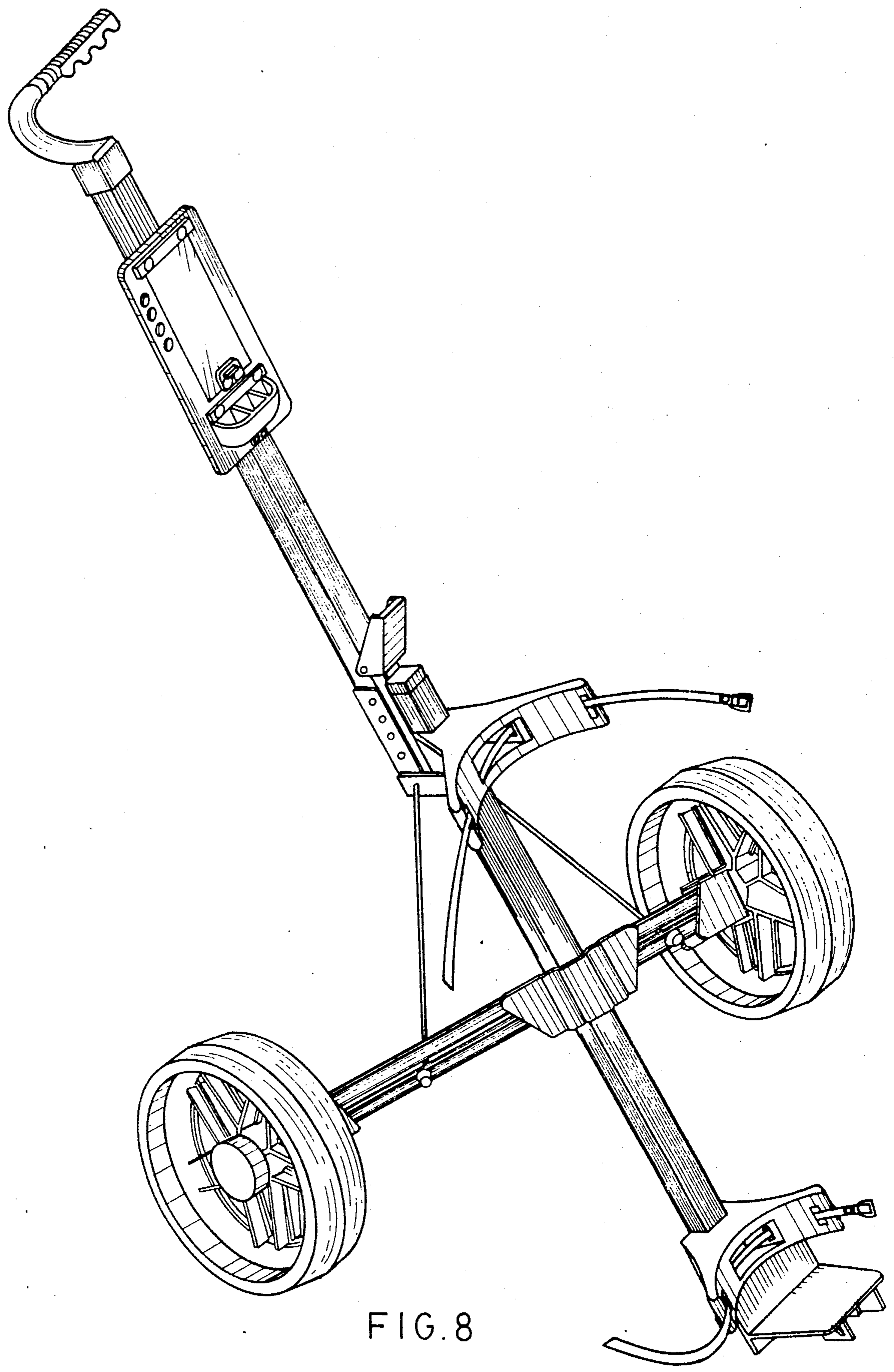

FIG. 8