

[54] **ALARM**

[76] **Inventor: Yau Ching-Hua, P.O. Box 2064,
Taichung, Taiwan**

[**] **Term: 14 Years**

[21] **Appl. No.: 690,742**

[22] **Filed: Jan. 11, 1985**

[52] **U.S. Cl. D10/106**

[58] **Field of Search D10/104, 106;
340/541-547, 551, 552, 555, 556, 566, 565, 577,
578, 579, 584, 586, 627, 629, 630**

[56] **References Cited**

U.S. PATENT DOCUMENTS

D. 260,741 9/1981 Lam D10/106
D. 264,194 5/1982 Jaretsky D10/106
D. 265,299 7/1982 Jaretsky D10/106

3,643,249 2/1972 Haywood 340/542
3,732,843 5/1973 Pappas et al. D10/106 X
3,878,539 4/1975 Gooding 340/546

Primary Examiner—Catherine E. Kemper
Attorney, Agent, or Firm—Ladas & Parry

[57] **CLAIM**

The ornamental design for an alarm, as shown.

DESCRIPTION

FIG. 1 is a perspective view of an alarm showing my new design;
FIG. 2 is a top plan view thereof;
FIG. 3 is a side elevational view, the opposite side being a mirror image thereof;
FIG. 4 is an end elevational view thereof;
FIG. 5 is an elevational view of the opposite end thereof;
FIG. 6 is a bottom plan view thereof.

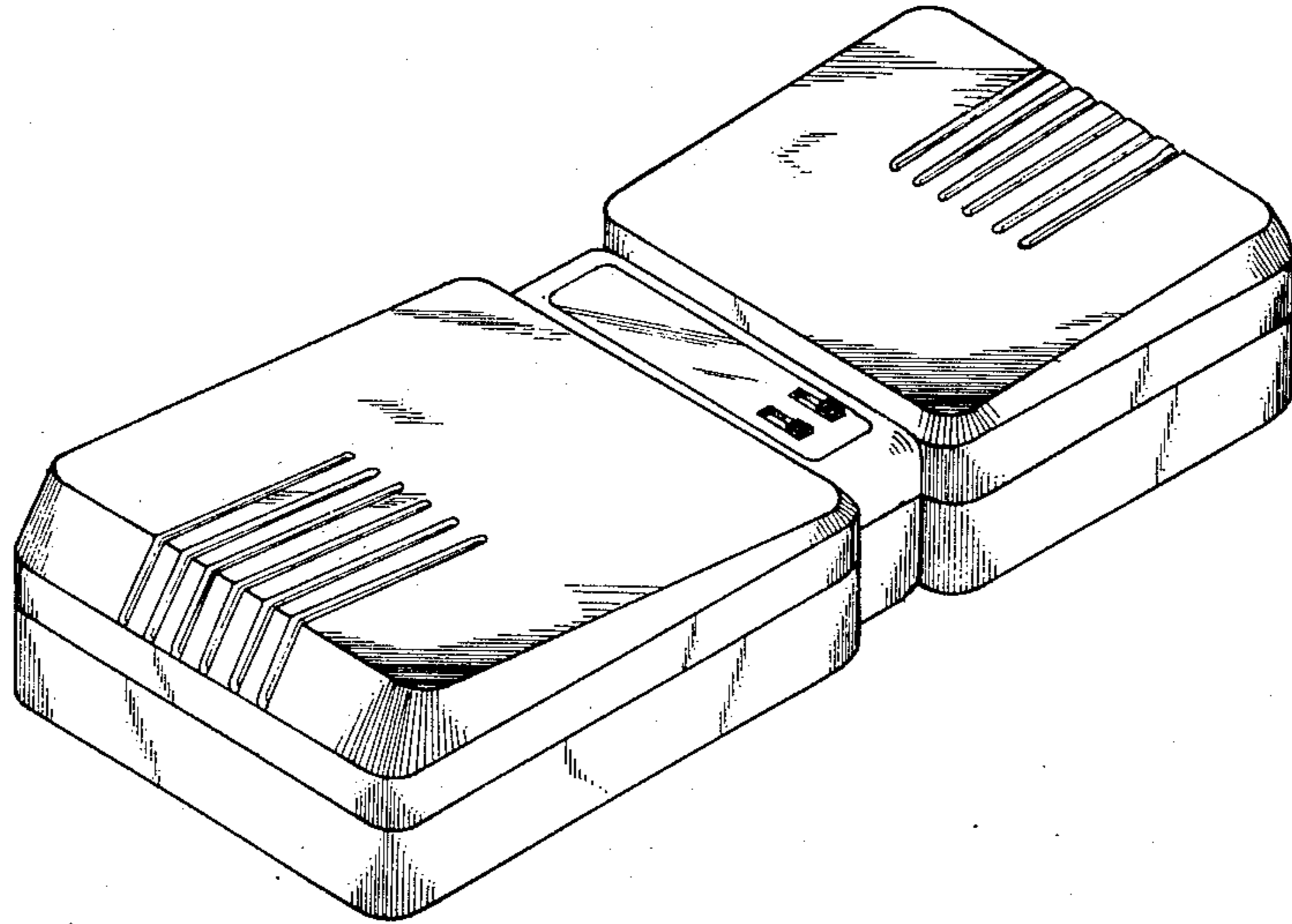

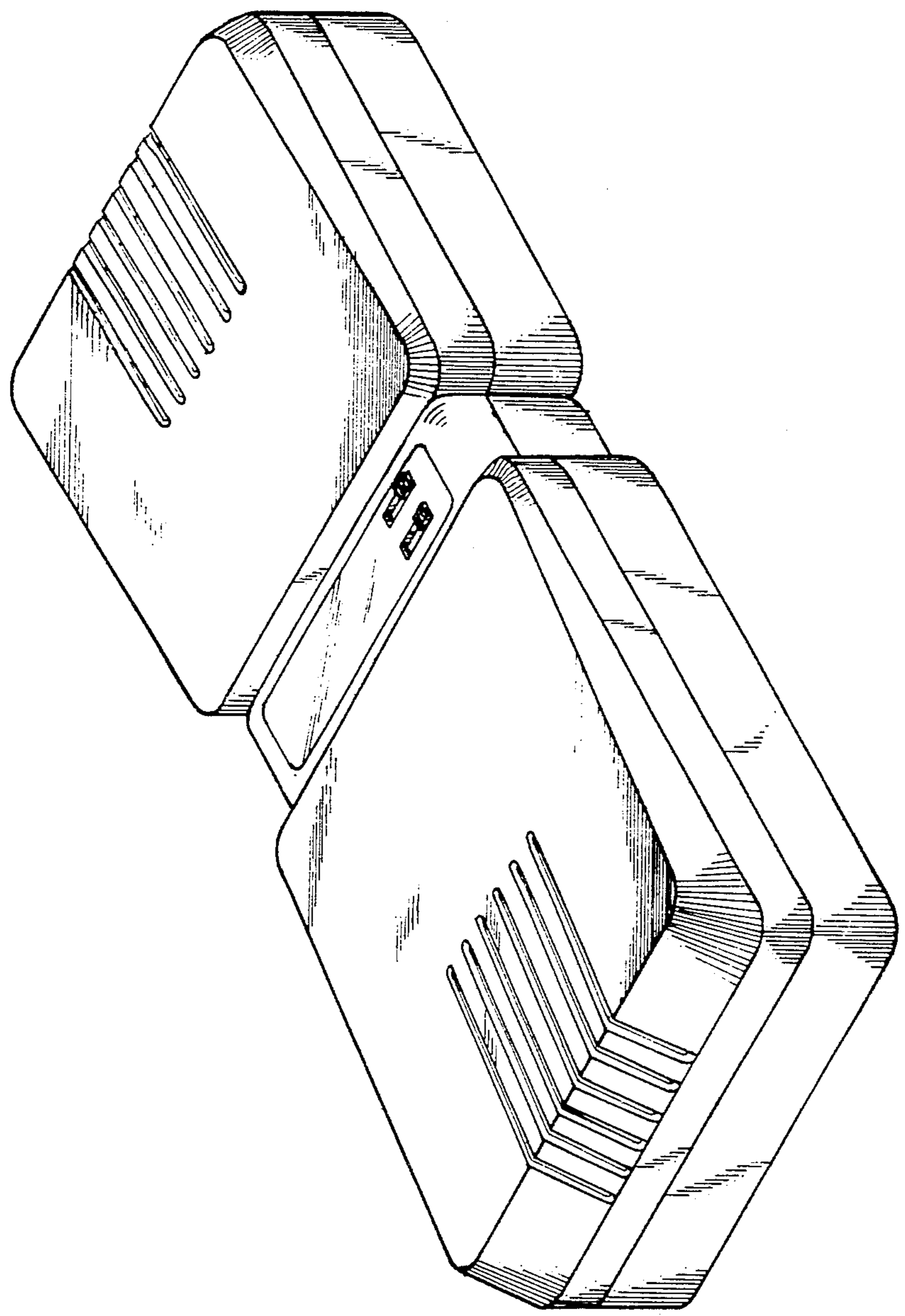

FIG. 1

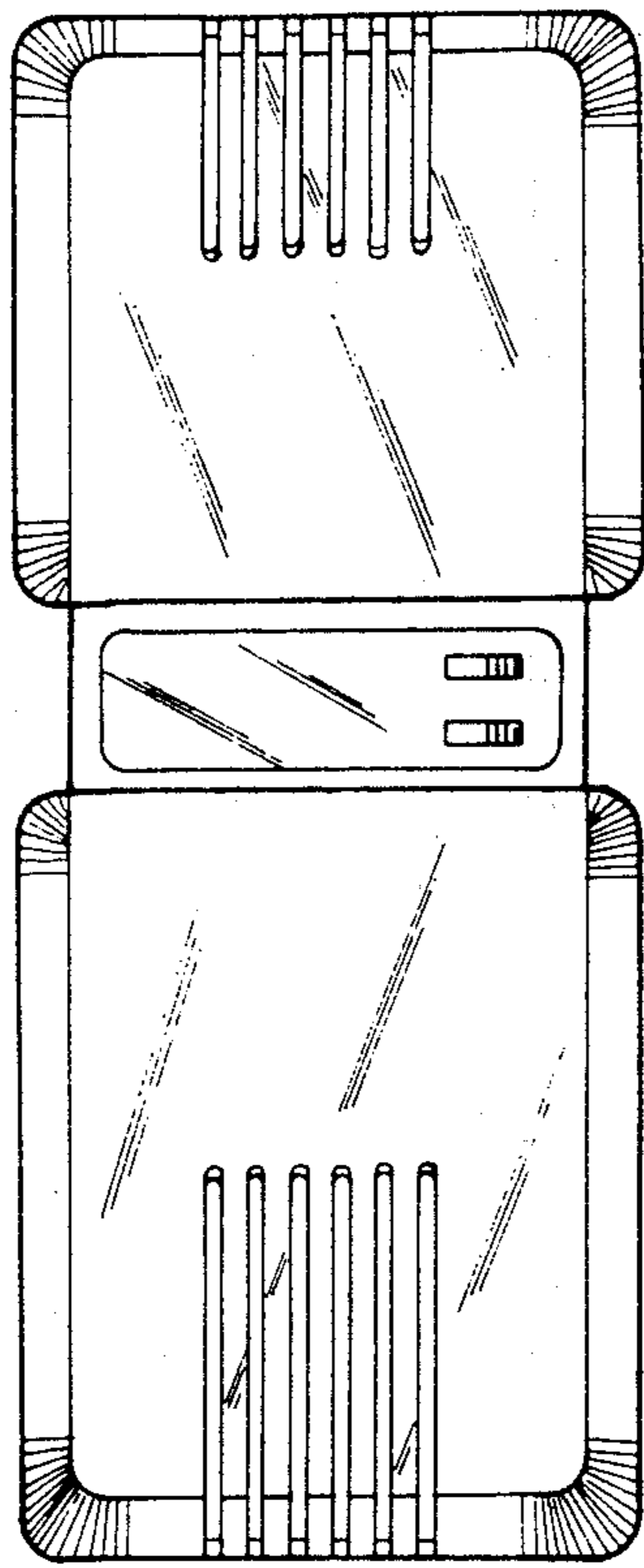

FIG. 2

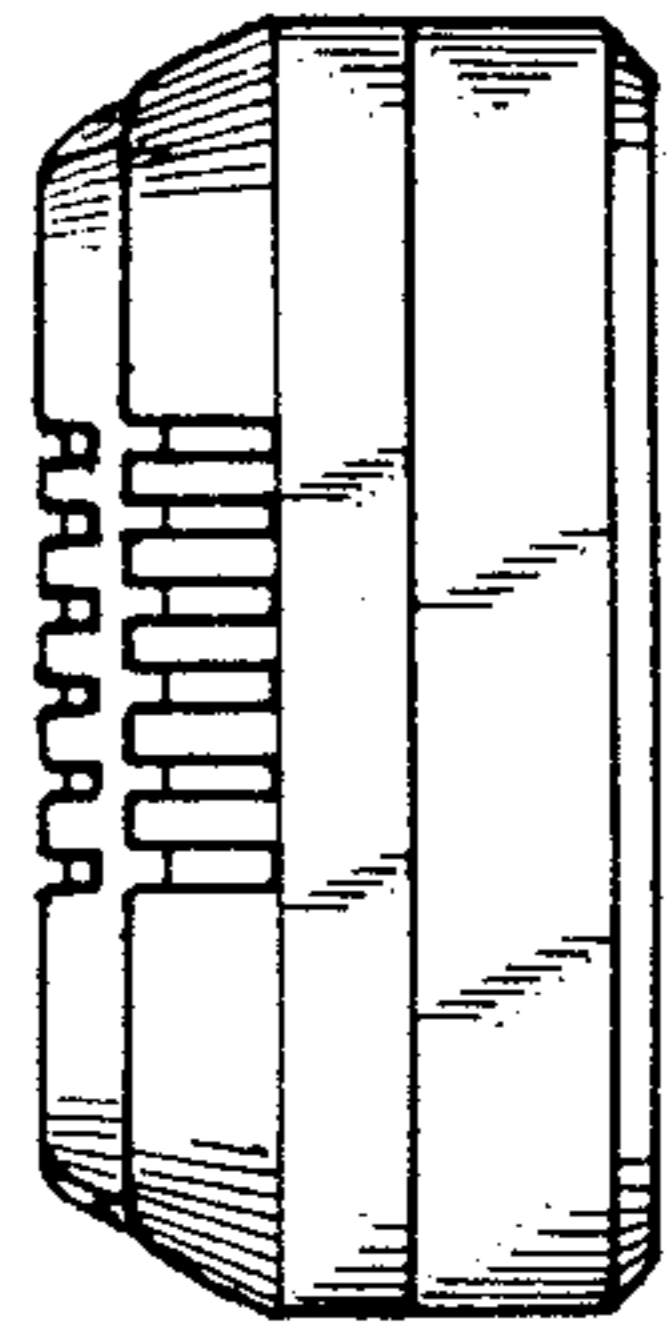

FIG. 4

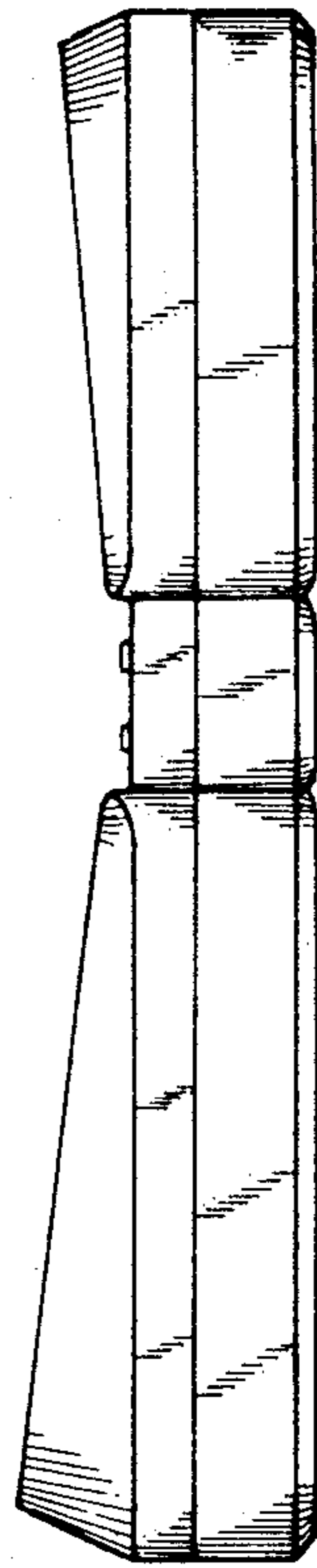

FIG. 3

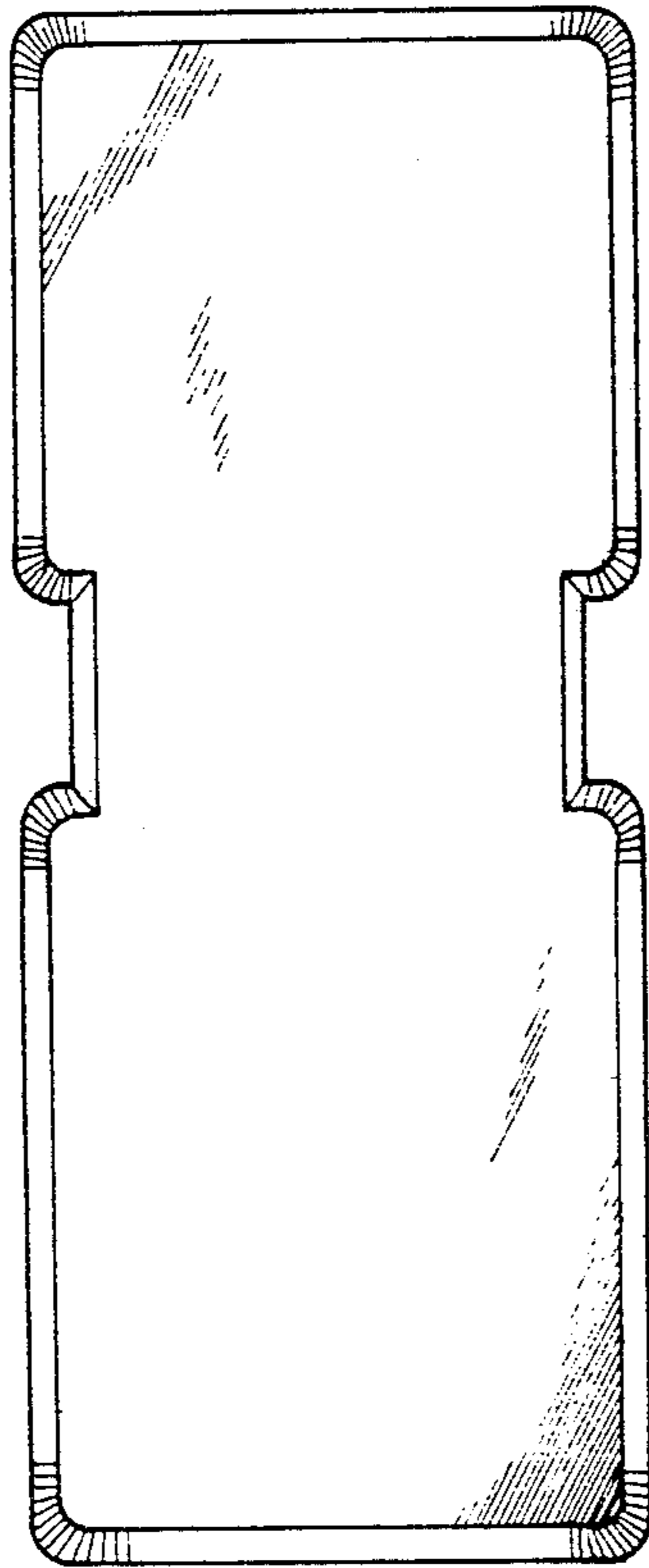

FIG. 6

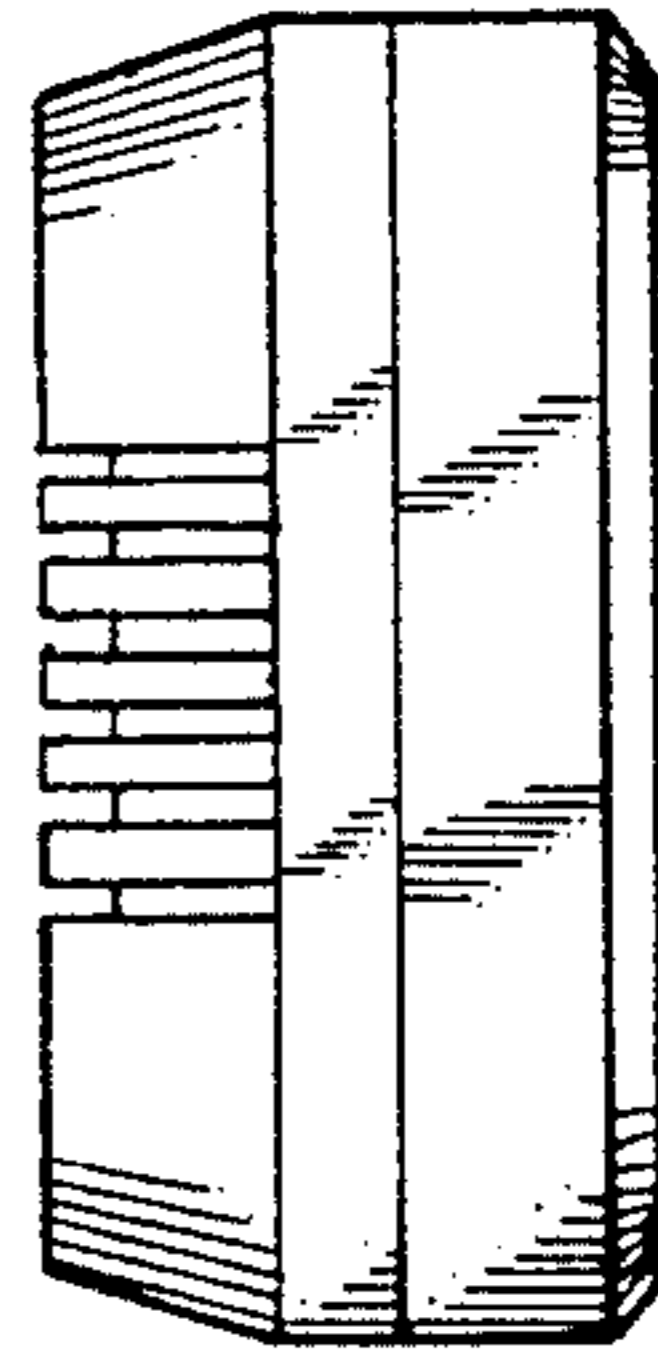

FIG. 5