

[54] RACK FOR HOLDING CARDS USED IN TEACHING MATHEMATICS

1,955,340 4/1934 McPherson 273/150
2,763,485 9/1956 Dial 273/150

[75] Inventor: Vernon J. Mortensen, Coeur d'Alene, Id.

Primary Examiner—Melvin B. Feifer
Attorney, Agent, or Firm—Wells, St. John & Roberts

[73] Assignee: Mortensen Educational Products, Inc., Chatsworth, Calif.

[57] CLAIM

The ornamental design for a rack for holding cards used in teaching mathematics, as shown and described.

[**] Term: 14 Years

DESCRIPTION

[21] Appl. No.: 718,639

FIG. 1 is a perspective view of a rack for holding cards used in teaching mathematics showing my new design; FIG. 2 is a front elevational view thereof; FIG. 3 is a top plan view thereof; FIG. 4 is a left side elevational view thereof; FIG. 5 is a right side elevational view thereof; FIG. 6 is a cross sectional view taken along line 6—6 of FIG. 3 thereof; FIG. 7 is a bottom plan view thereof; FIG. 8 is another top view taken along line 8—8 of FIG. 4 thereof; and FIG. 9 is a rear elevational view.

[22] Filed: Apr. 1, 1985

[52] U.S. Cl. D21/54; D19/90; D6/468; D6/474

[58] Field of Search D21/54, 55; D19/90, D19/91; D6/474, 468; 273/150, 148

[56] References Cited

U.S. PATENT DOCUMENTS

D. 55,077 5/1920 Page D19/90
D. 282,989 3/1986 Nelson D6/474

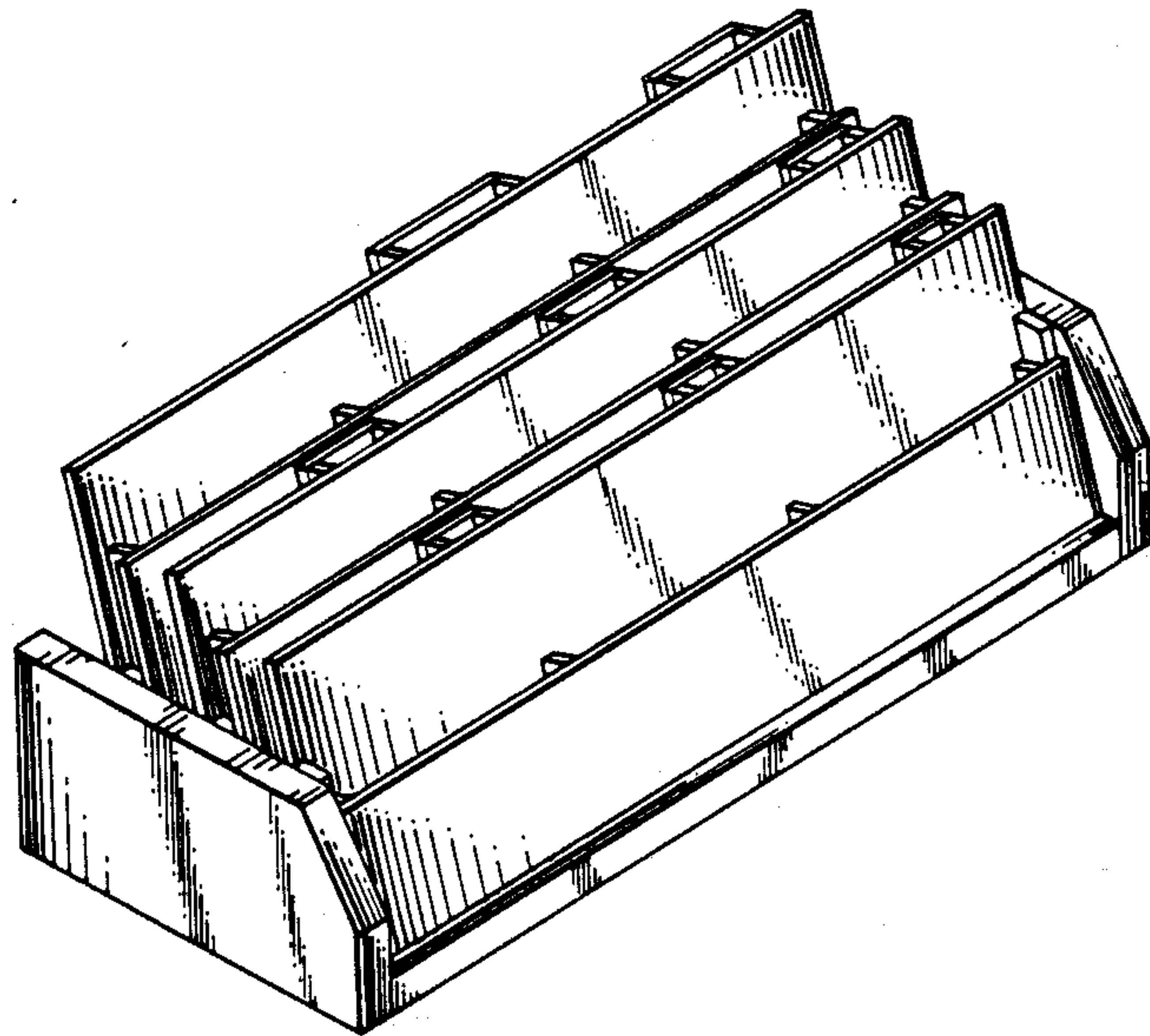

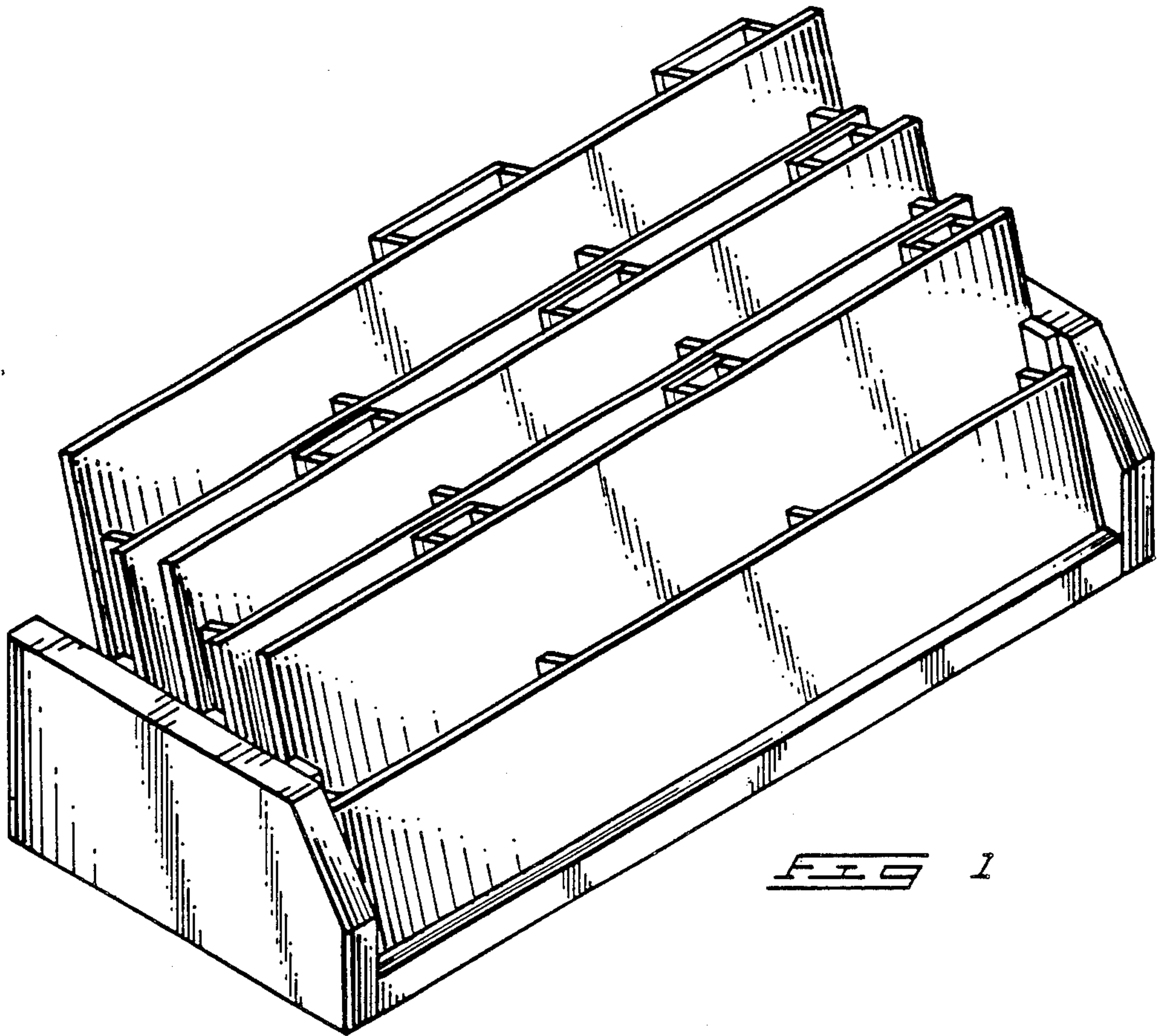

FIG 1

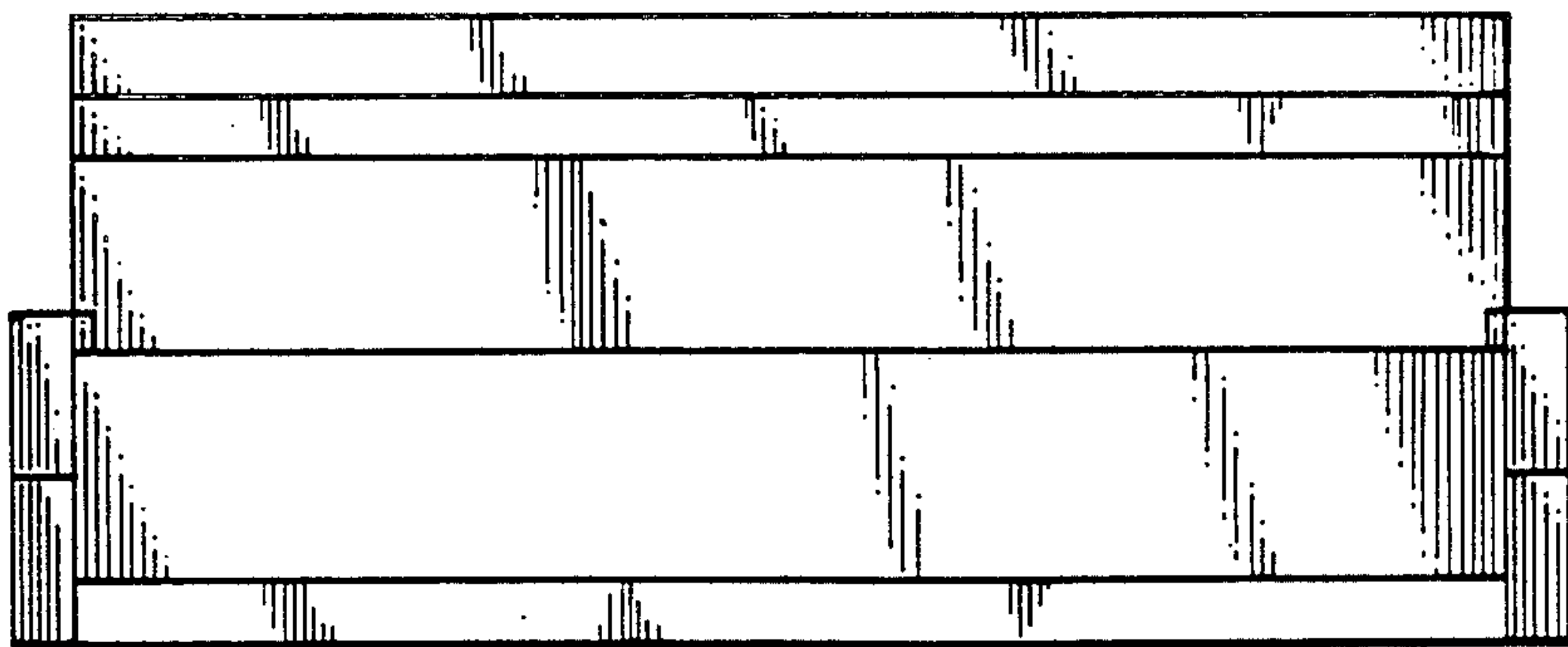

FIG 2

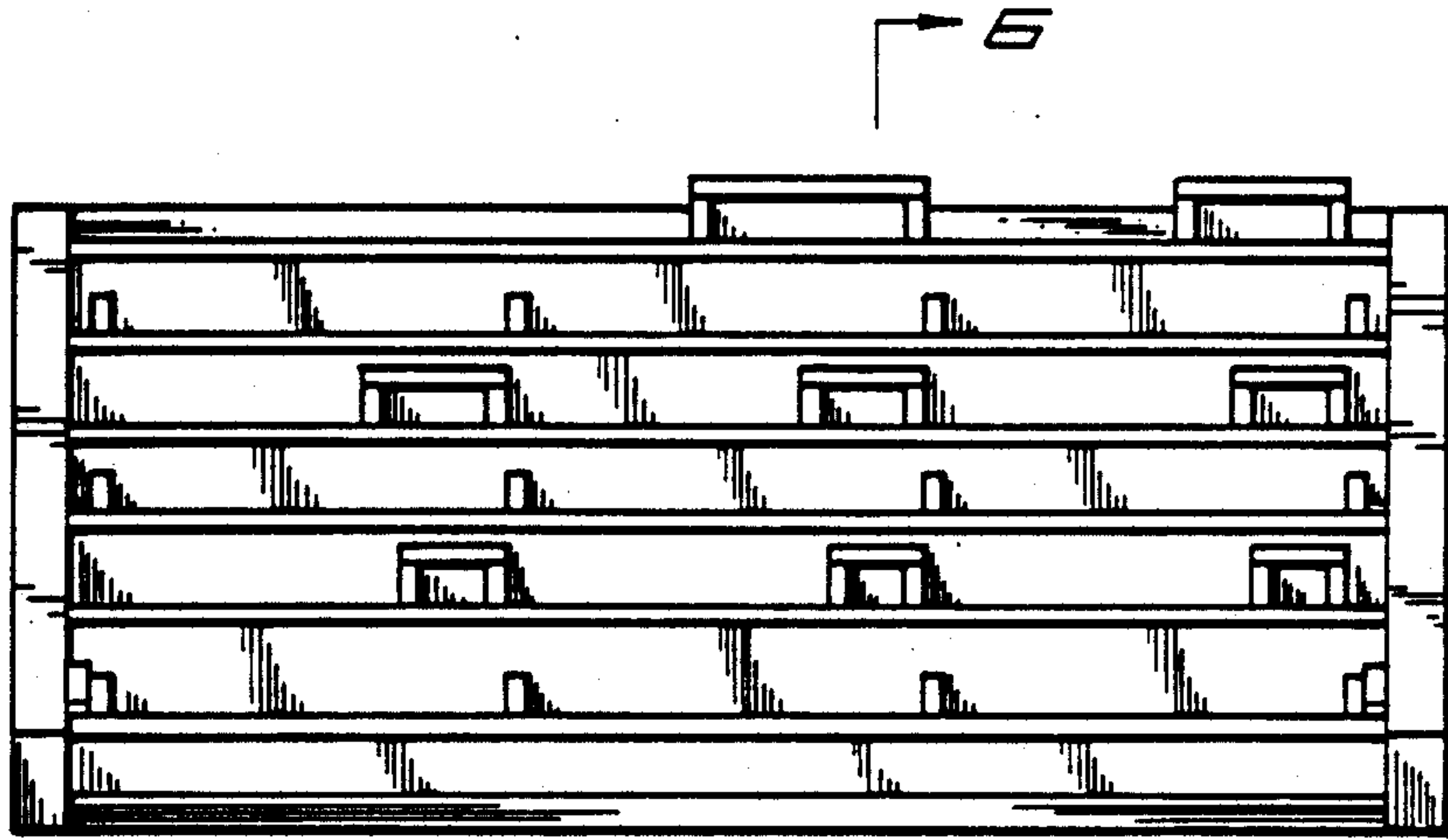

FIG 3

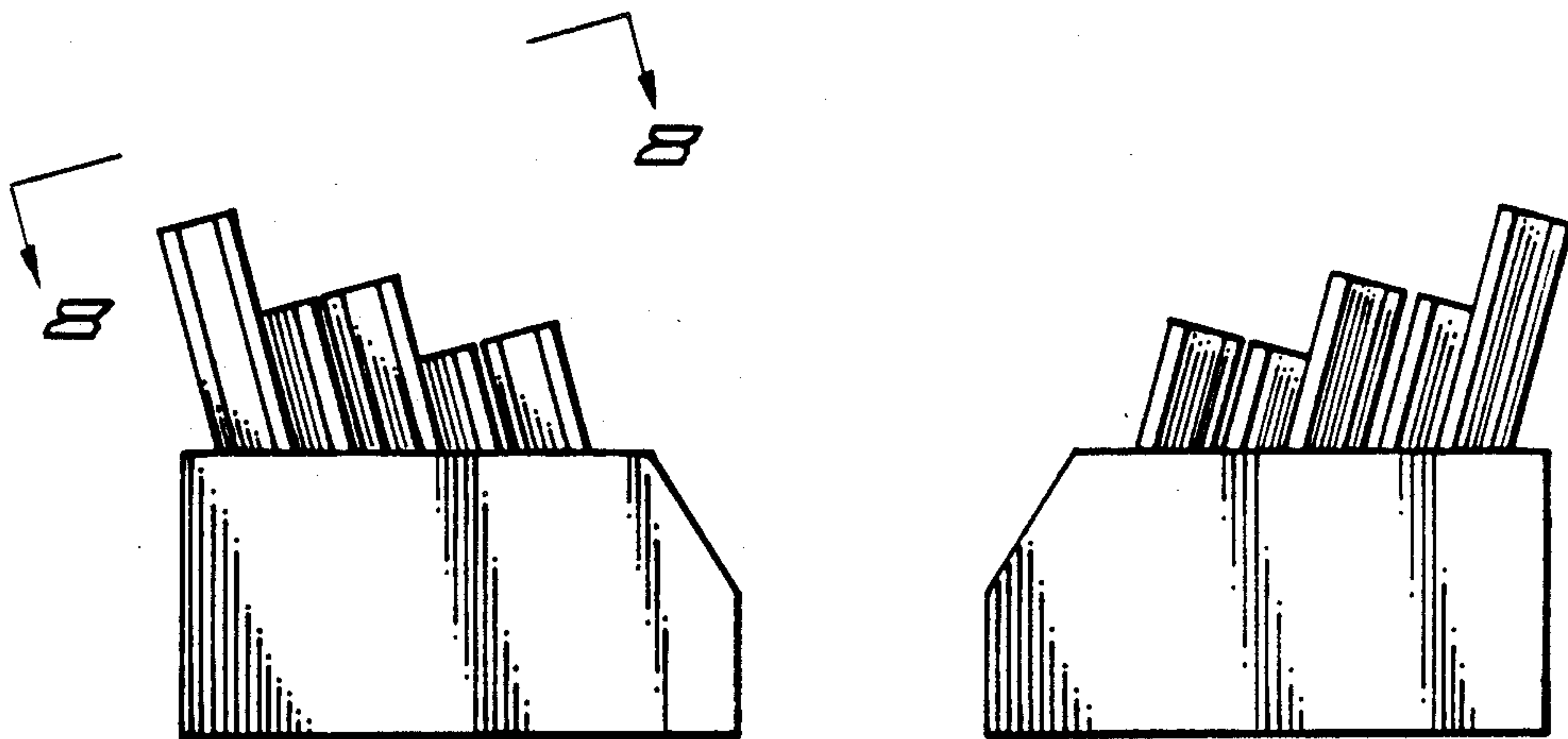

FIG 4

FIG 5

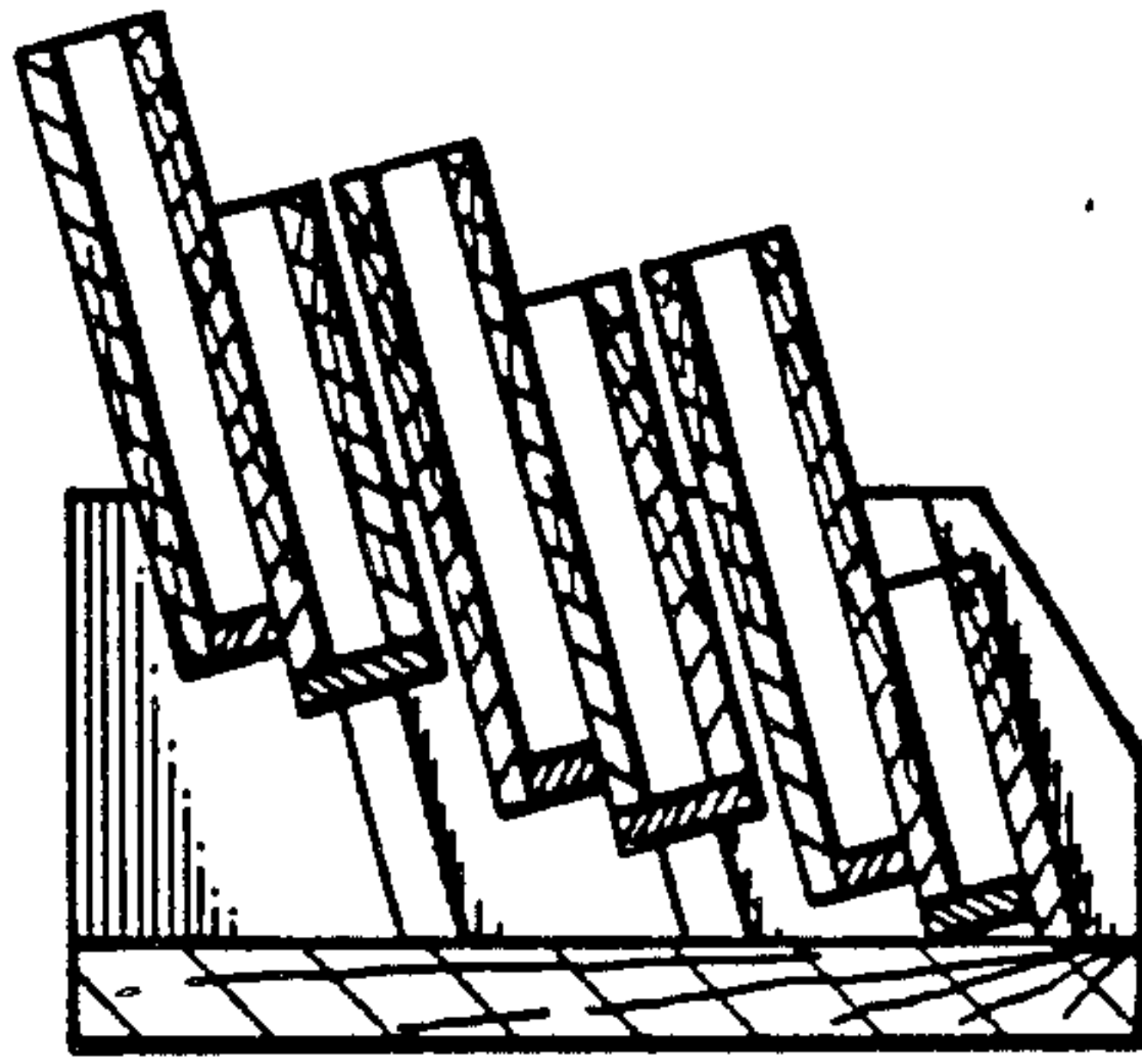

FIG 6

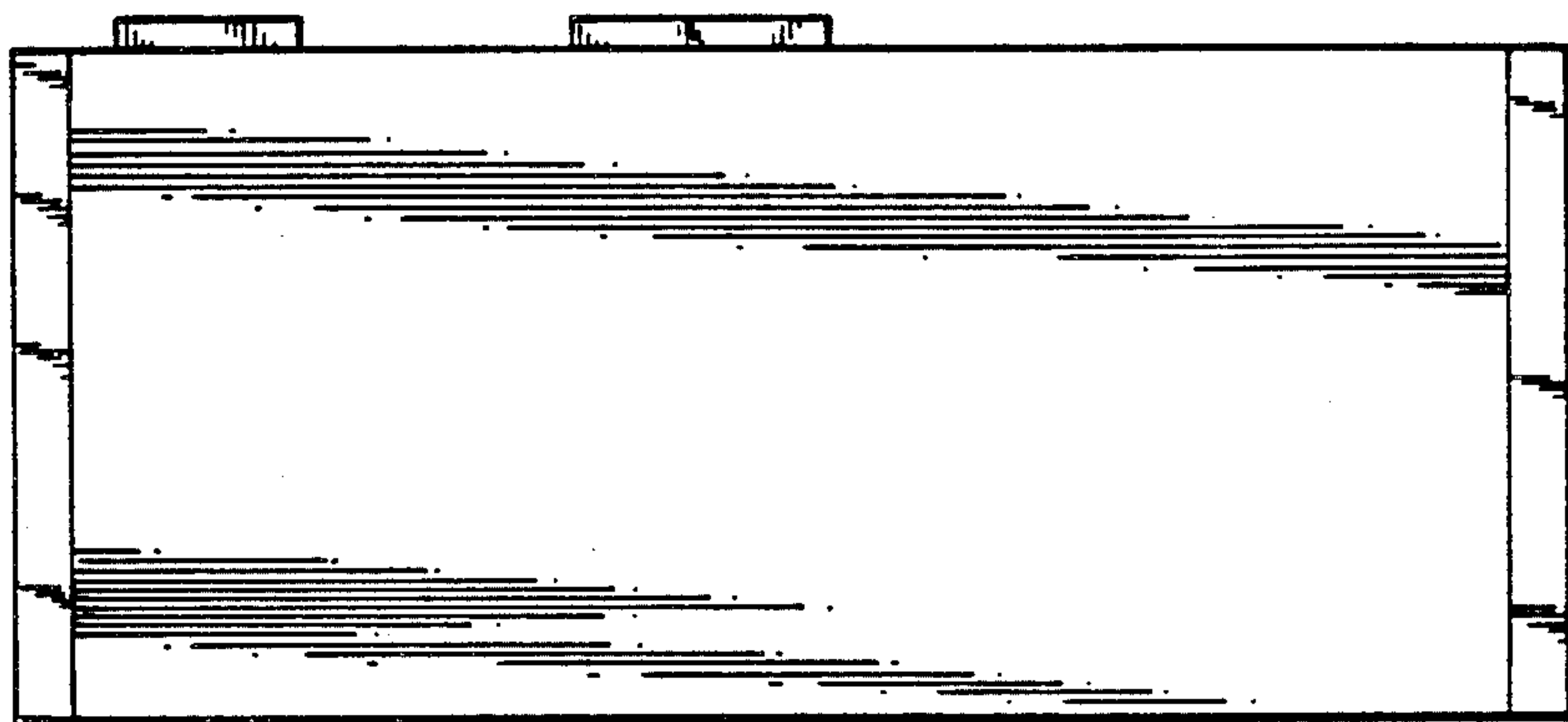

FIG 7

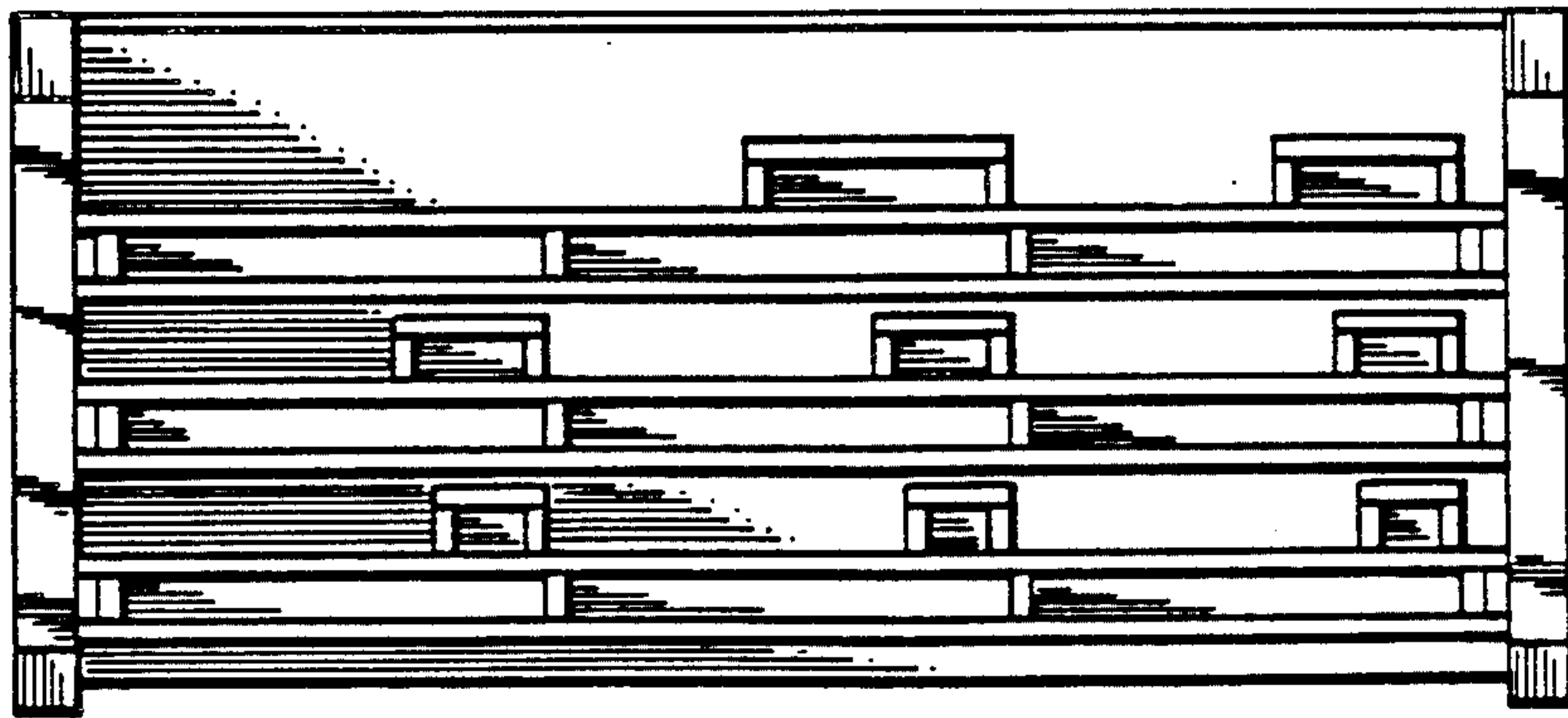

FIG 8

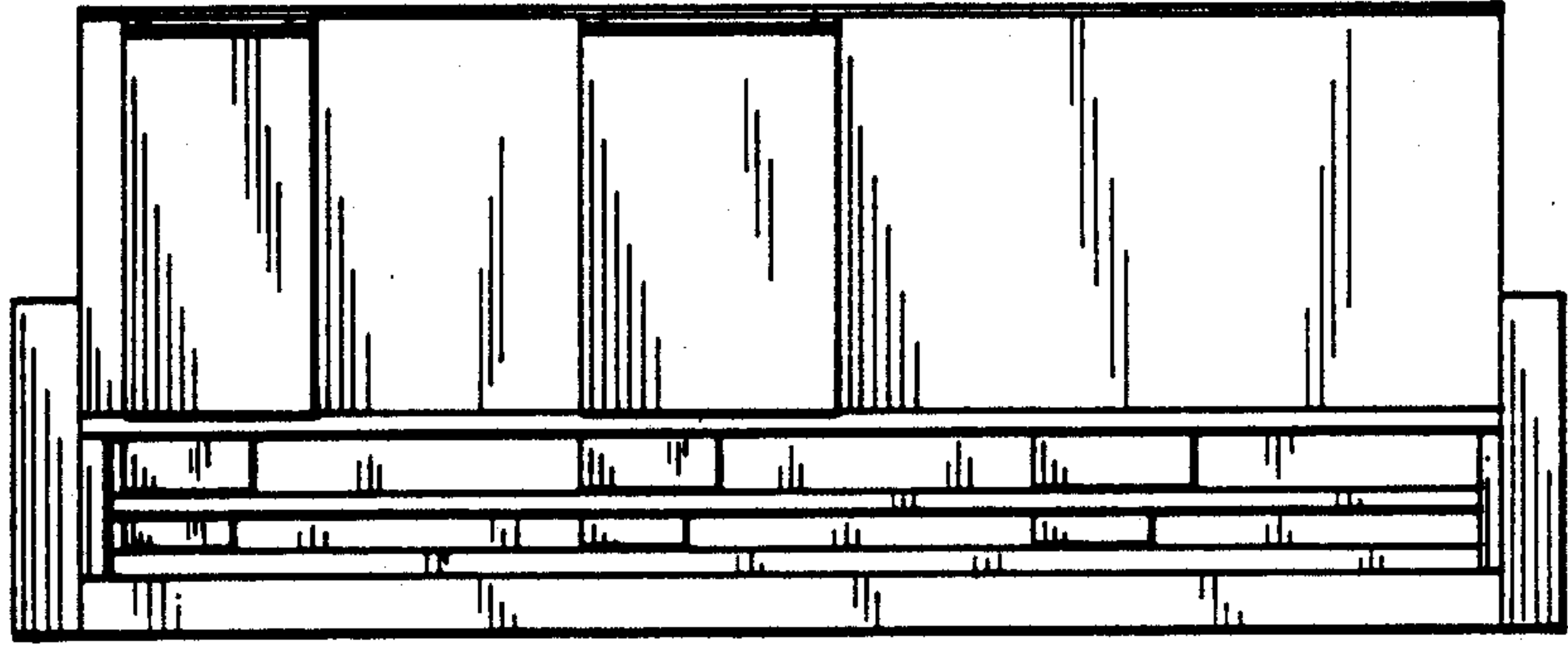

FIG 9