

[54] DISPLAY CASE FOR MINIATURE SPORTS HEADGEAR

3,948,396 10/1974 Upton .  
4,421,230 6/1982 Stanton .

[76] Inventors: Leonard L. Perkins; Anthony Perkins, both of 4944 Twelfth St., NE., Washington, D.C. 20017

Primary Examiner—Carmen H. Vales  
Attorney, Agent, or Firm—Shlesinger Arkwright Garvey

[\*\*] Term: 14 Years

[57] CLAIM

[21] Appl. No.: 693,243

The ornamental design for a display case for miniature sport.

[22] Filed: Jan. 22, 1985

DESCRIPTION

[52] U.S. Cl. .... D6/471

[58] Field of Search ..... D6/471, 470, 467, 468; 211/13; 312/114

FIG. 1 is a front perspective view of a display case for miniature sports headgear showing our new design; FIG. 2 is a right side elevational view thereof; FIG. 3 is a left side elevational view thereof; FIG. 4 is a rear elevational view thereof; FIG. 5 is a front perspective view of a modified form of the display case for miniature sports headgear described in FIG. 1 showing my new design; FIG. 6 is a right side elevational view thereof; FIG. 7 is a left side elevational view thereof; FIG. 8 is a rear elevational view thereof;

[56] References Cited

U.S. PATENT DOCUMENTS

D. 46,999	2/1915	Kingman	.....	D6/471
D. 47,664	8/1915	Garland	.....	D6/471
D. 154,025	6/1949	Crull	.....	D6/471 X
D. 157,247	2/1950	Evans	.....	D6/471
D. 161,956	2/1951	Newburger	.....	D6/471
D. 244,656	6/1977	Lawson	.....	D6/471
1,076,501	10/1913	Kress	.	
1,106,543	8/1914	Burnham	.	
1,622,107	3/1927	Harrod	.	
2,681,262	6/1954	Vincent	.	
3,667,826	6/1972	Wood	.	

The bottoms of the design shown in FIGS. 1 through 4 and FIGS. 5 through 8 rest on a flat surface and are planar.

The bottom plan view of both embodiments is flat and unornamented.

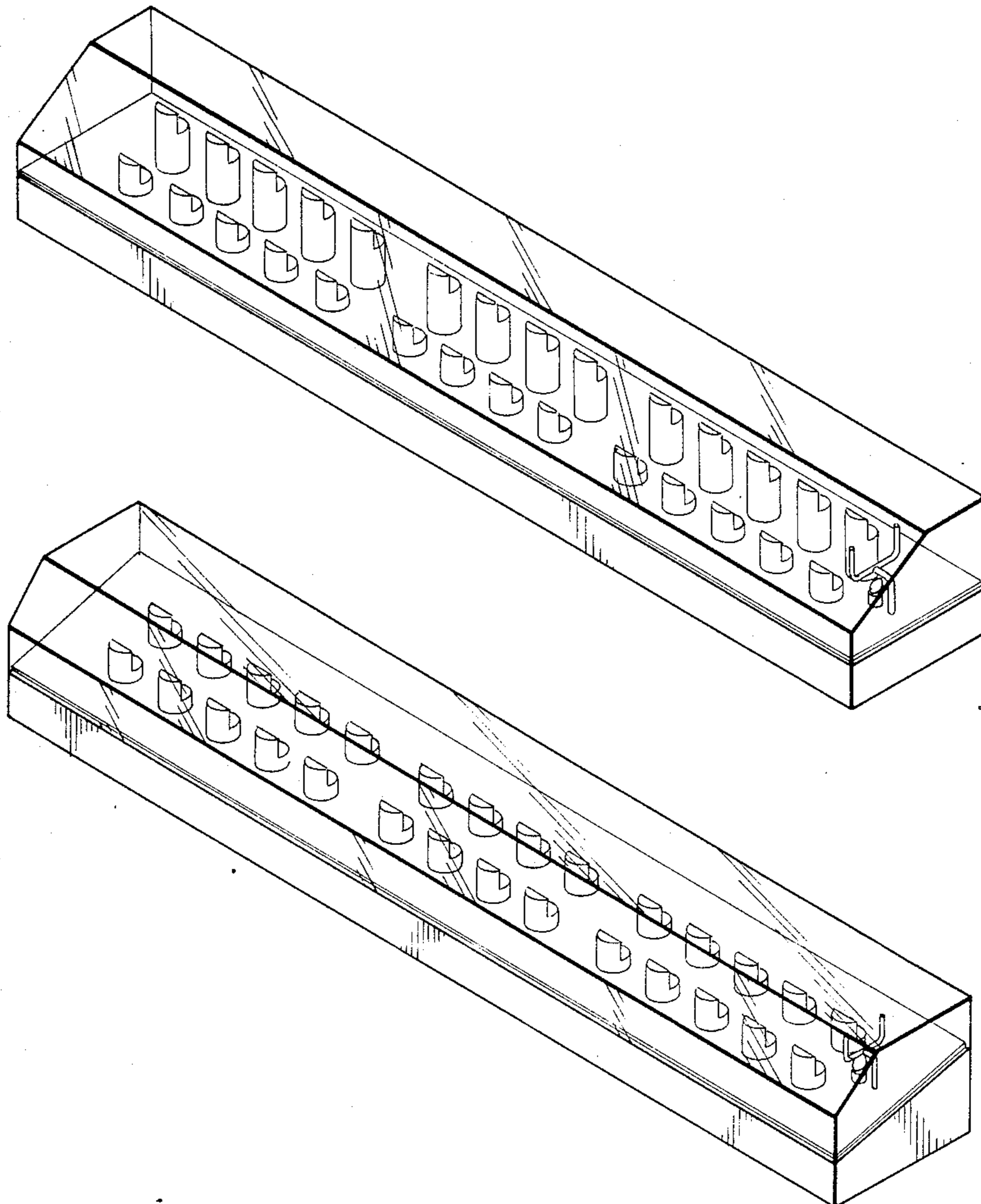

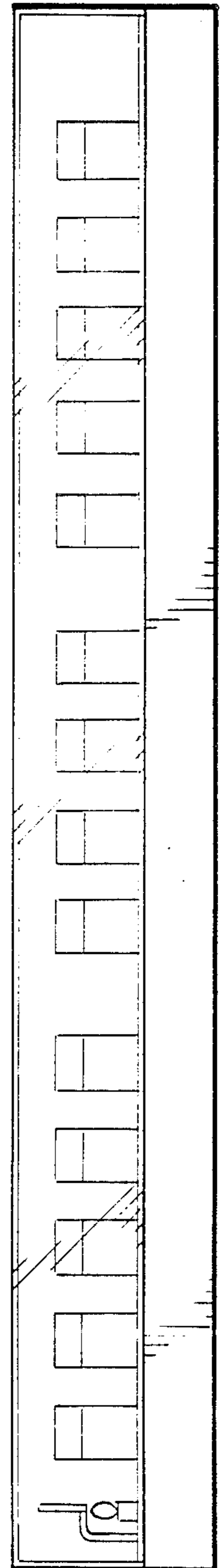
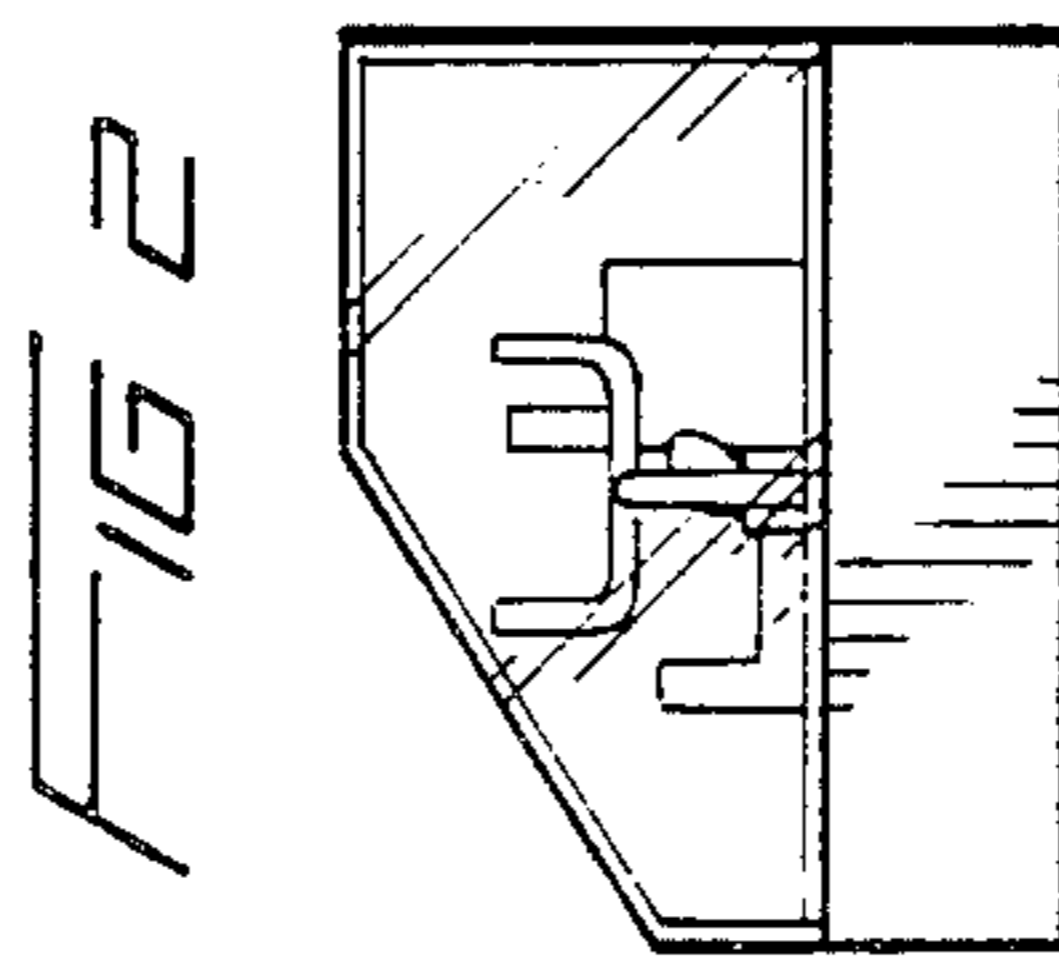
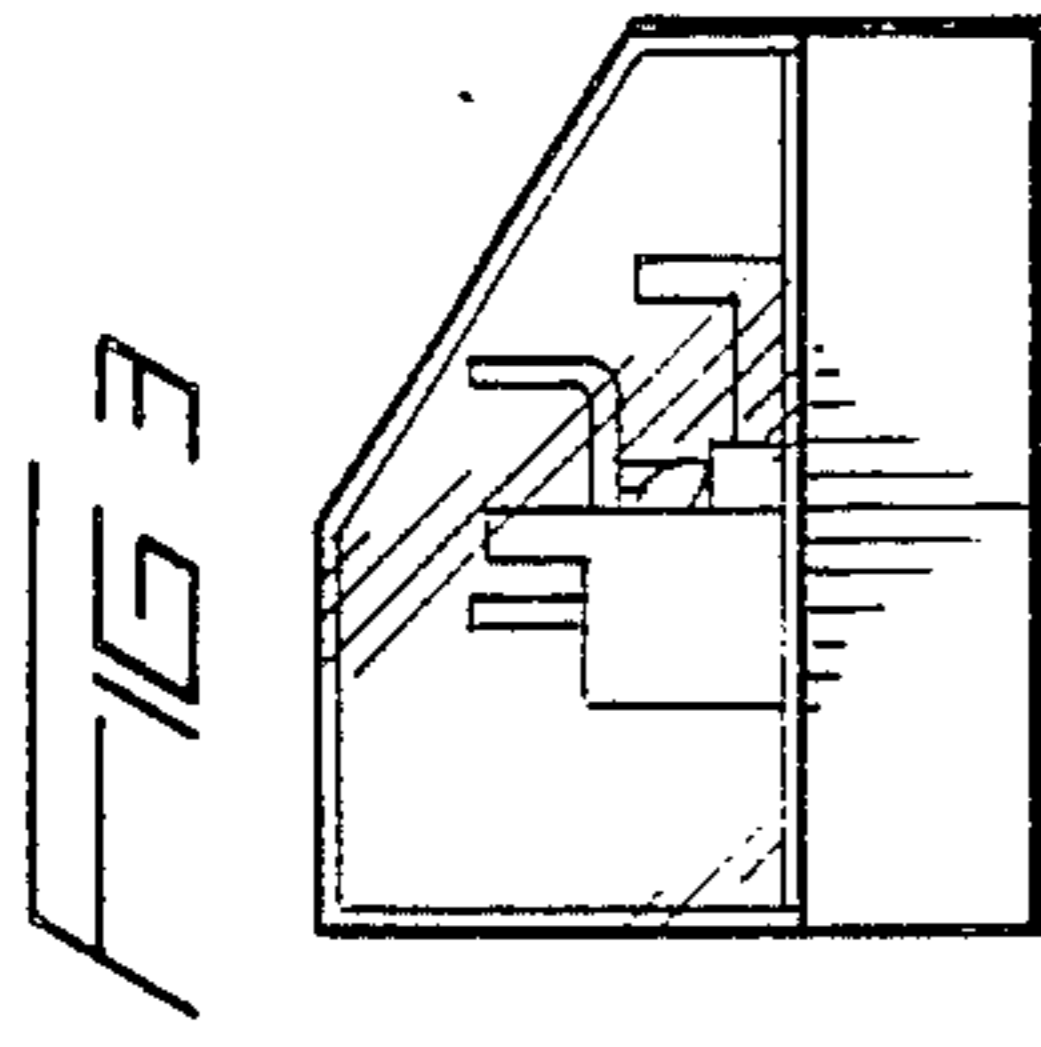
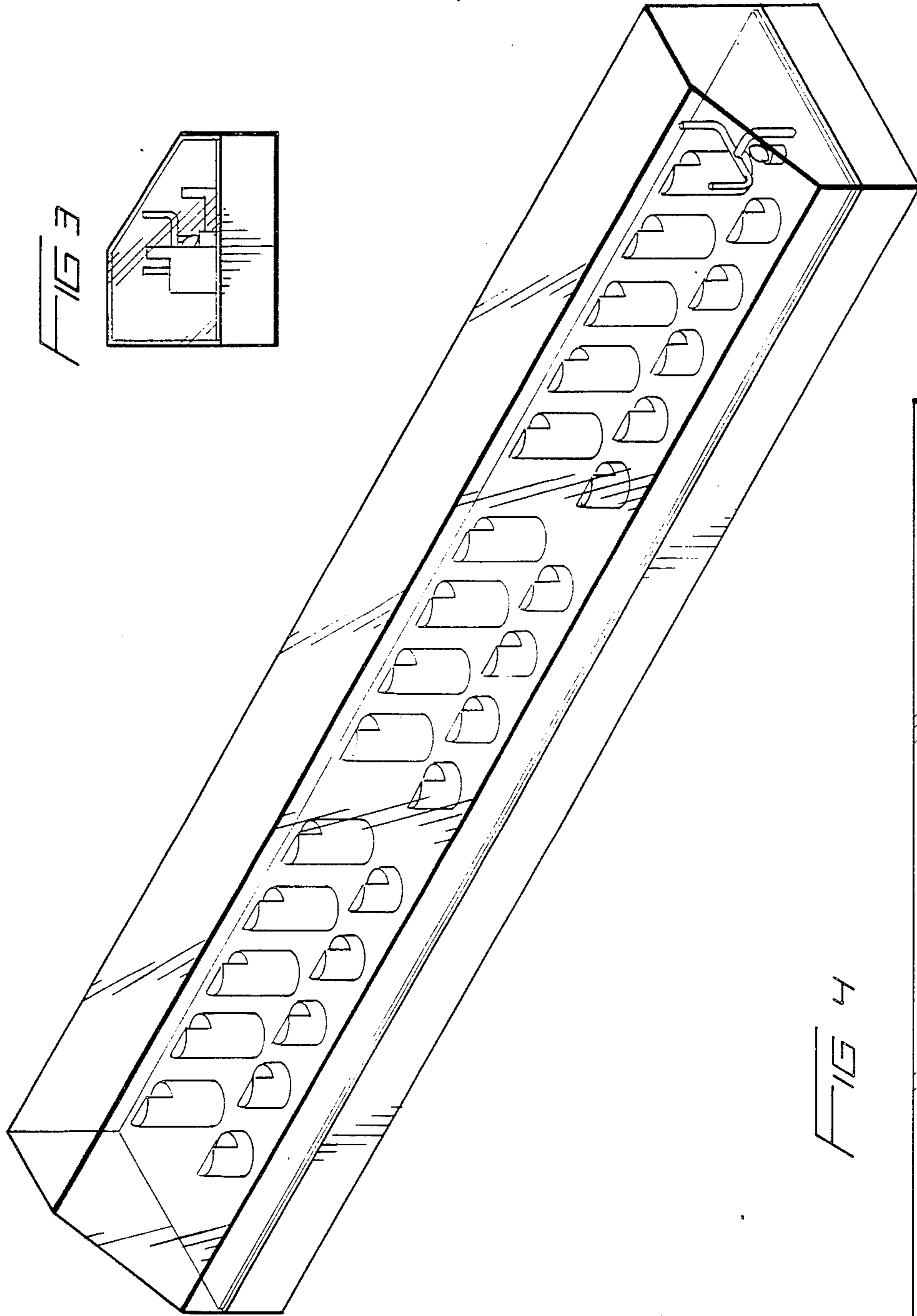

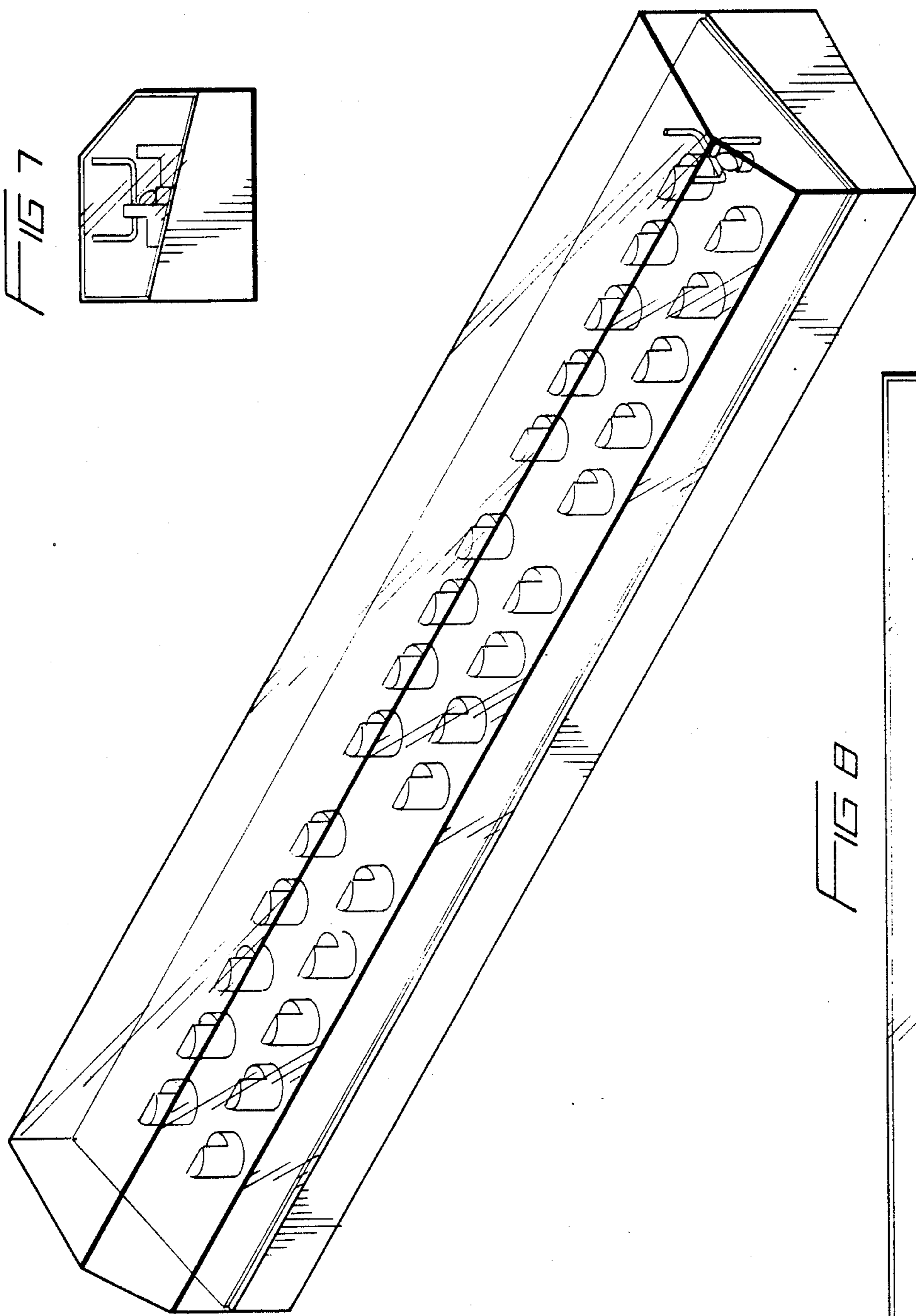

FIG 5

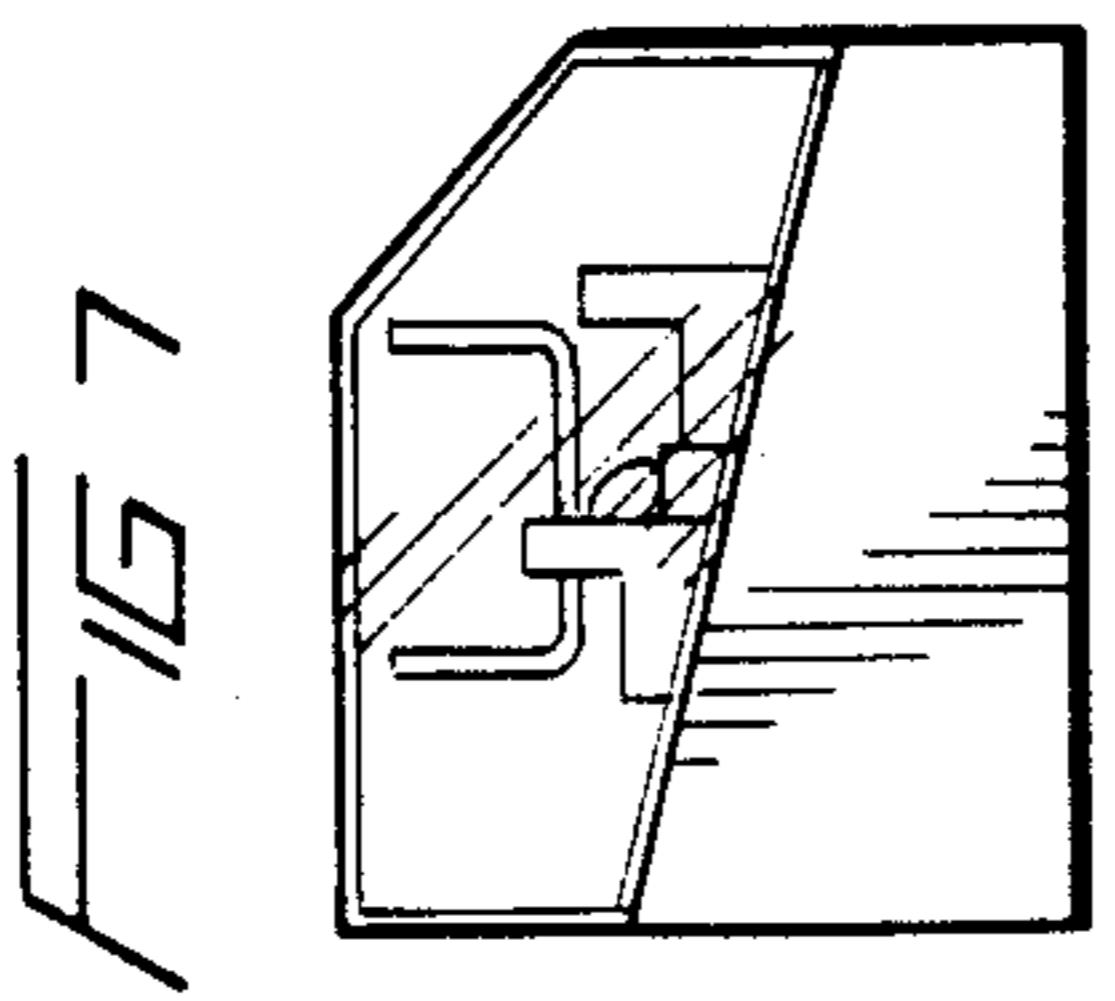

FIG 7

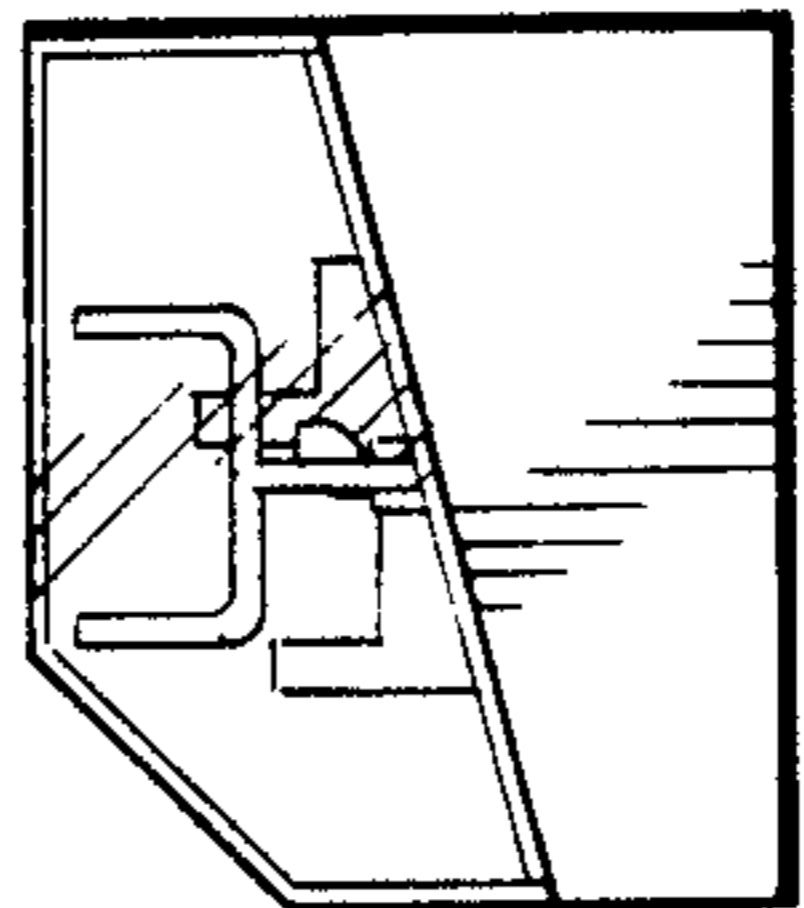

FIG 6

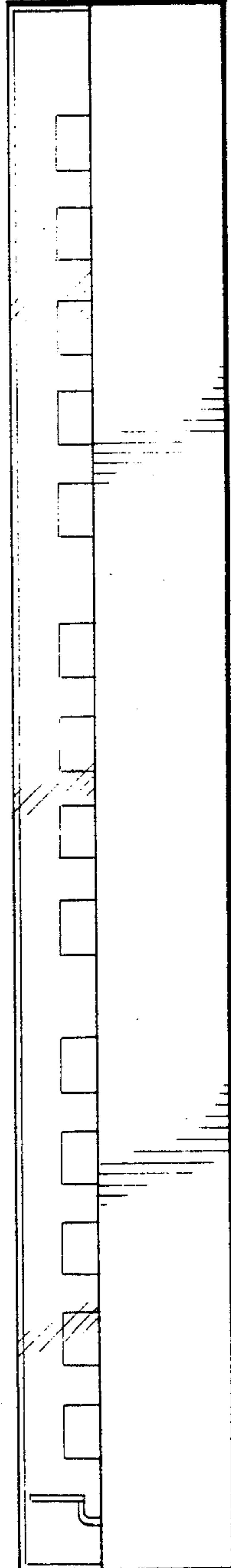

FIG 8