

- [54] **COMBINED KITCHEN APPLIANCE AND BASE ASSEMBLY**
- [75] **Inventor: Robert Osit, Shelton, Conn.**
- [73] **Assignee: Black & Decker, Inc., Newark, Del.**
- [**] **Term: 14 Years**
- [21] **Appl. No.: 870,735**
- [22] **Filed: Jun. 4, 1986**

Related U.S. Application Data

- [63] Continuation of Ser. No. 651,927, Sep. 19, 1984, which is a continuation of Ser. No. 652,059, Sep. 19, 1984.
- [52] **U.S. Cl. D7/379; D7/376**
- [58] **Field of Search D7/376-384, D7/386, 412; D19/53; D24/41; D28/58; D32/17; 4/446; 15/3.15, 3.53, 22 R; 128/49; 173/163; 382/280; 320/2; 366/129, 342-344; 416/122; 433/131; 446/138**

References Cited

U.S. PATENT DOCUMENTS

D. 147,207	7/1947	Preble, Jr.	D7/379
D. 161,454	1/1951	Iannelli	D7/379
D. 162,833	4/1951	Iannelli	D7/379
D. 165,747	1/1952	Gemmill	D7/379
D. 174,161	3/1955	Corbett	D7/379
D. 175,263	8/1955	Lambert	D7/379
D. 186,922	12/1959	Streich et al.	D19/53
D. 219,110	11/1970	Stut	D7/379
D. 236,286	8/1975	McNair	D24/41
D. 256,171	7/1980	Tomaro	D28/58
D. 262,257	12/1981	Sohn	D32/17
D. 263,671	4/1982	Chan	D7/379
D. 271,176	11/1983	Zimnowicz	D7/379
D. 277,923	3/1985	Kafka	D7/379
D. 278,506	4/1985	Kafka	D7/379 X
D. 279,855	7/1985	Elkerbout	D7/376
D. 279,856	7/1985	Elkerbout	D7/379
873,123	12/1907	Gardy	128/49
1,091,585	3/1914	Motter	15/3.15
1,407,789	2/1922	Erhardt	366/344
2,483,727	10/1949	Frisbie	173/163
2,525,338	10/1950	Brown et al.	416/122

2,632,635	3/1953	Van Guilder	366/129
2,932,494	4/1960	Wales	366/129 X
2,987,636	6/1961	Jepson	366/129 X
3,183,891	5/1965	MacDonald	15/3.53
3,224,142	12/1965	Pawelka et al.	446/138
3,466,687	9/1969	Pasculli	15/3.53
3,640,641	2/1972	Fitzhugh	D7/379 X
3,774,255	11/1973	Pao	4/446
4,050,003	9/1977	Owings et al.	320/2
4,050,528	9/1977	Foltz et al.	173/163
4,137,588	2/1979	Sandt et al.	15/22 R
4,355,977	10/1982	Ota et al.	433/131
4,530,606	7/1985	Hopkins et al.	366/129
4,544,278	10/1985	Elkerbout et al.	366/129
4,575,255	3/1986	Kafka	366/129

FOREIGN PATENT DOCUMENTS

950531	7/1974	Canada .
1126082	3/1962	Fed. Rep. of Germany .
3306989	8/1984	Fed. Rep. of Germany .
3307023	8/1984	Fed. Rep. of Germany .
3308134	9/1984	Fed. Rep. of Germany .

Primary Examiner—Bernard Ansher
Assistant Examiner—Linda Titolo
Attorney, Agent, or Firm—Harness, Dickey & Pierce

[57] **CLAIM**

The ornamental design for a combined kitchen appliance and base assembly, as shown and described.

DESCRIPTION

FIG. 1 is a top front and left side perspective view of a combined kitchen appliance and base assembly showing my new design, the broken lines indicating four attachment members are shown for illustrative purposes only; FIG. 2 is a top perspective view thereof, the broken lines indicating a fragmentary portion of a wall are shown for illustrative purposes only; FIG. 3 is a front elevational view thereof; FIG. 4 is a rear elevational view thereof; FIG. 5 is a right side elevational view thereof; FIG. 6 is a left side elevational view thereof; and FIG. 7 is a top plan view thereof. The bottom plan view is unornamented and does not form part of the claimed design.

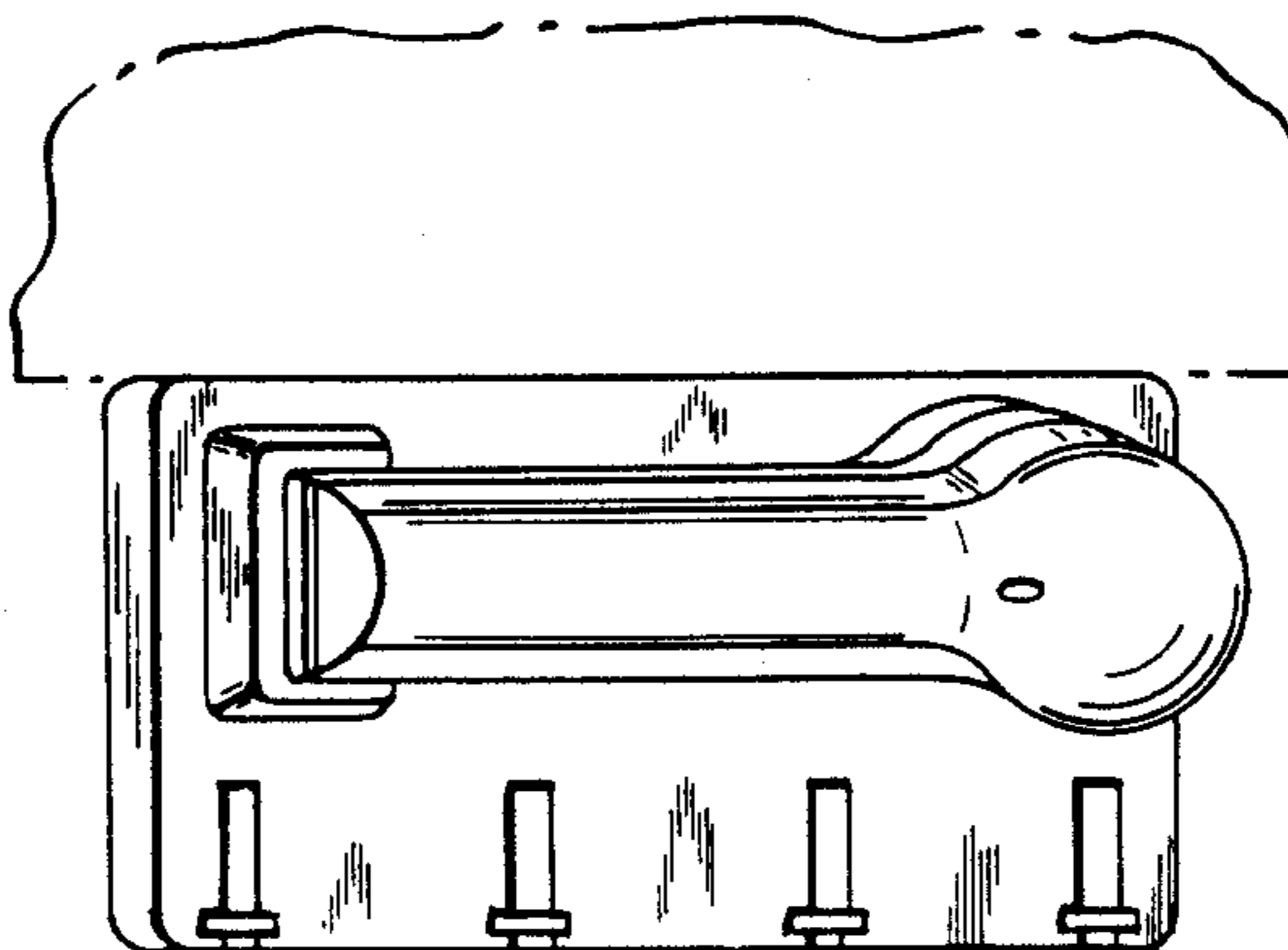

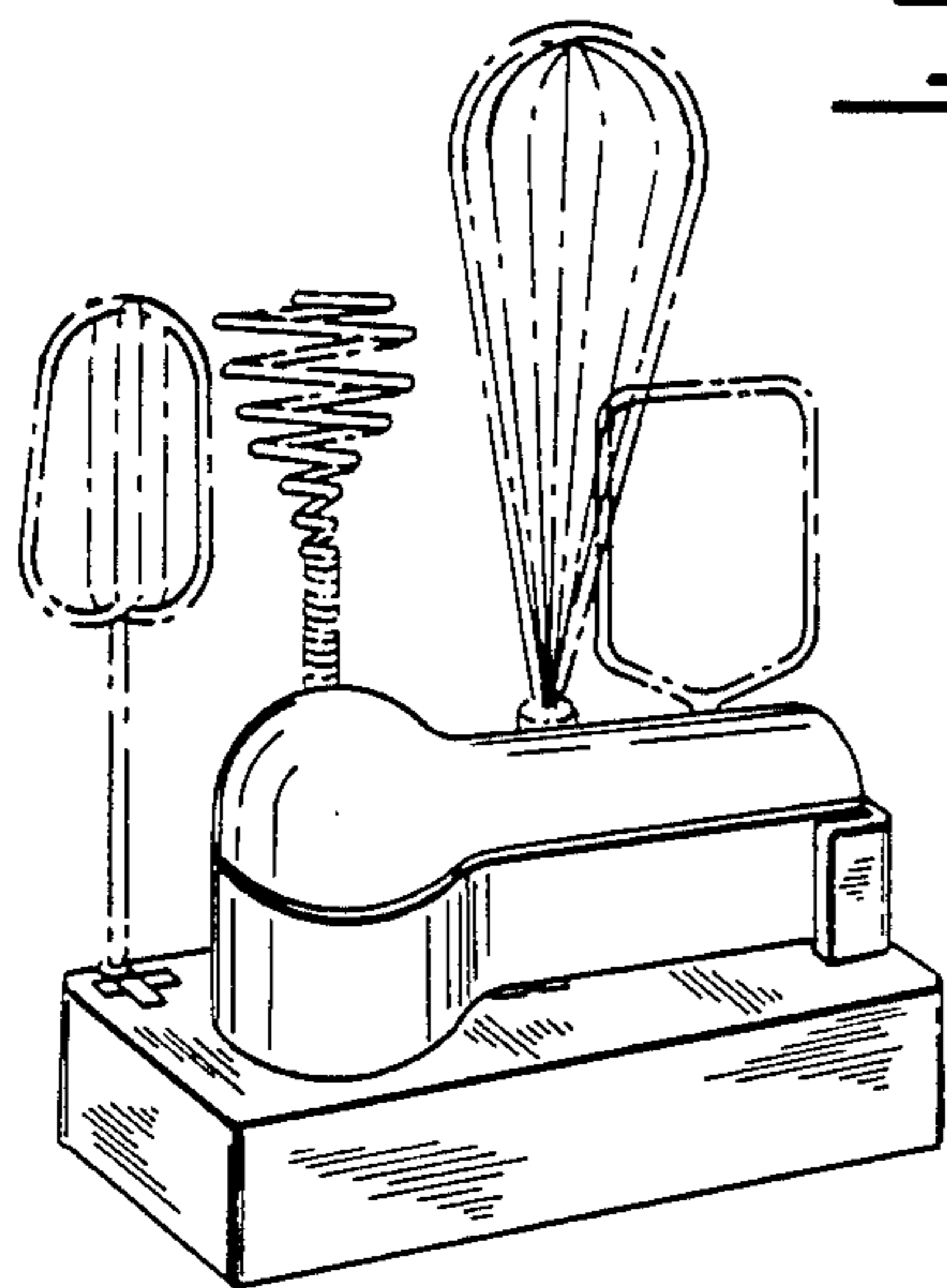

FIG. 1.

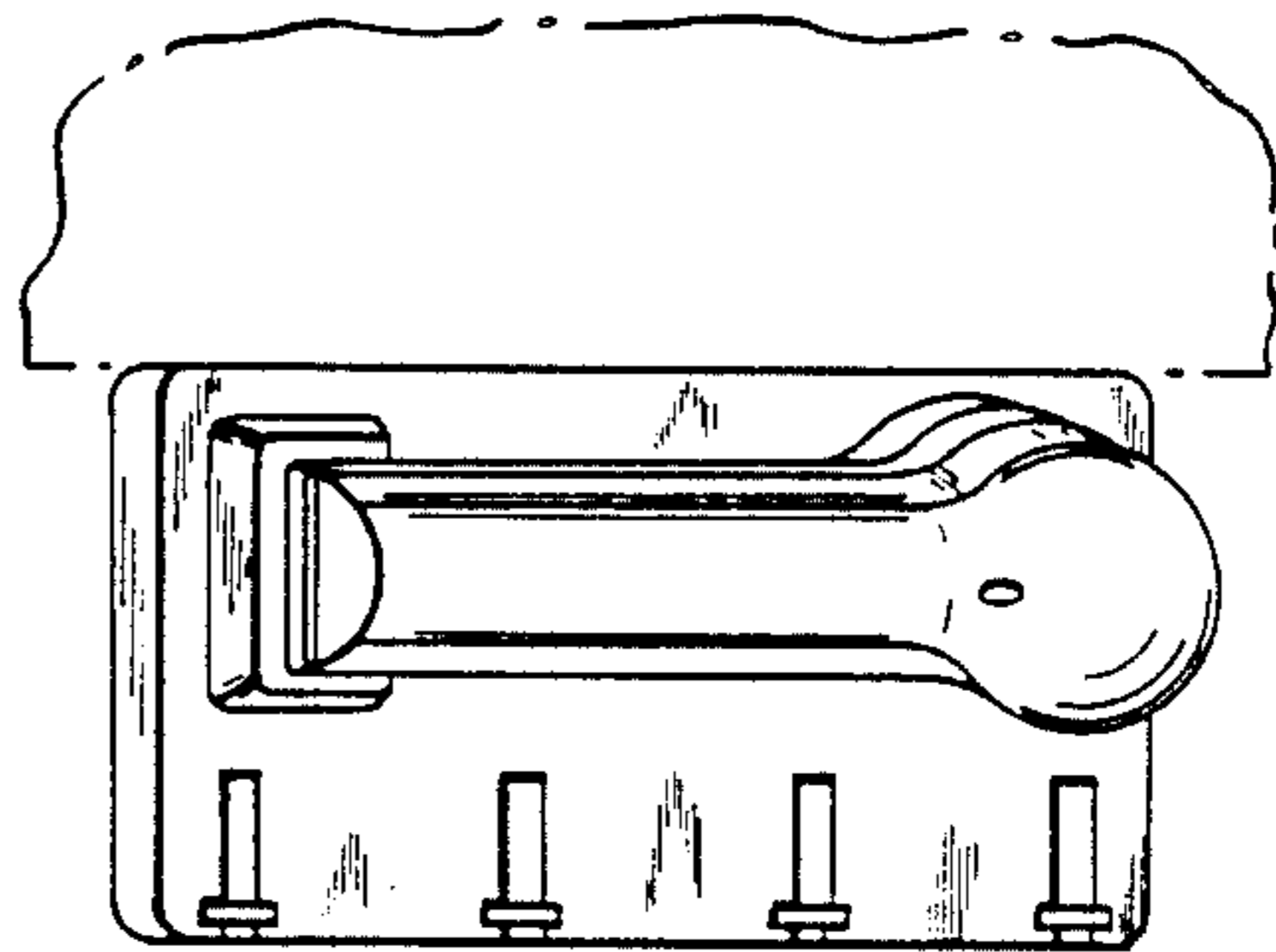

FIG. 2.

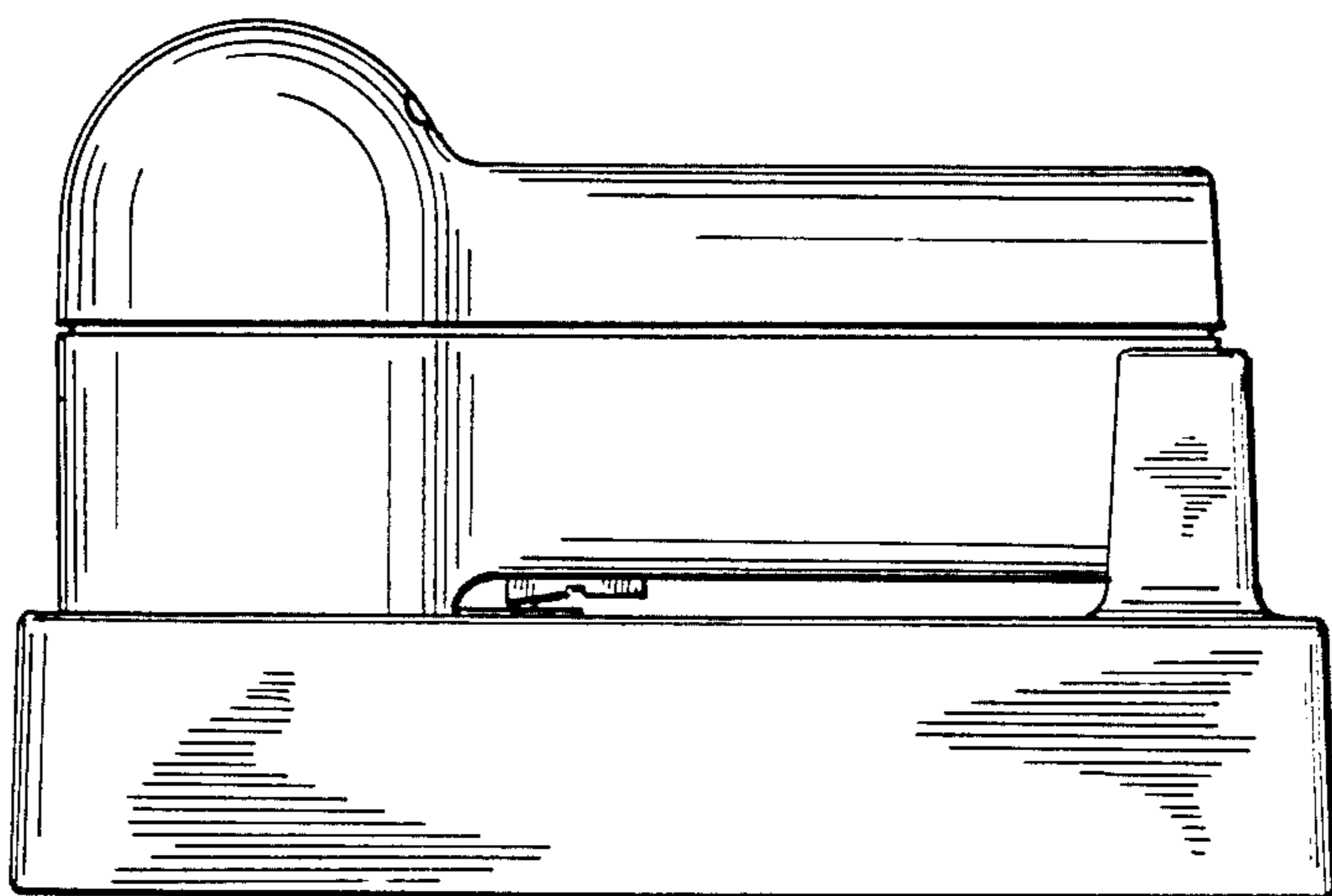

FIG. 3.

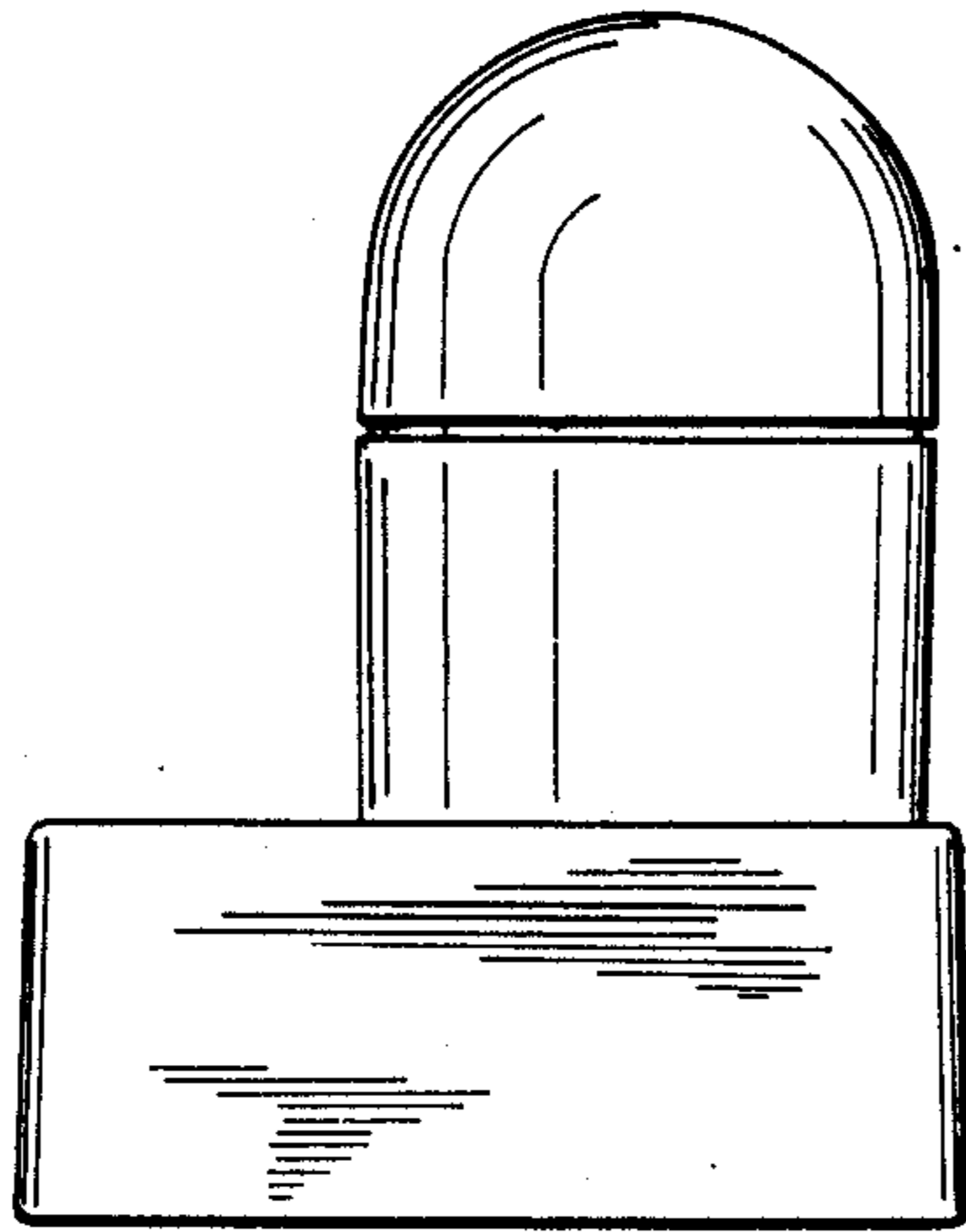
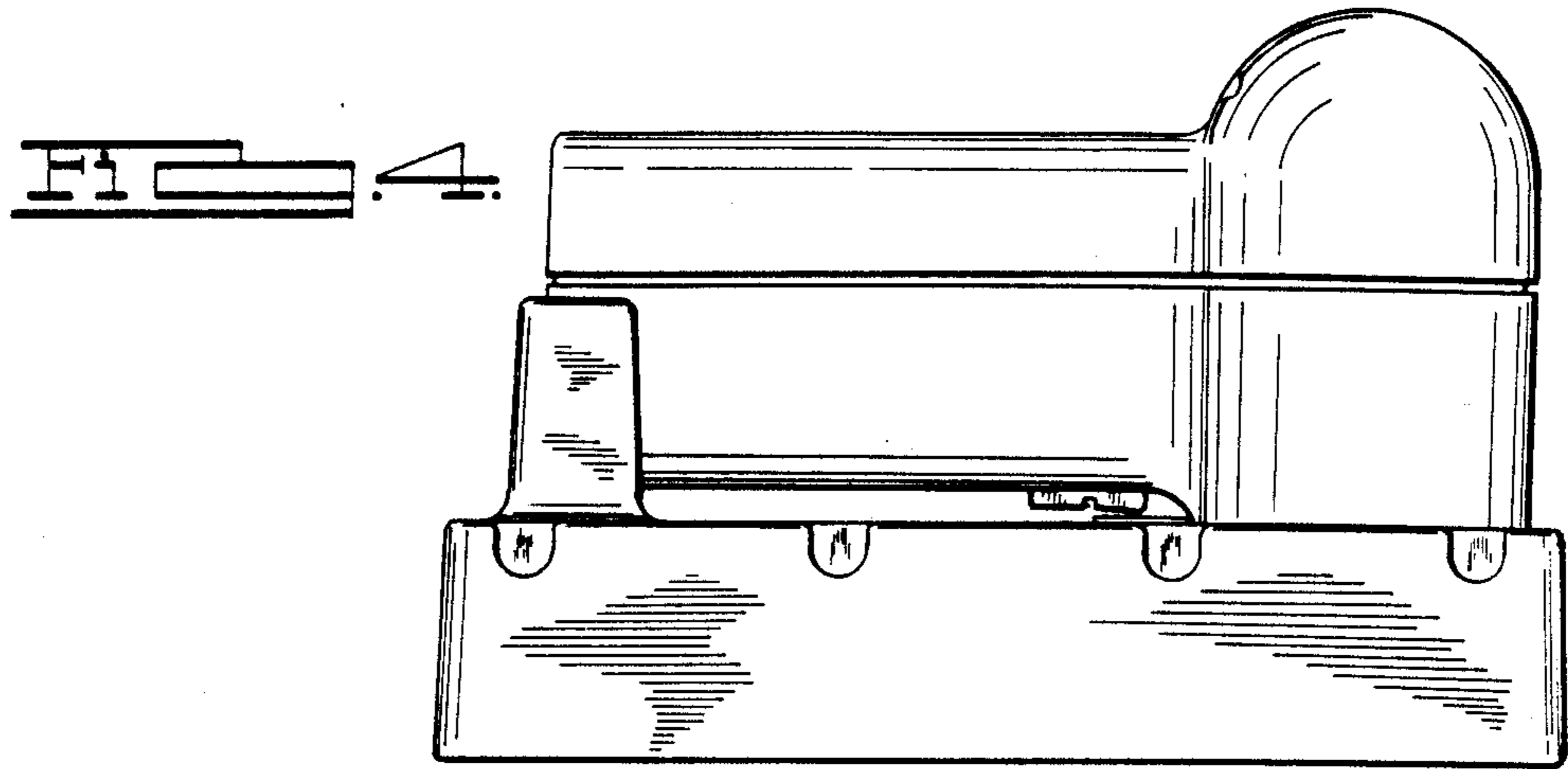

Fig. 5.

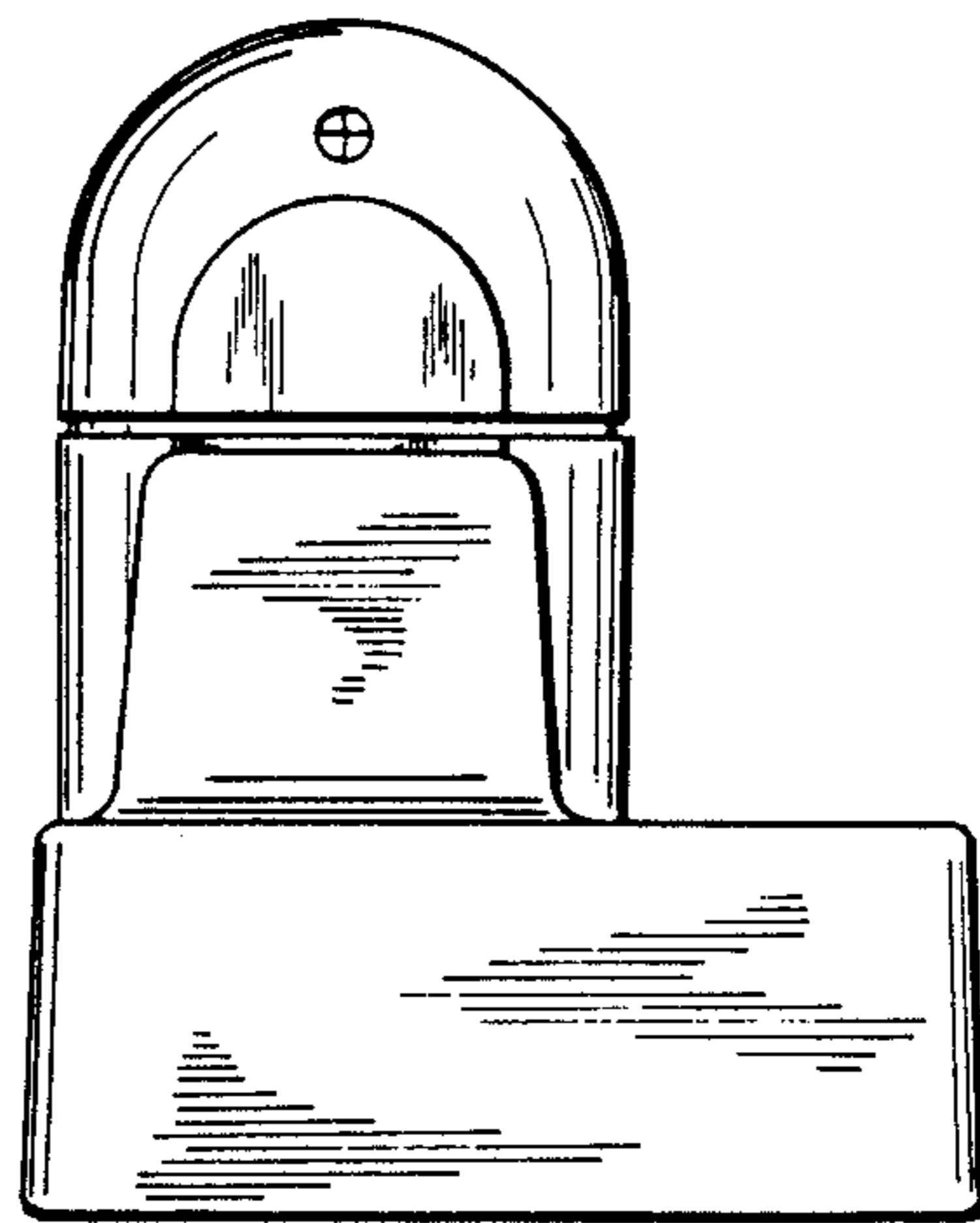

Fig. 6.

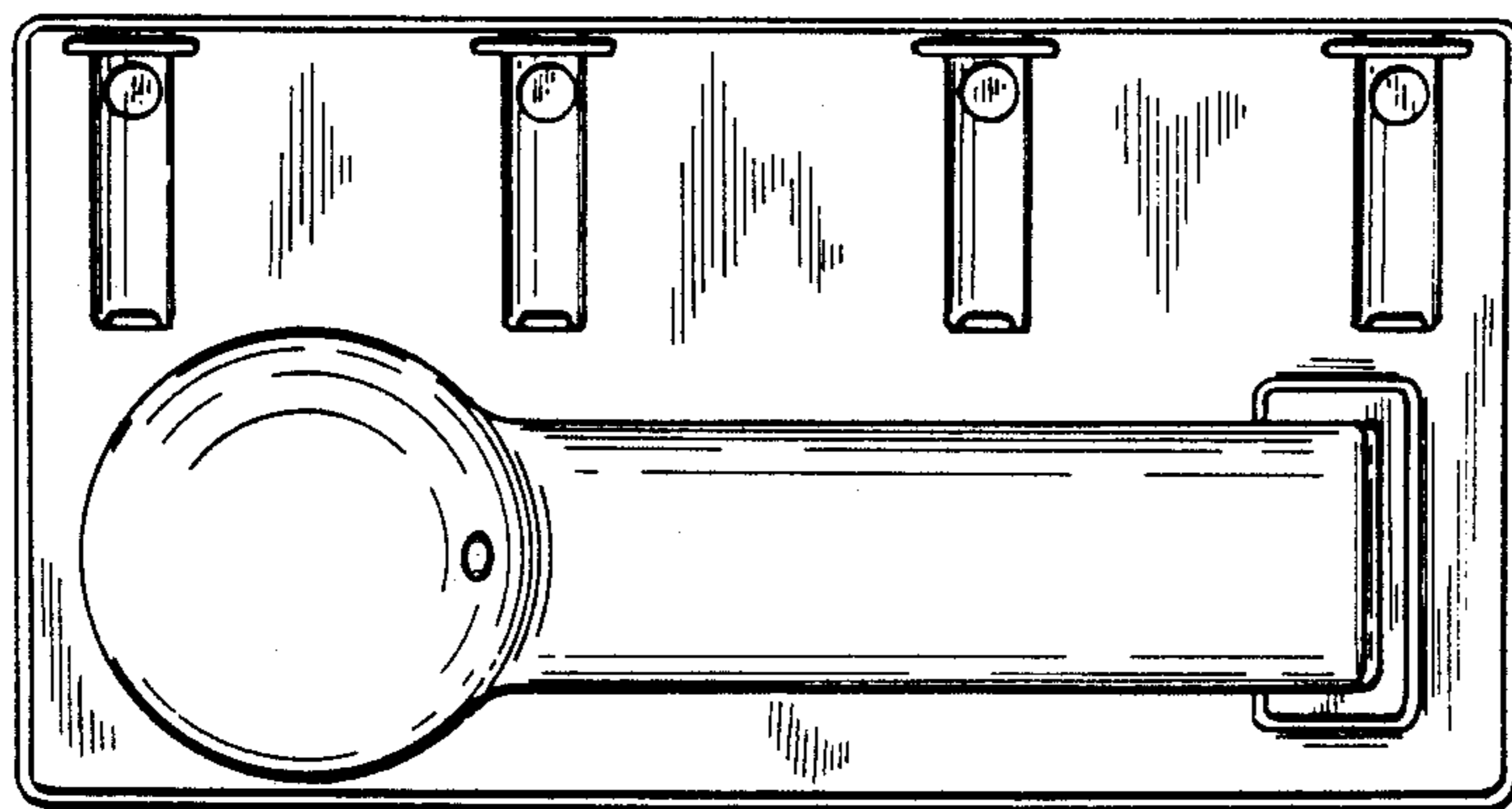

Fig. 7.