

[54] GRID-LIKE GUARD FOR THE FRONT OF A PORTABLE HEATER

[75] Inventors: Nobuyuki Kojima; Youichi Sekigawa; Makoto Kobiyama, all of Niigata, Japan

[73] Assignee: Toshiba Heating Appliances Co., Ltd., Niigata, Japan

[\*\*] Term: 14 Years

[21] Appl. No.: 586,989

[22] Filed: Mar. 7, 1984

[30] Foreign Application Priority Data

Sep. 8, 1983 [JP]	Japan	58-38904
Sep. 8, 1983 [JP]	Japan	58-38905
Oct. 31, 1983 [JP]	Japan	58-169050[U]
Nov. 2, 1983 [JP]	Japan	58-170301[U]
Dec. 12, 1983 [JP]	Japan	58-53329
Dec. 12, 1983 [JP]	Japan	58-53330
[52] U.S. Cl.		D23/127
[58] Field of Search		126/93-97, 126/201; D23/122-124, 127

[56] References Cited  
U.S. PATENT DOCUMENTS

D. 275,881	10/1984	Nakamura	D23/123
D. 276,458	11/1984	Mori et al.	D23/123
D. 277,501	2/1985	Nakamura	D23/123
1,542,227	6/1925	Fisher et al.	126/201

Primary Examiner—Catherine E. Kemper  
Attorney, Agent, or Firm—Rey Eiler

[57] CLAIM

The ornamental design for a grid-like guard for the front of a portable heater, as shown and described.

DESCRIPTION

FIG. 1 is a top plan view of a grid-like guard for the front of a portable heater, showing our new design; FIG. 2 is a front elevational view thereof; FIG. 3 is a left end elevational view thereof; FIG. 4 is a rear elevational view thereof; FIG. 5 is a right end elevational view thereof; FIG. 6 is a bottom view thereof; FIG. 7 is a top plan view of a second embodiment of a grid-like guard for a portable heater; FIG. 8 is a front elevational view thereof; FIG. 9 is a left end elevational view thereof; FIG. 10 is a right end elevational view thereof; FIG. 11 is a rear perspective view thereof.

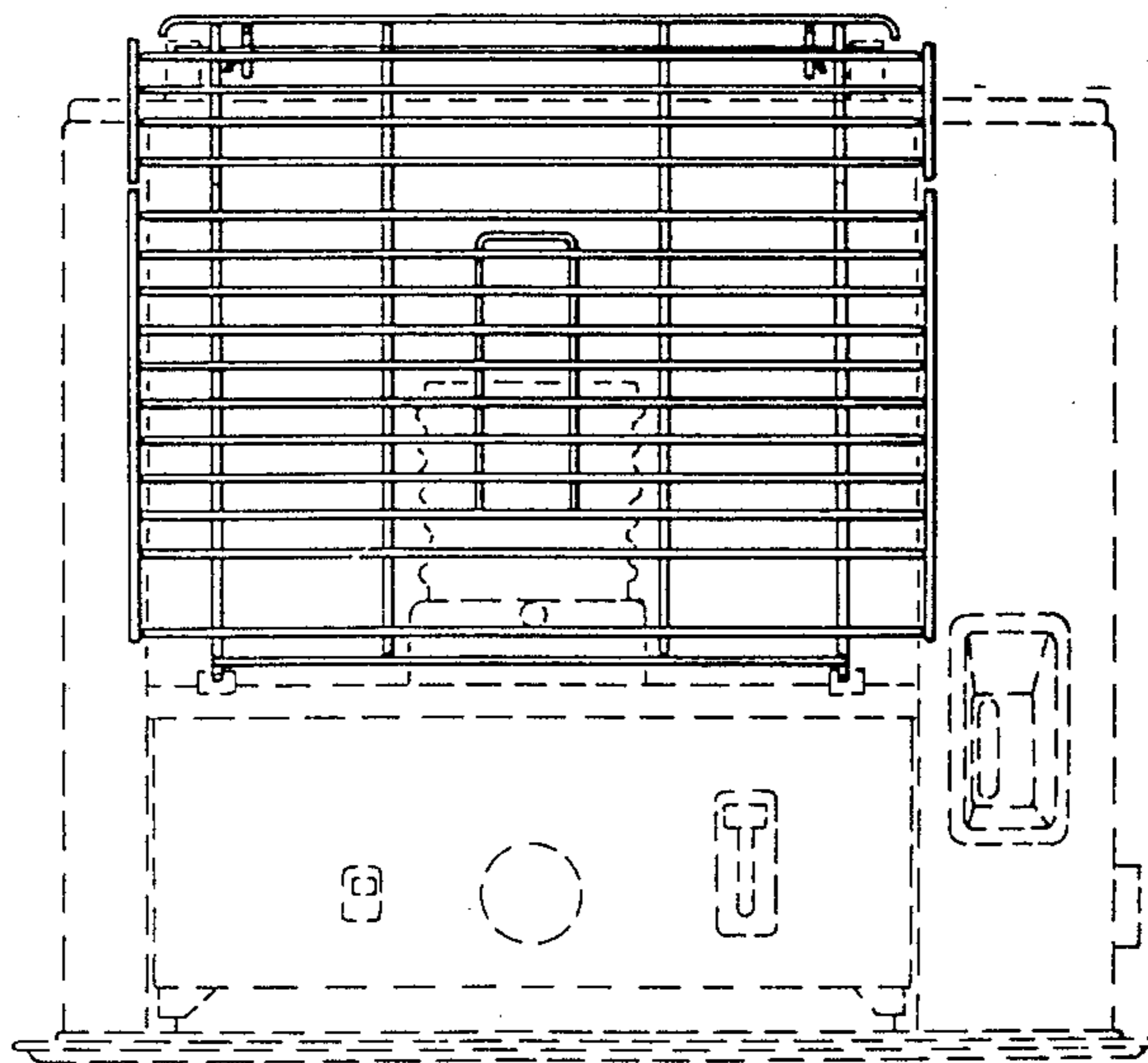

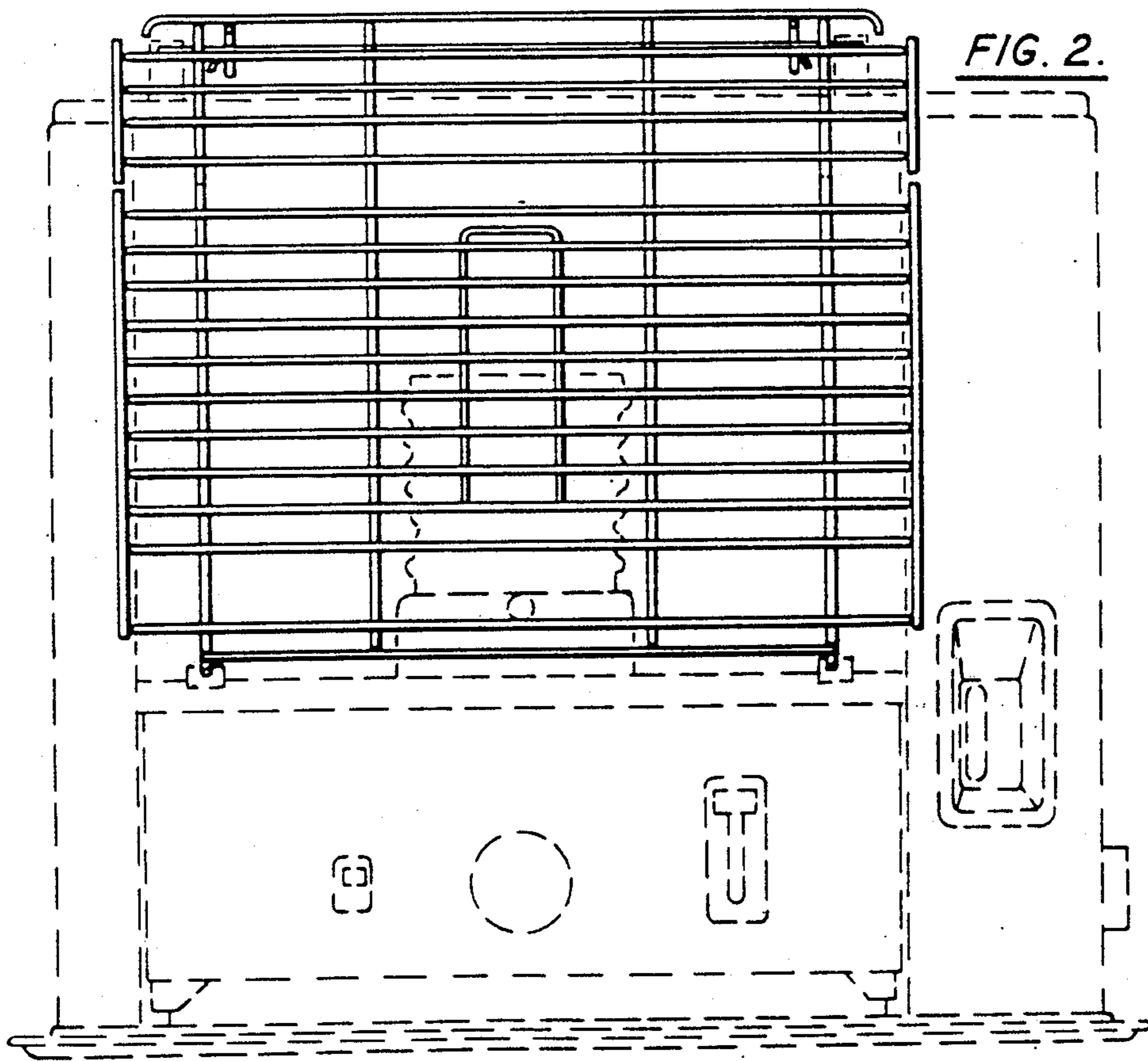
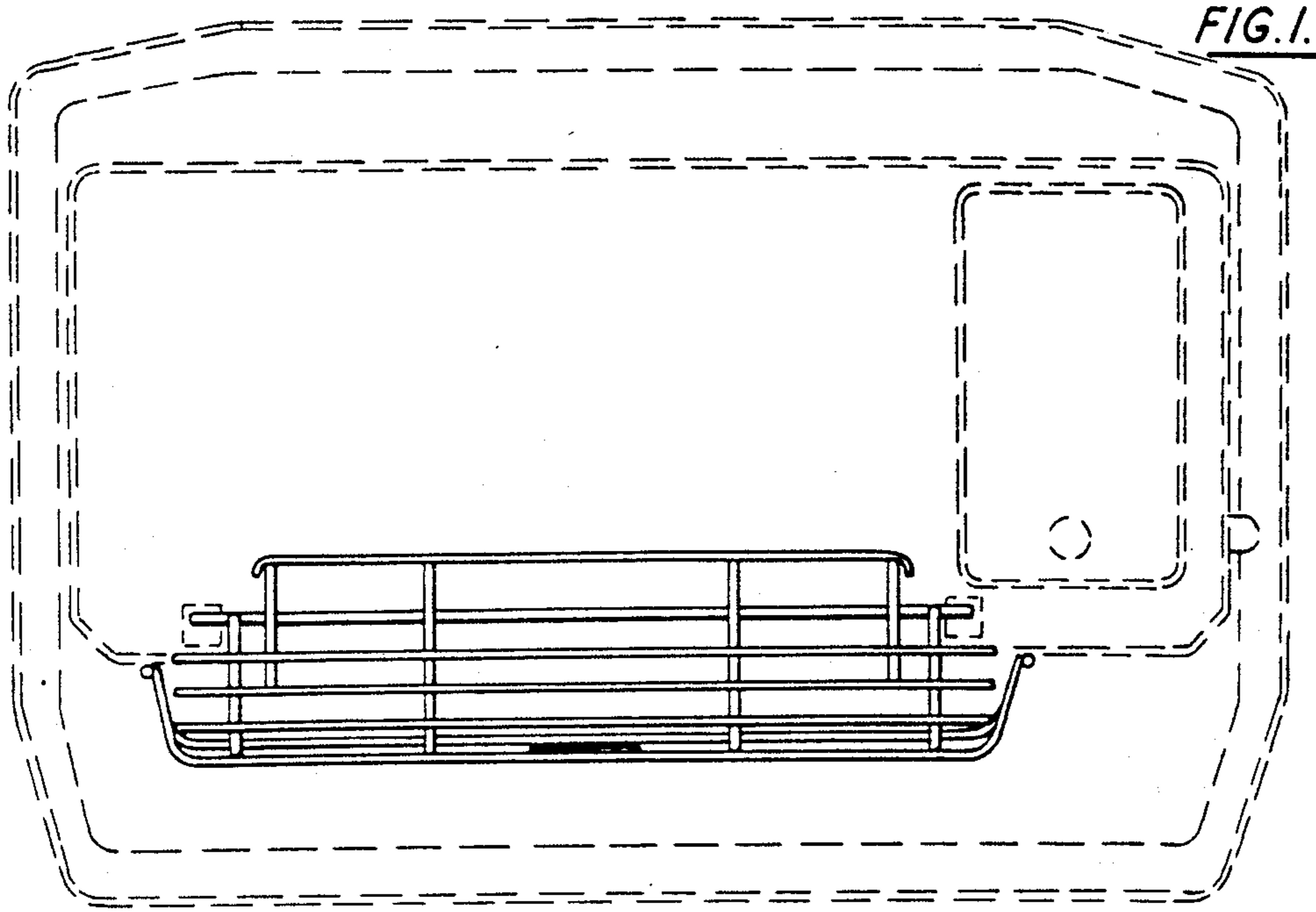

FIG. 4.

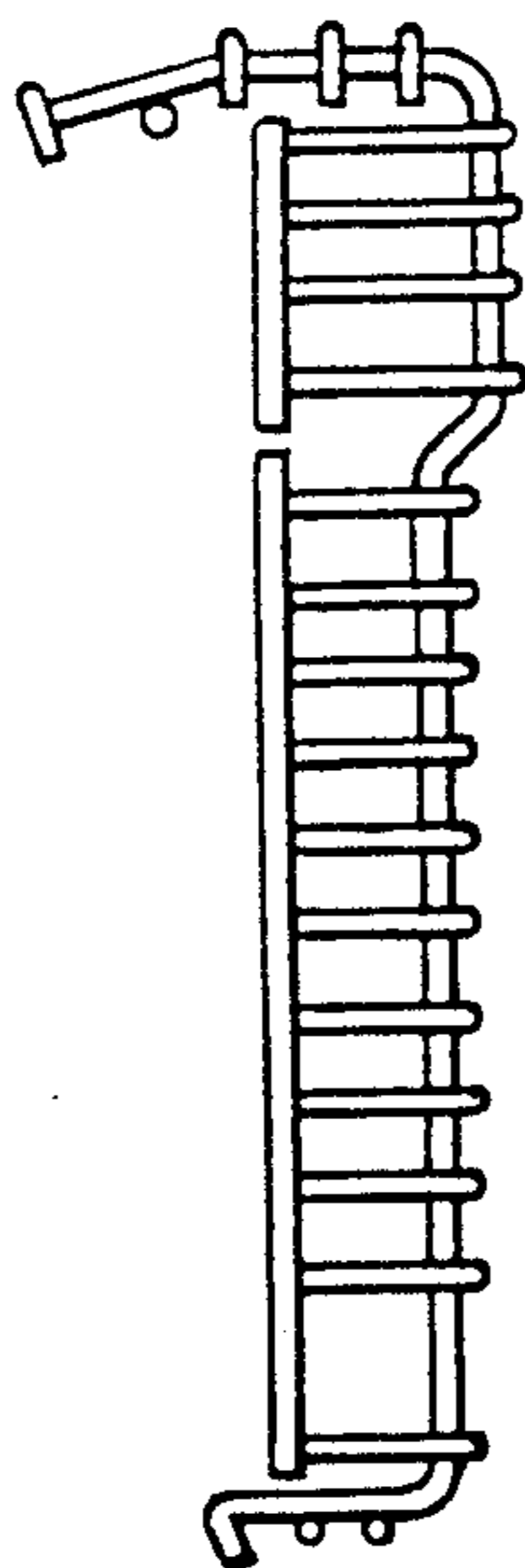
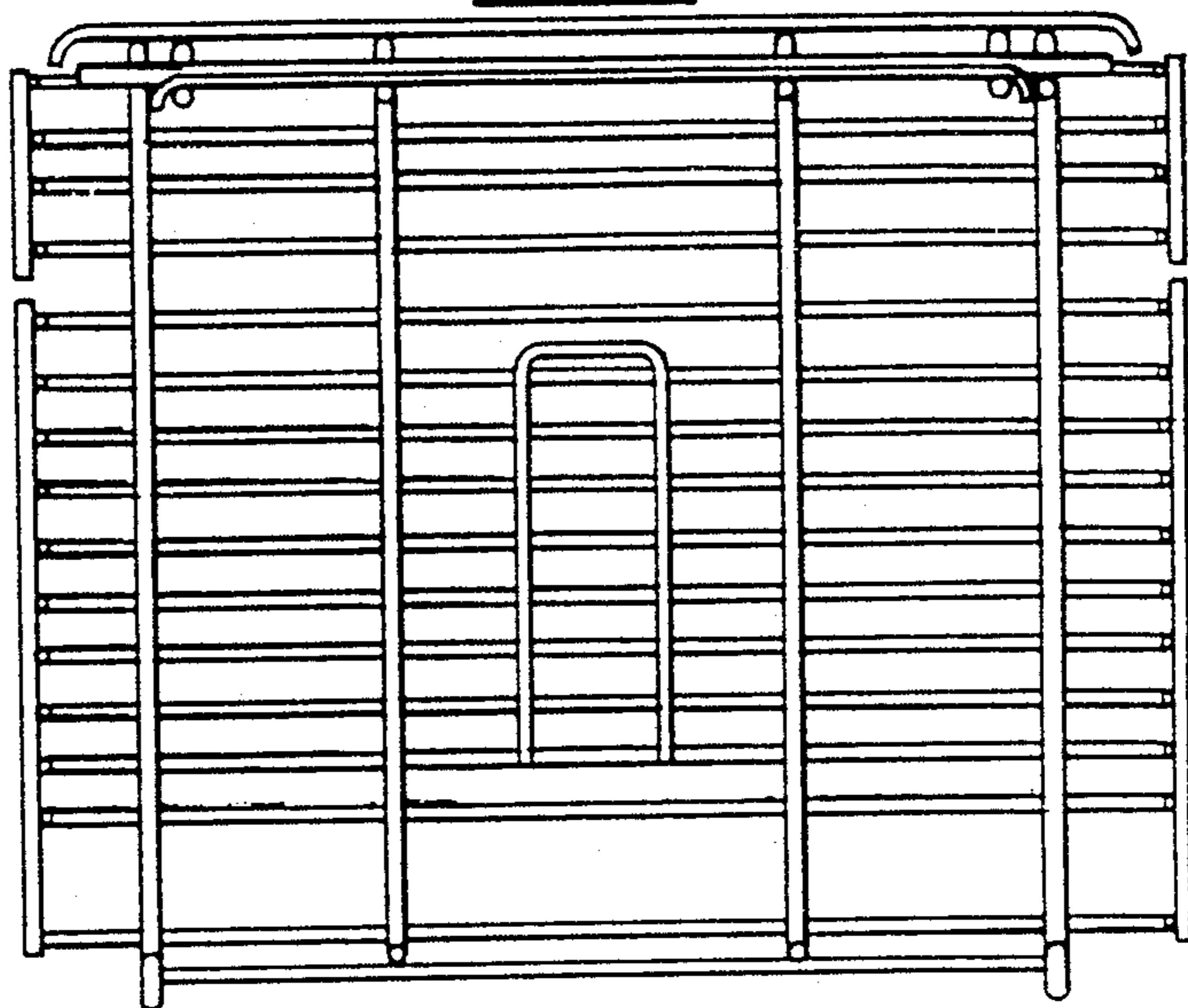

FIG. 3.

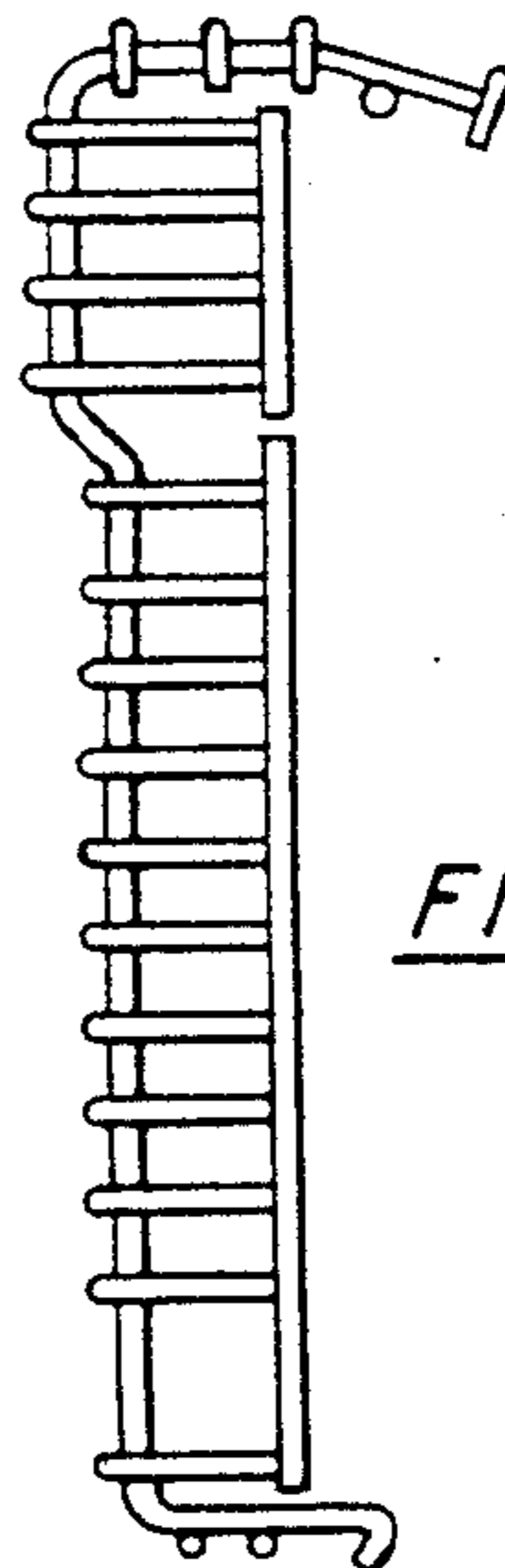

FIG. 5.

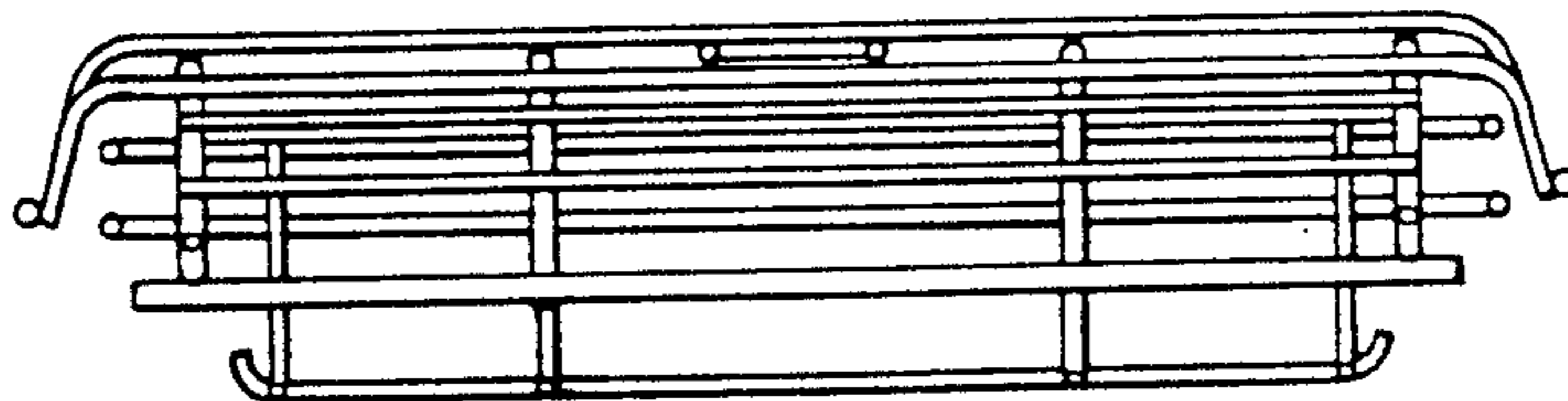

FIG. 6.

FIG. 7.

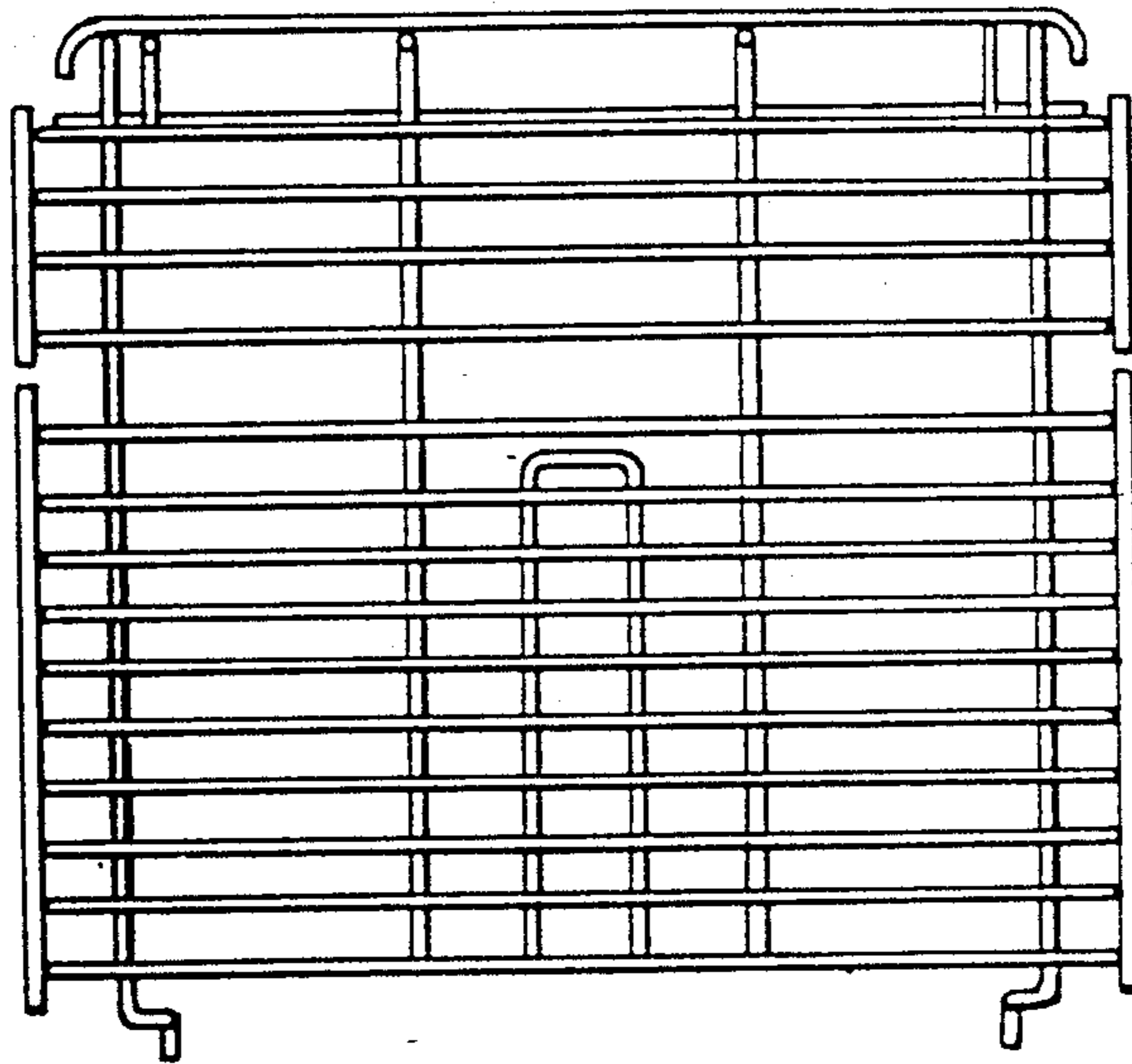
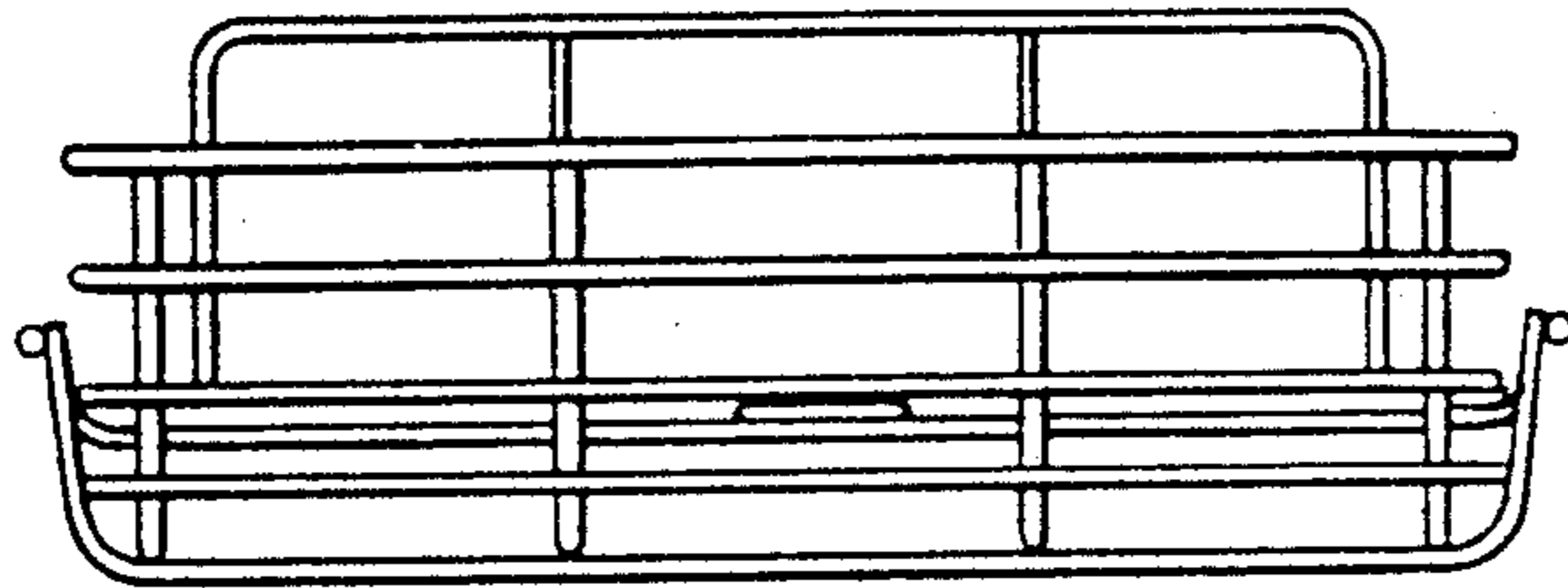

FIG. 8.

FIG. 11.

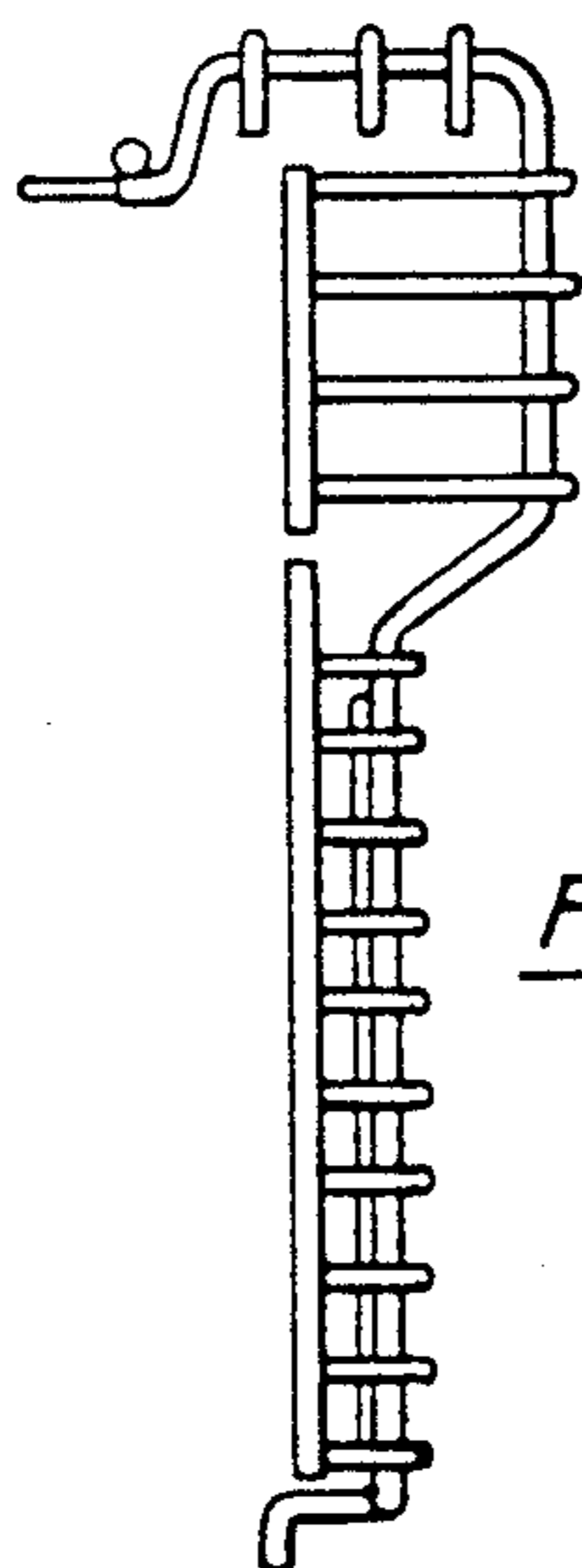
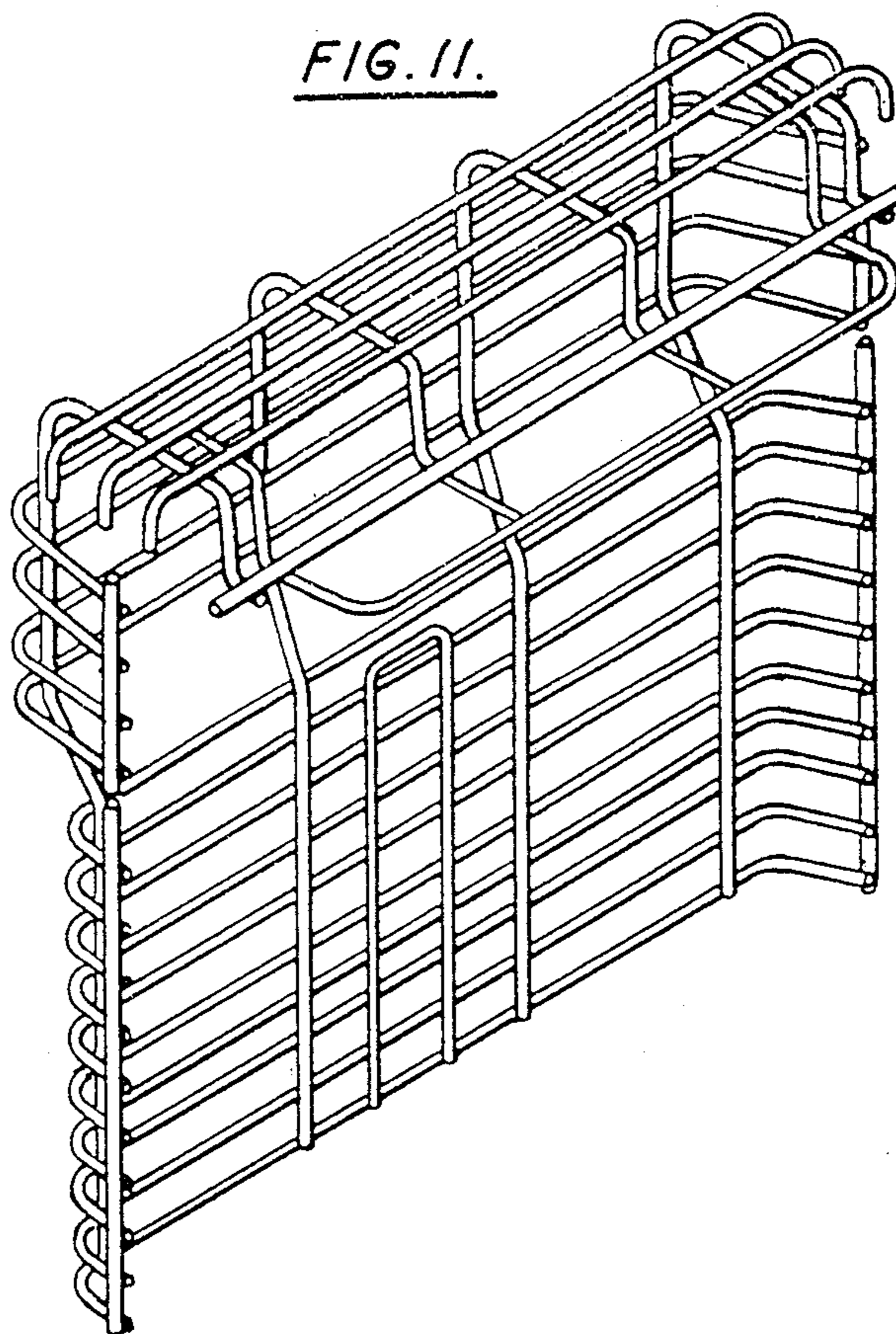

FIG. 9.

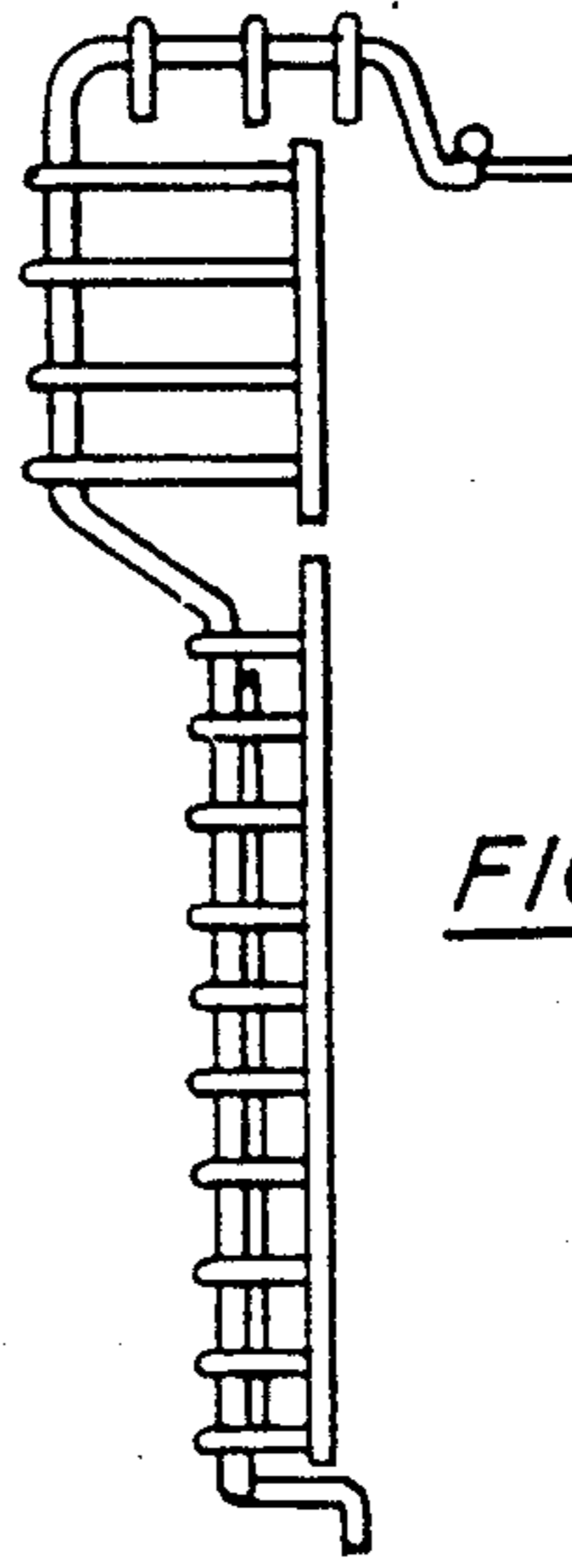

FIG. 10.