

[54] CONVERTIBLE HIGH CHAIR

[75] Inventors: Shinroku Nakao, Kanagawa; Yoshiyasu Ishii; Susumu Matsumoto, both of Tokyo, all of Japan

[73] Assignee: Combi Co., Ltd., Tokyo, Japan

[\*\*] Term: 14 Years

[21] Appl. No.: 670,848

[22] Filed: Nov. 13, 1984

[30] Foreign Application Priority Data

May 25, 1984 [JP] Japan ..... 59-21329

[52] U.S. Cl. .... D6/338; D6/339

[58] Field of Search ..... D6/333, 334, 339-367, D6/368; 297/118, 130, 153, 253, 255

[56] References Cited

U.S. PATENT DOCUMENTS

- D. 181,106 10/1957 Reguitti ..... D6/339
- D. 228,587 10/1973 Blazey et al. .... D6/339
- D. 246,682 12/1977 Nakao ..... D6/338

- D. 254,699 4/1980 Nakao et al. .... D6/338
- D. 261,828 11/1981 Nakao et al. .... D6/333
- D. 273,727 5/1984 Nakao et al. .... D6/333
- 3,649,074 3/1972 McDonald et al. .... 297/153

Primary Examiner—Bruce W. Dunkins  
Attorney, Agent, or Firm—Sughrue, Mion, Zinn, Macpeak, and Seas

[57] CLAIM

The ornamental design for a convertible high chair, as shown and described.

DESCRIPTION

FIG. 1 is a front, top and left side perspective view of a convertible high chair showing our new design; FIG. 2 is a front elevational view thereof; FIG. 3 is a right side elevational view thereof; FIG. 4 is a top plan view thereof; FIG. 5 is a left side elevational view thereof; FIG. 6 is a rear elevational view thereof; FIG. 7 is a bottom plan view thereof; and FIG. 8 is a front perspective view showing the high chair in its converted position for use as a baby chair.

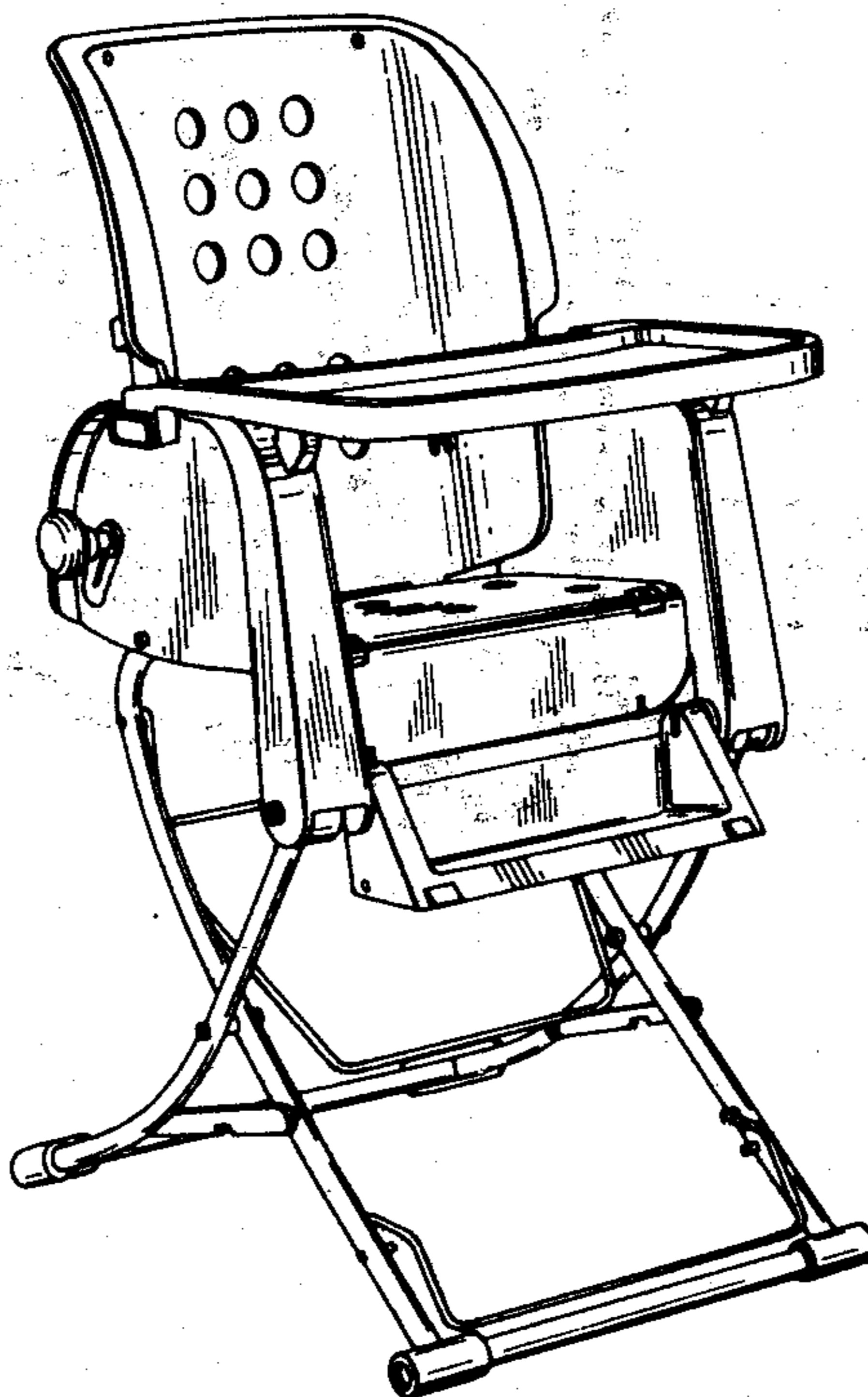

FIG. 2

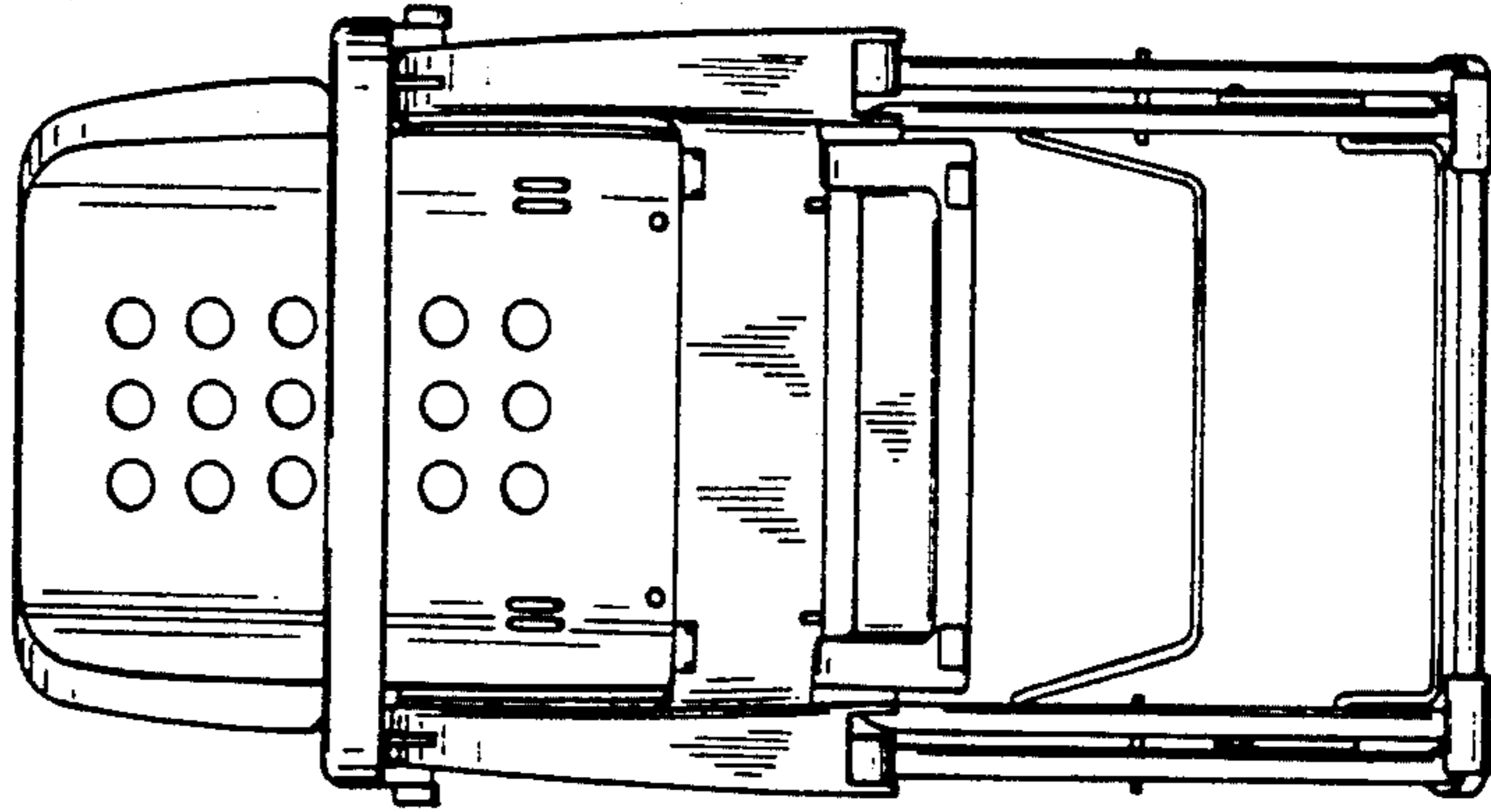

FIG. 1

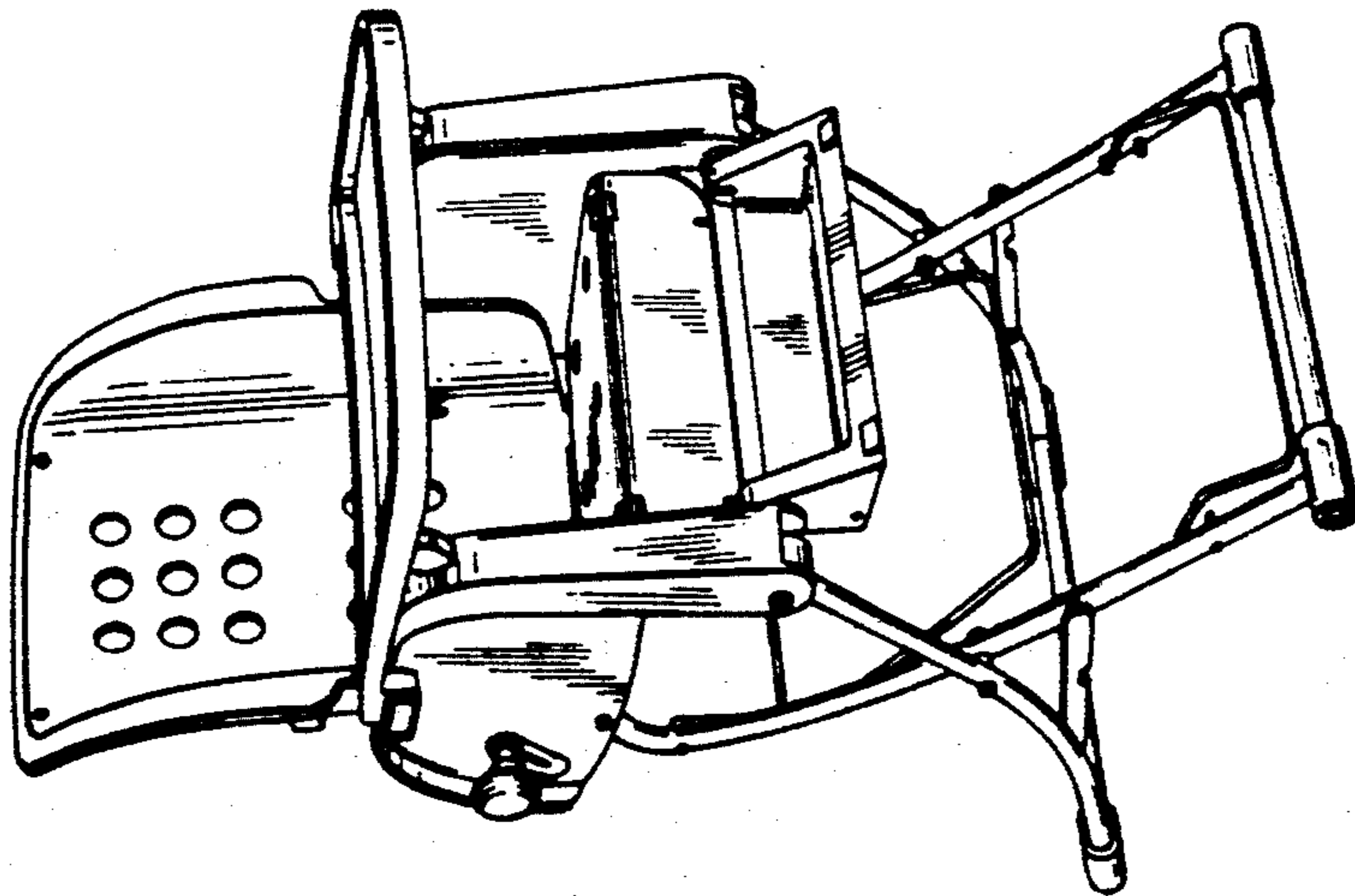

FIG. 4

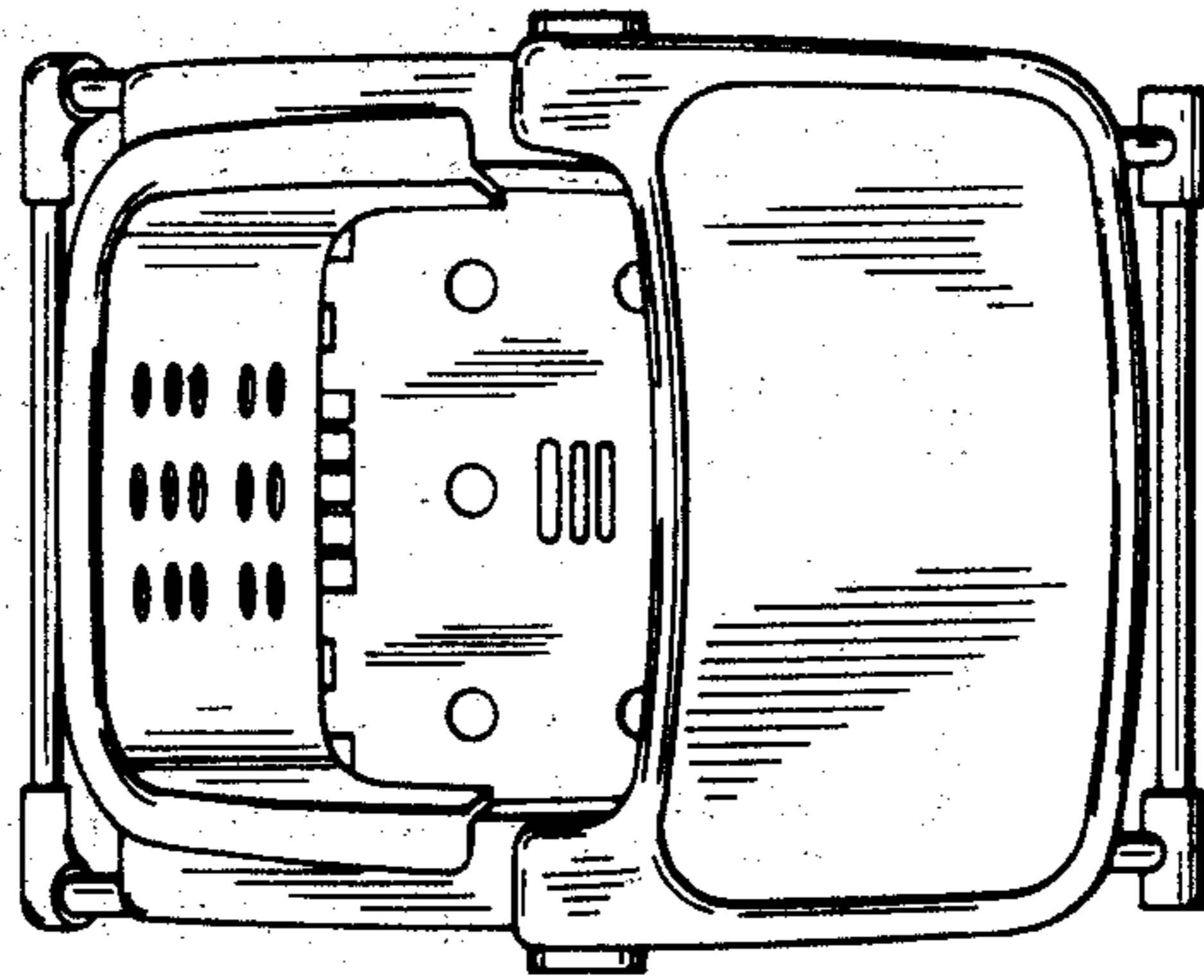

FIG. 3

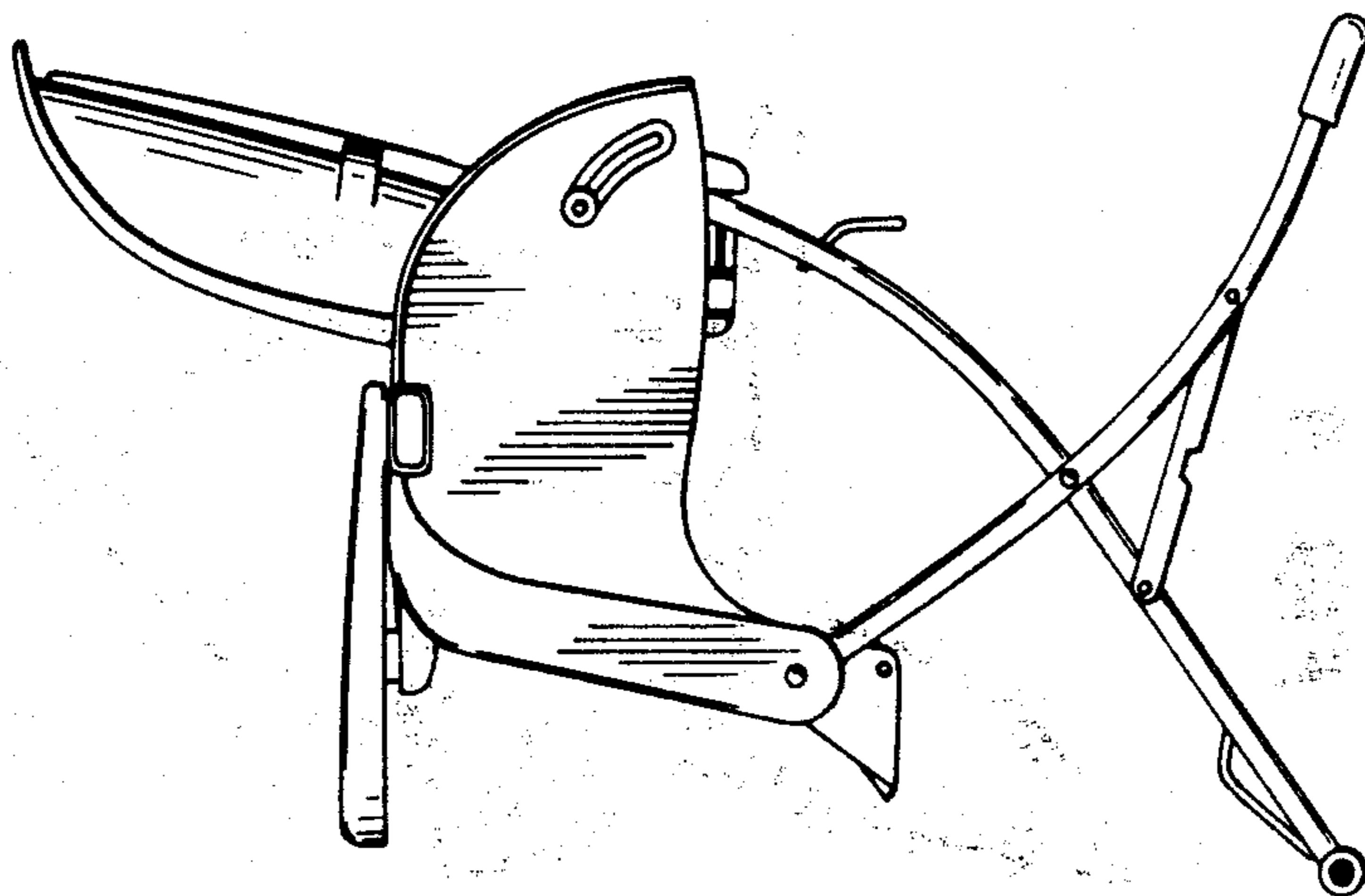

FIG. 6

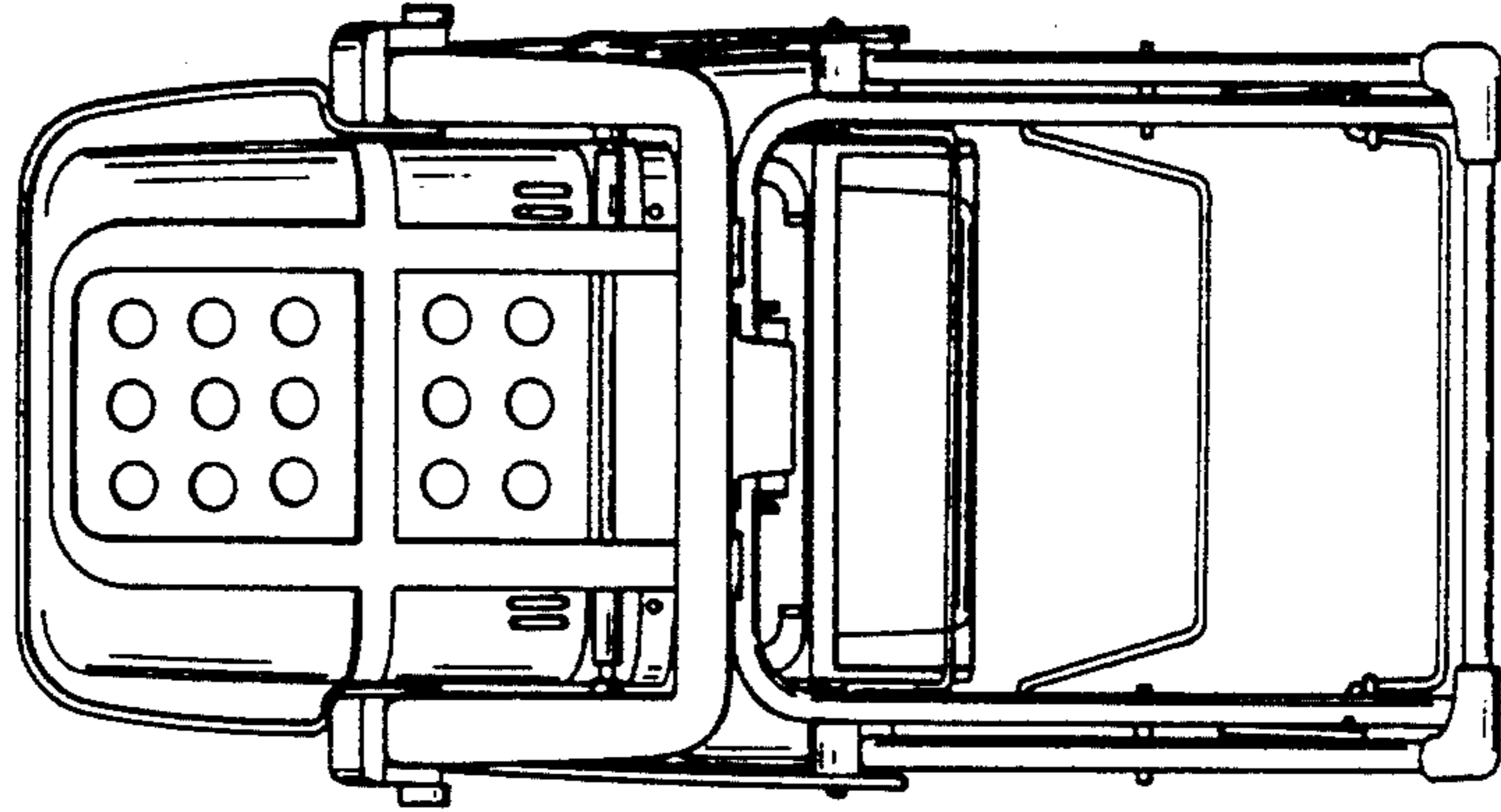

FIG. 5

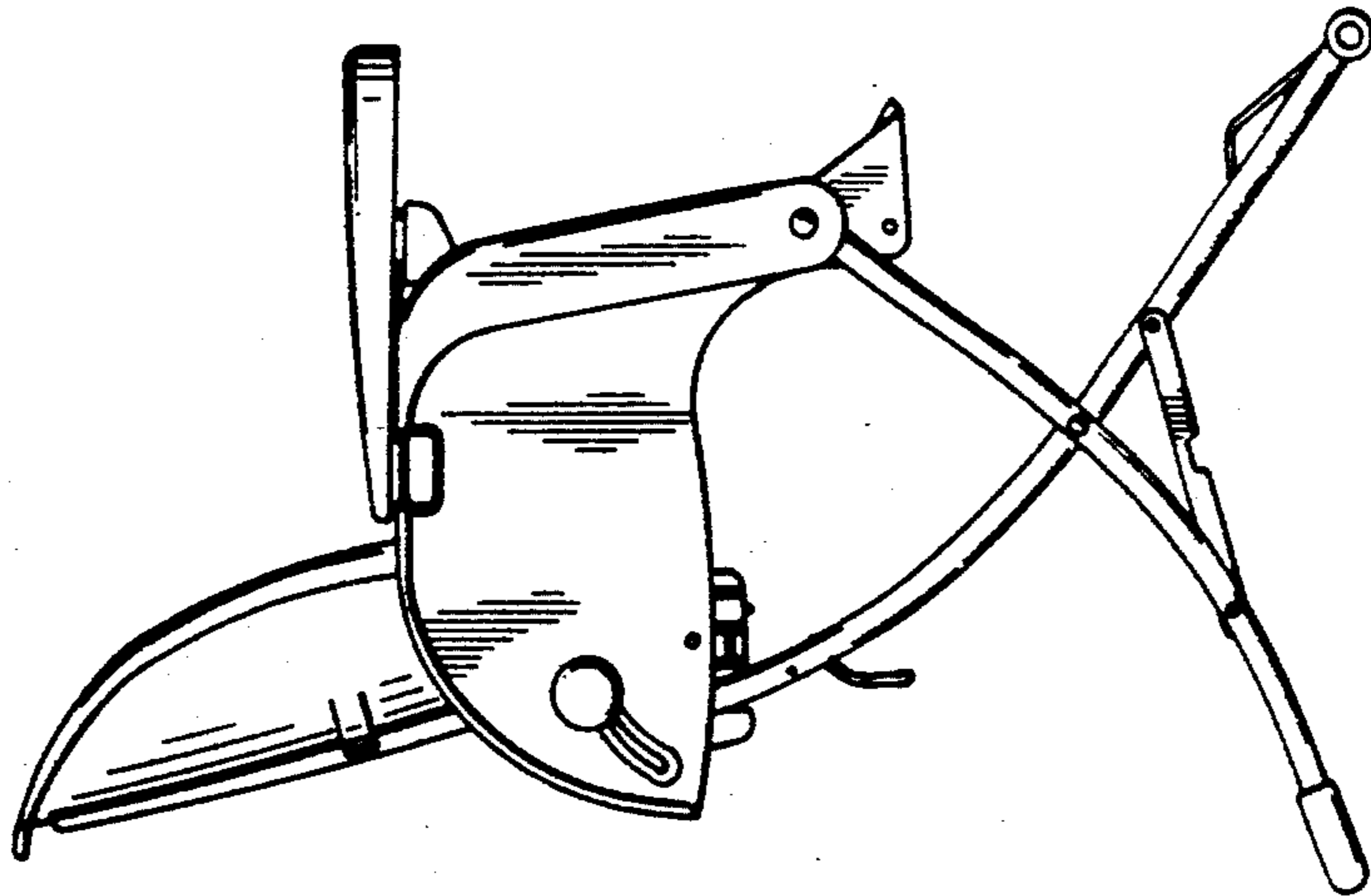

FIG. 8

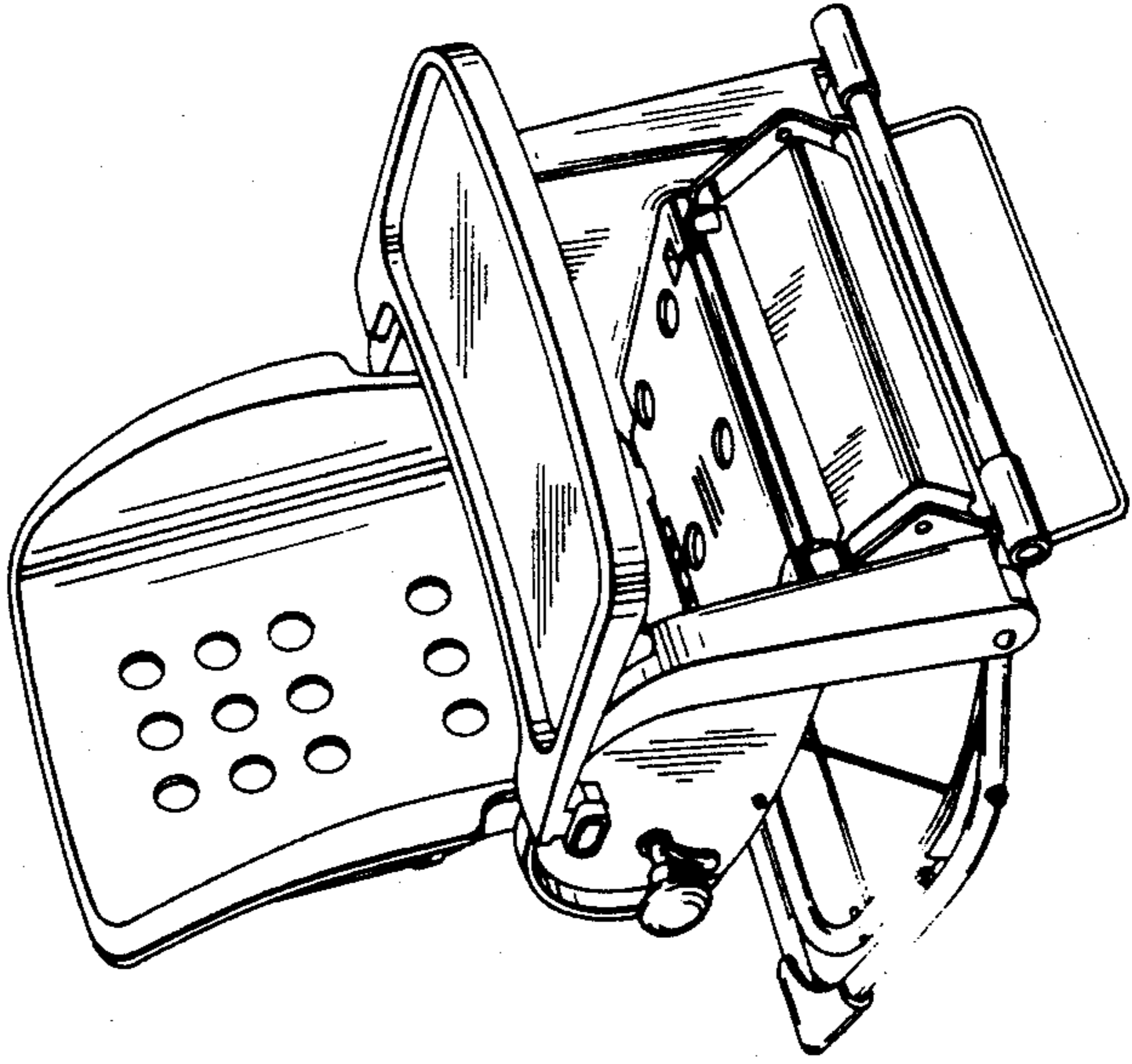

FIG. 7

