

[54] ELECTRIC IRON

[75] Inventor: Serge Brun, Lyons, France

[73] Assignee: Calor S.A., Lyons, France

[**] Term: 14 Years

[21] Appl. No.: 743,652

[22] Filed: Jun. 11, 1985

[30] Foreign Application Priority Data

Dec. 19, 1984 [FR] France 845720

[52] U.S. Cl. D32/70

[58] Field of Search D32/68-73;
38/69, 74, 75, 77.1-77.9, 88, 94, 96, 142;
219/245-259, 271-276

[56] References Cited

U.S. PATENT DOCUMENTS

D. 214,753 7/1969 Schellens D32/70

D. 240,997 8/1976 Julkenbeck D32/70
D. 262,771 1/1982 Hanson D32/70
D. 268,216 3/1983 Levin D32/70

Primary Examiner—Catherine E. Kemper
Attorney, Agent, or Firm—Young & Thompson

[57] CLAIM

The ornamental design for an electric iron, as shown and described.

DESCRIPTION

FIG. 1 is a side elevational view of an electric iron, showing my new design;
FIG. 2 is an elevational view of the opposite side thereof;
FIG. 3 is a rear elevational view thereof;
FIG. 4 is a front elevational view thereof;
FIG. 5 is a top plan view thereof;
FIG. 6 is a bottom plan view thereof;
FIG. 7 is a rear perspective view thereof; and
FIG. 8 is a front perspective view thereof.

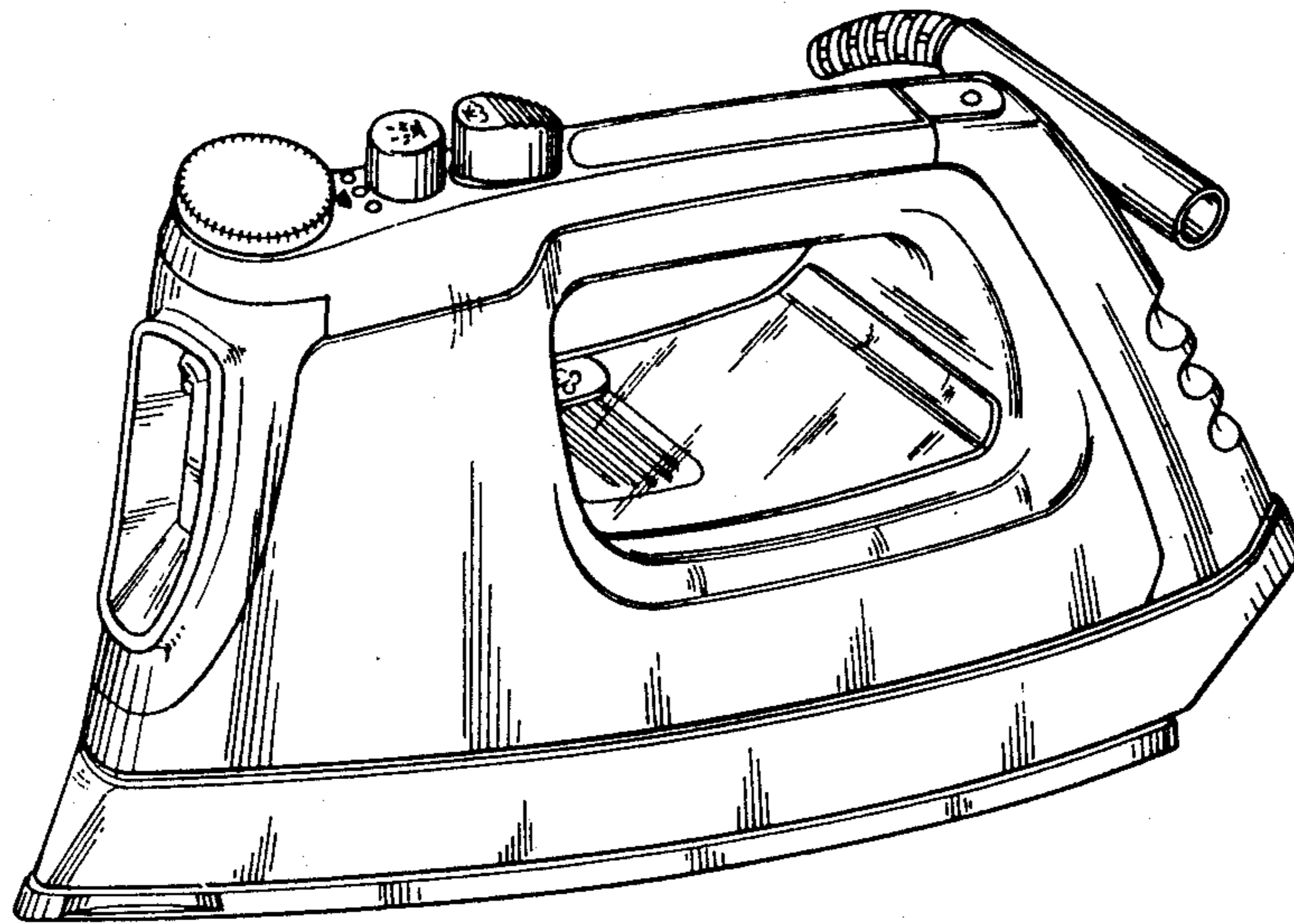

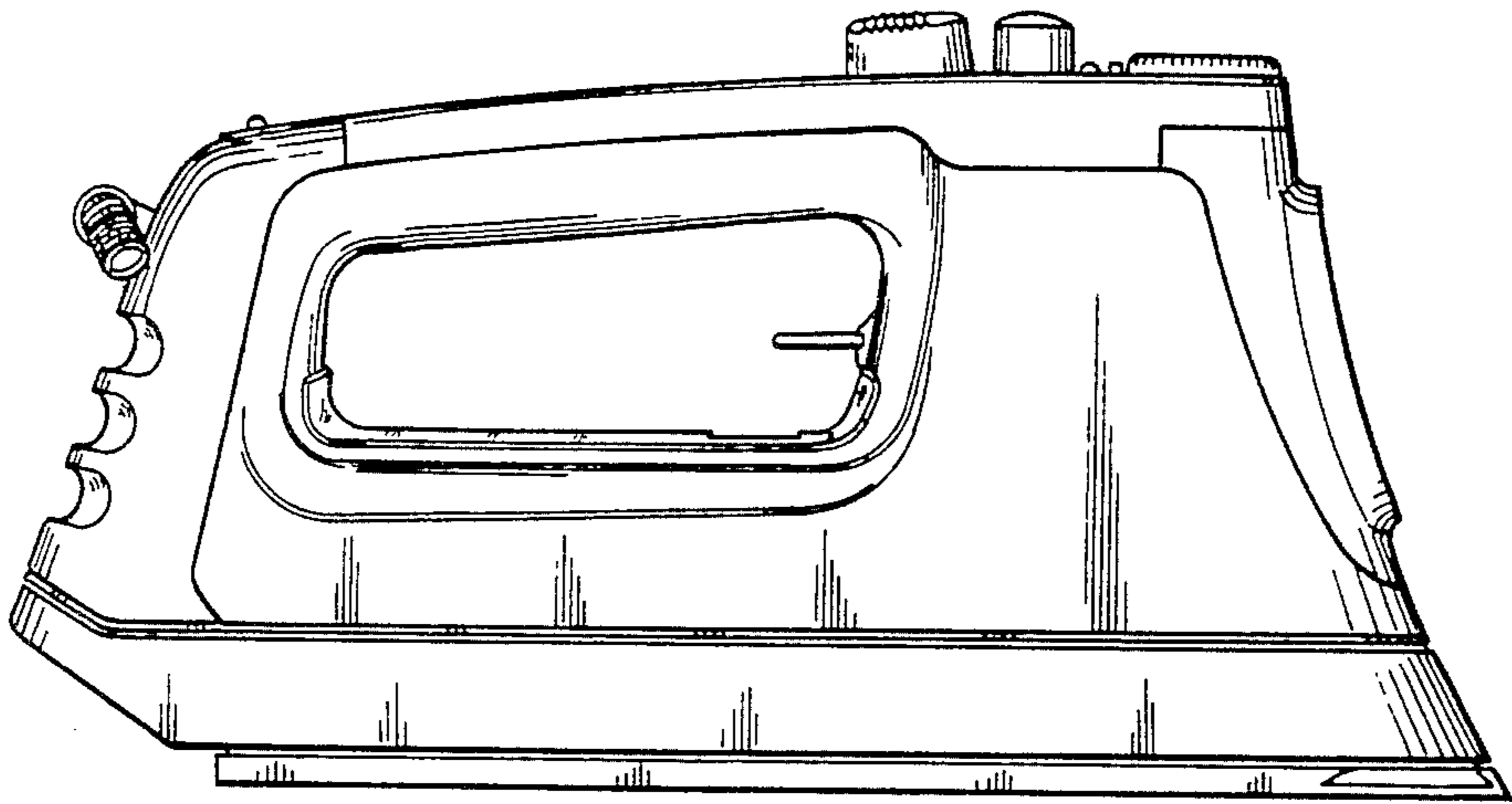

FIG. 1

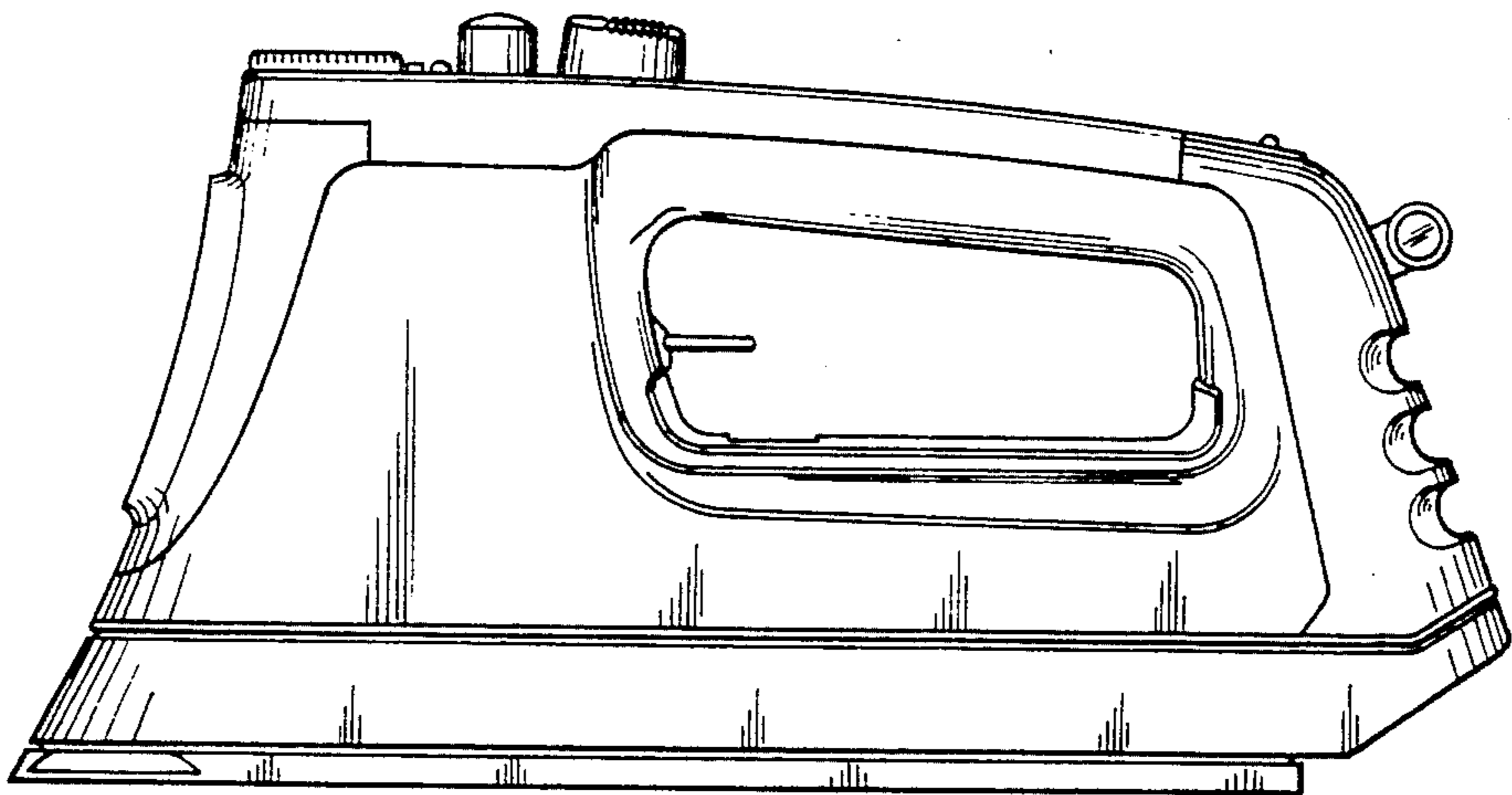

FIG. 2

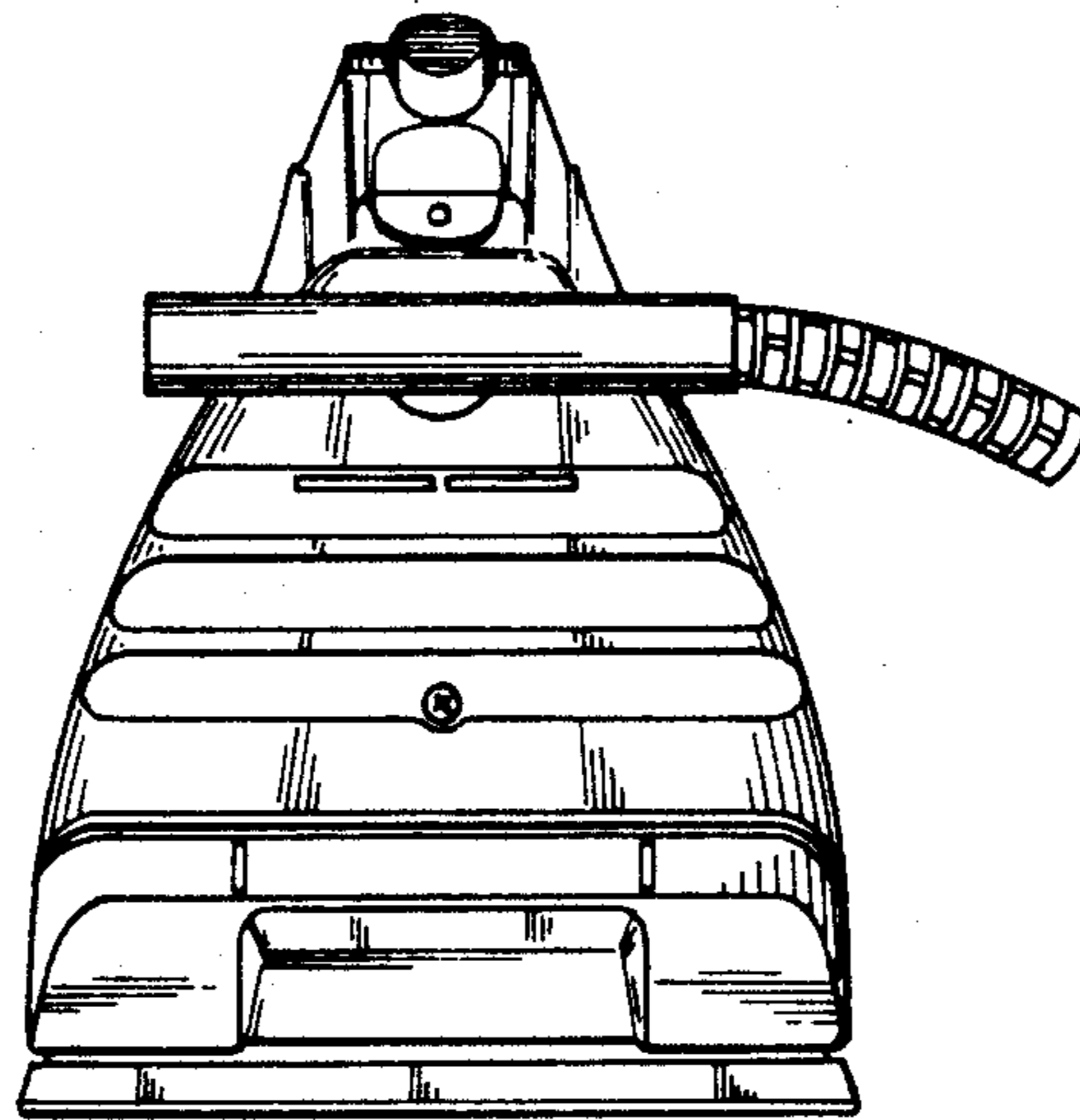

FIG. 3

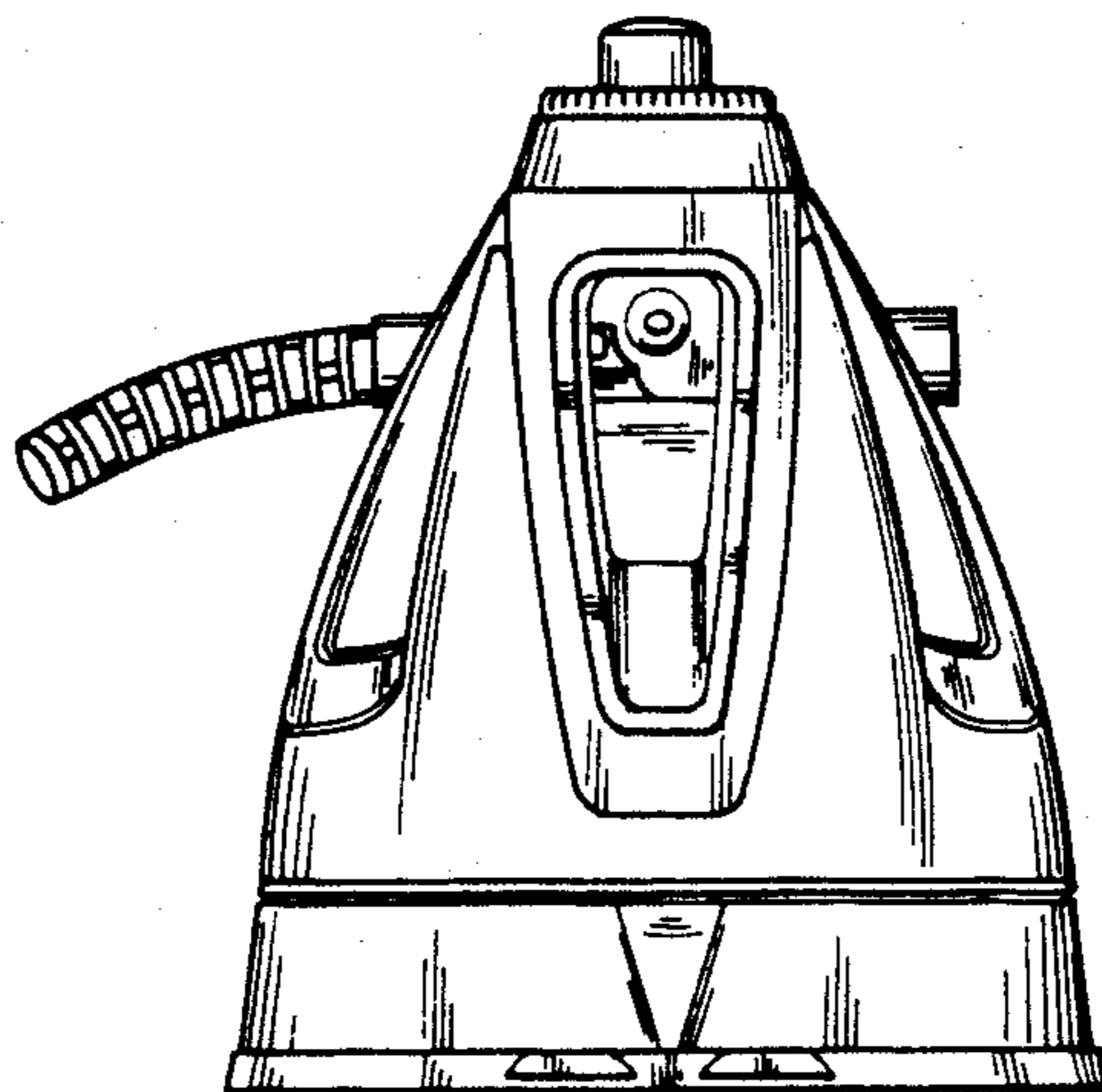

FIG. 4

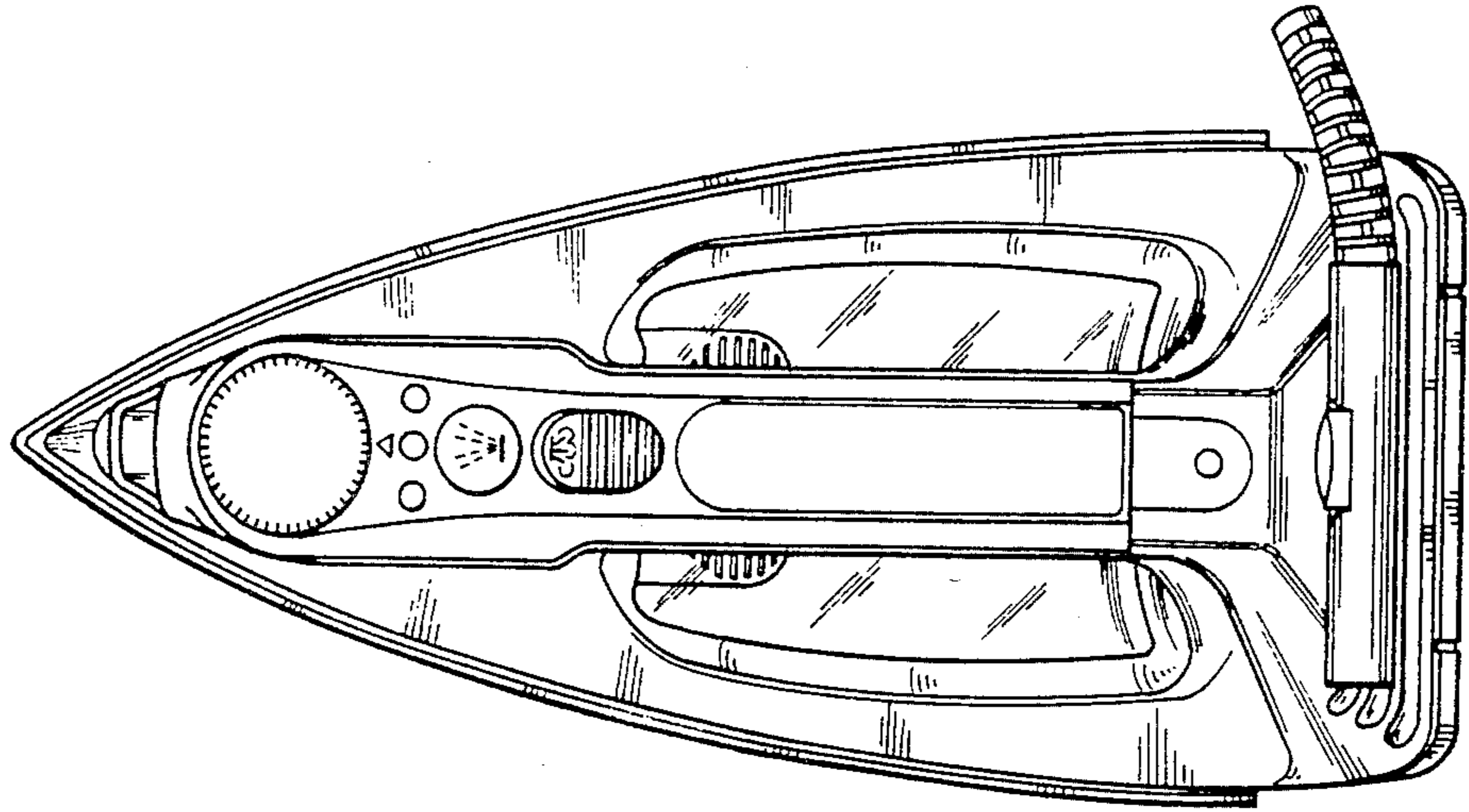

FIG. 5

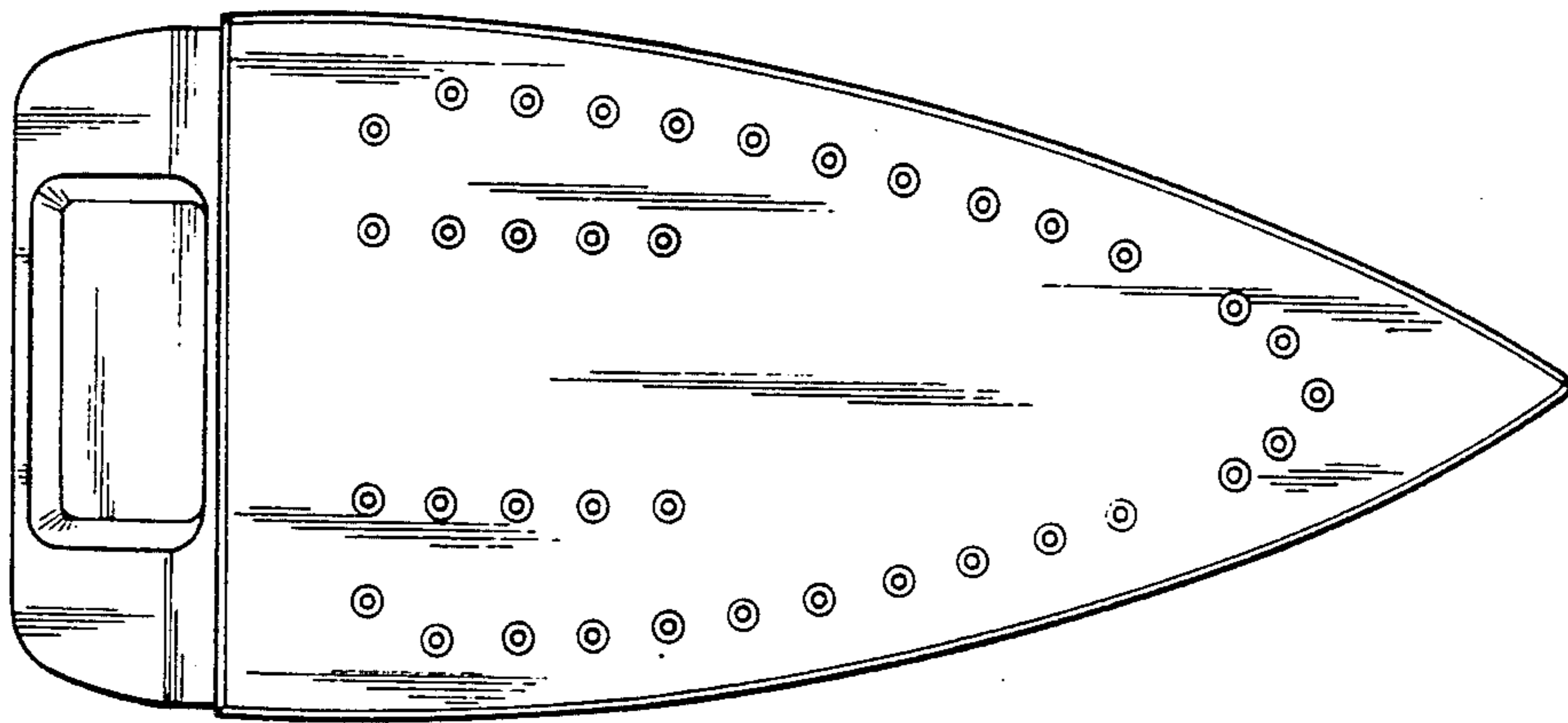

FIG. 6

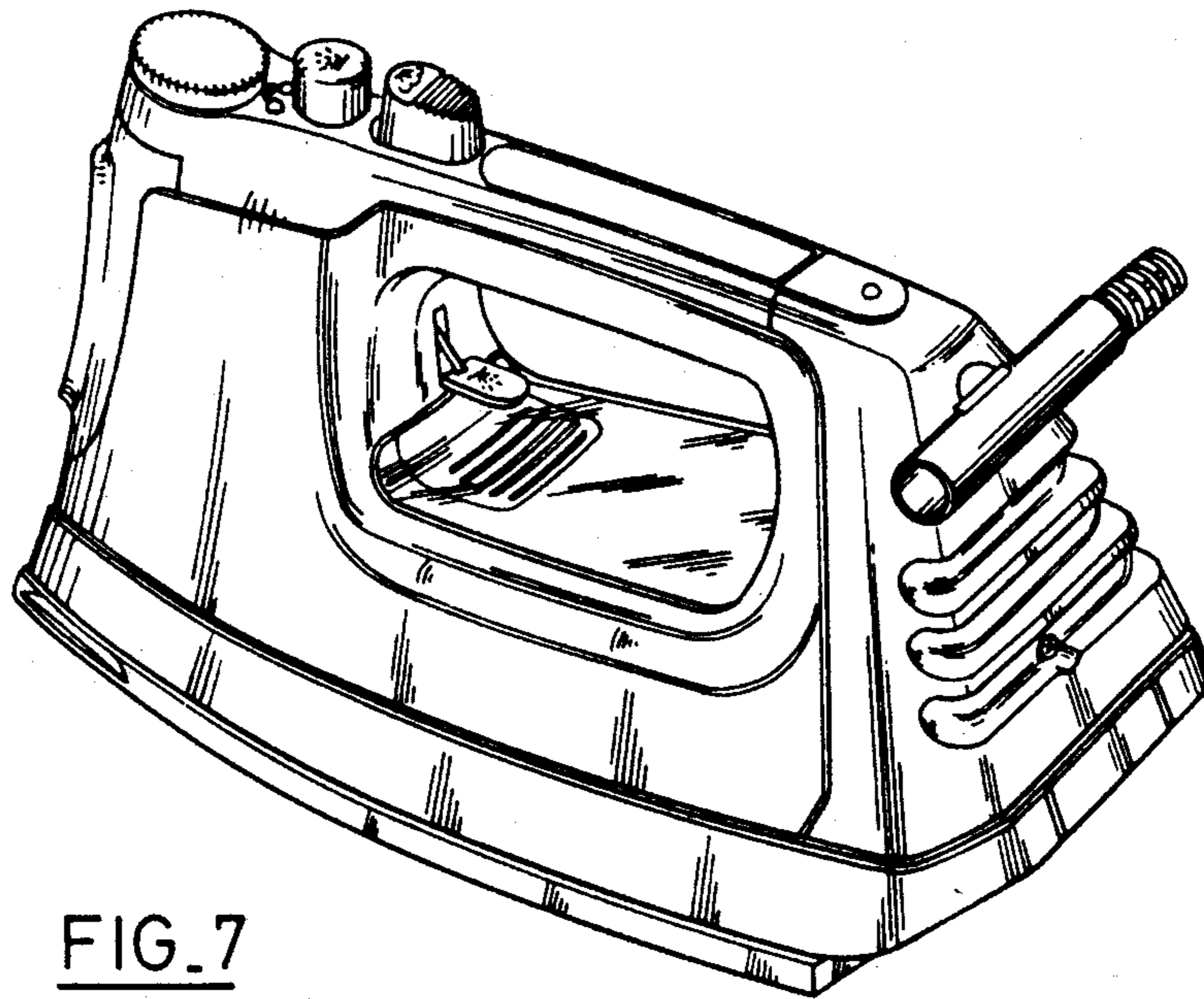

FIG. 7

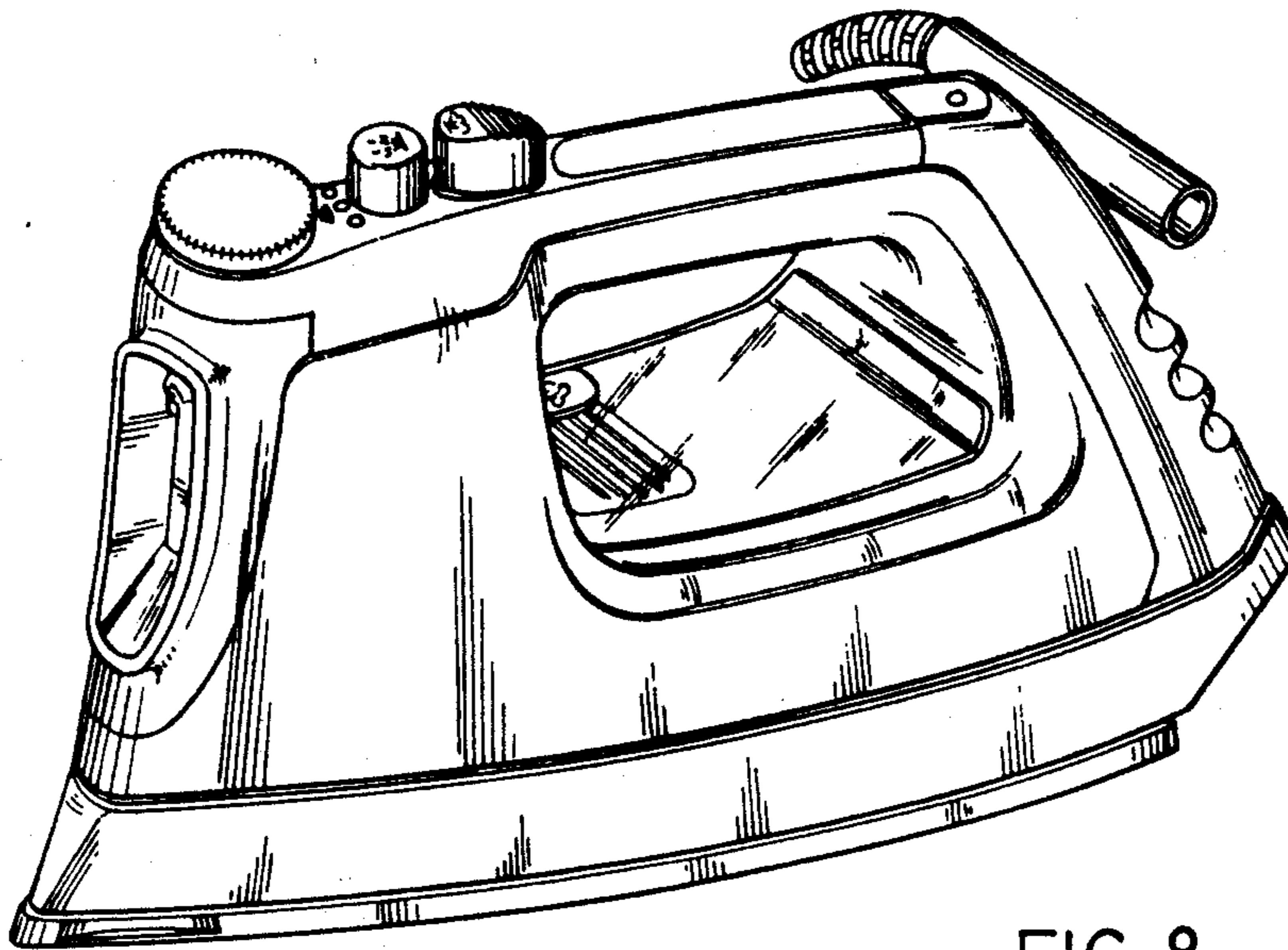

FIG. 8