

[54] TOILETRY CASE

[76] Inventor: Stephen J. Townley, 2190 Como Ave., St. Paul, Minn. 55108

[\*\*] Term: 14 Years

[21] Appl. No.: 675,086

[22] Filed: Nov. 26, 1984

[52] U.S. Cl. .... D3/39; D3/35

[58] Field of Search ..... D6/524, 525; D3/30.1, D3/35, 39; 132/79 R; 206/425, 444, 581

[56] References Cited

U.S. PATENT DOCUMENTS

D. 219,152	11/1970	Wooters .	
D. 219,549	12/1970	Wooters .	
D. 232,991	10/1974	Dilyard .	
D. 252,960	9/1979	Faust .....	D3/39
D. 281,463	11/1985	Rodrigues .....	D3/39
D. 282,410	2/1986	Ekuan .....	D3/30.1
1,638,638	8/1927	Lewis .....	D3/39
2,335,898	12/1943	Arnold .....	206/581
3,869,183	3/1975	Frank, Jr. ....	D6/525

Primary Examiner—B. J. Bullock  
Attorney, Agent, or Firm—Burd, Bartz & Gutenkauf

[57] CLAIM

The ornamental design for a toiletry case, substantially as shown and described.

DESCRIPTION

FIG. 1 is a perspective view of a toiletry case showing my new design, in the open position;  
 FIG. 2 is an enlarged front elevational view thereof;  
 FIG. 3 is an enlarged top plan view thereof;  
 FIG. 4 is an enlarged bottom plan view thereof;  
 FIG. 5 is an enlarged rear elevational view thereof;  
 FIG. 6 is an enlarged left side elevational view thereof, the side opposite being a mirror image;  
 FIG. 7 is a perspective view thereof, in the closed position;  
 FIG. 8 is a front elevational view of FIG. 7;  
 FIG. 9 is a rear elevational view of FIG. 7;  
 FIG. 10 is a left side elevational view of FIG. 7, the side opposite being a mirror image;  
 FIG. 11 is a top plan view of FIG. 7;  
 FIG. 12 is a bottom plan view of FIG. 7.

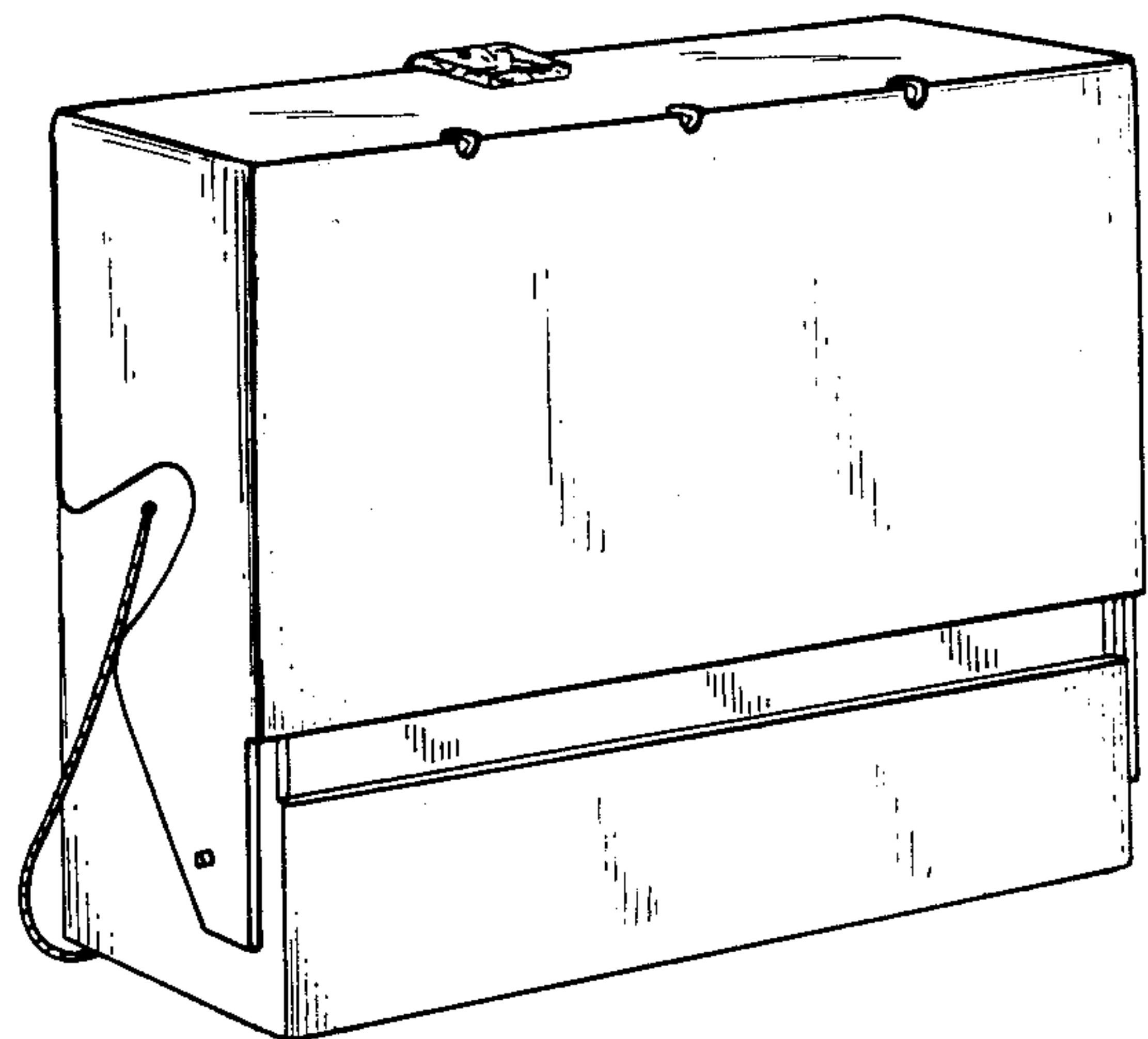
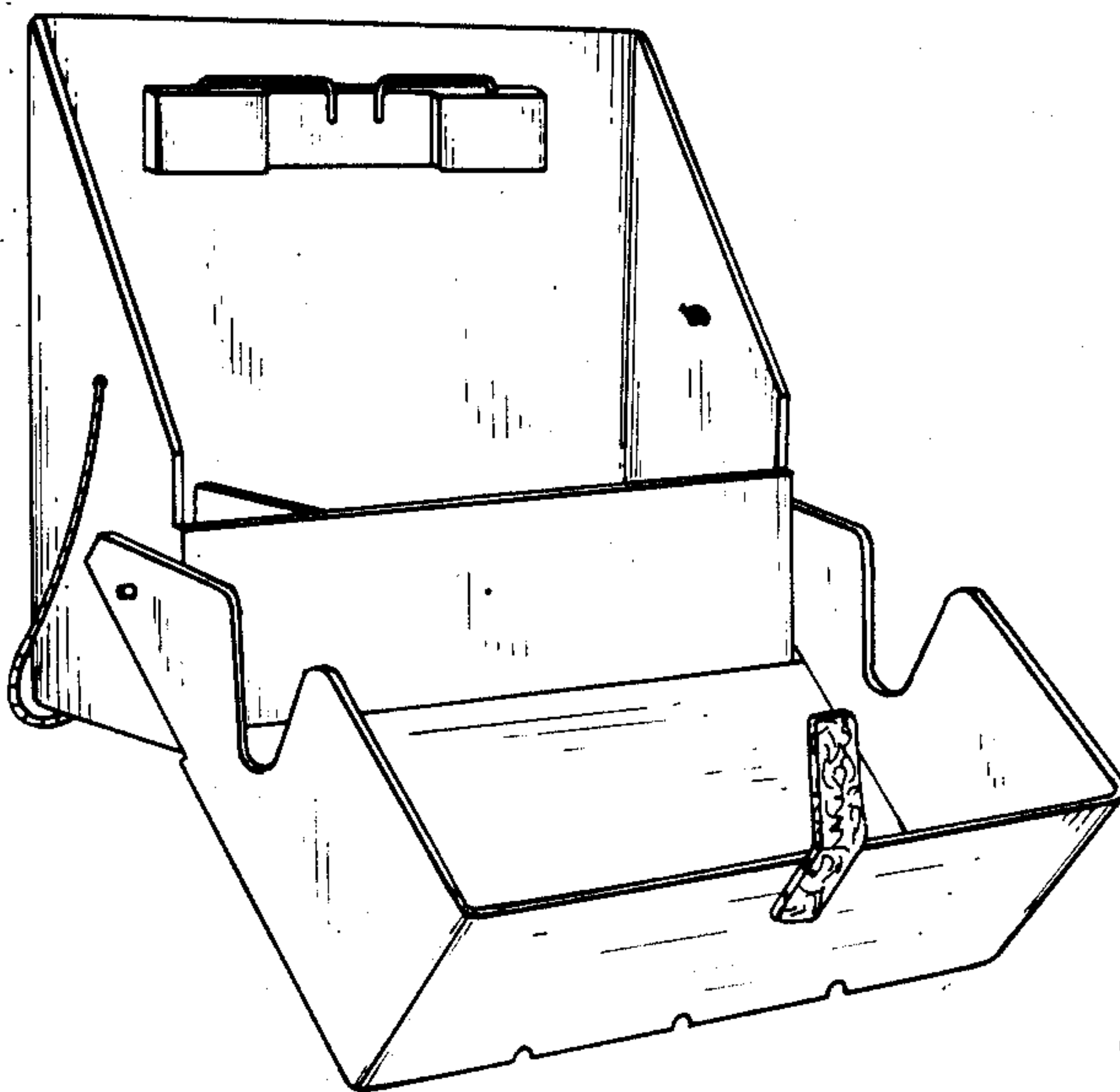

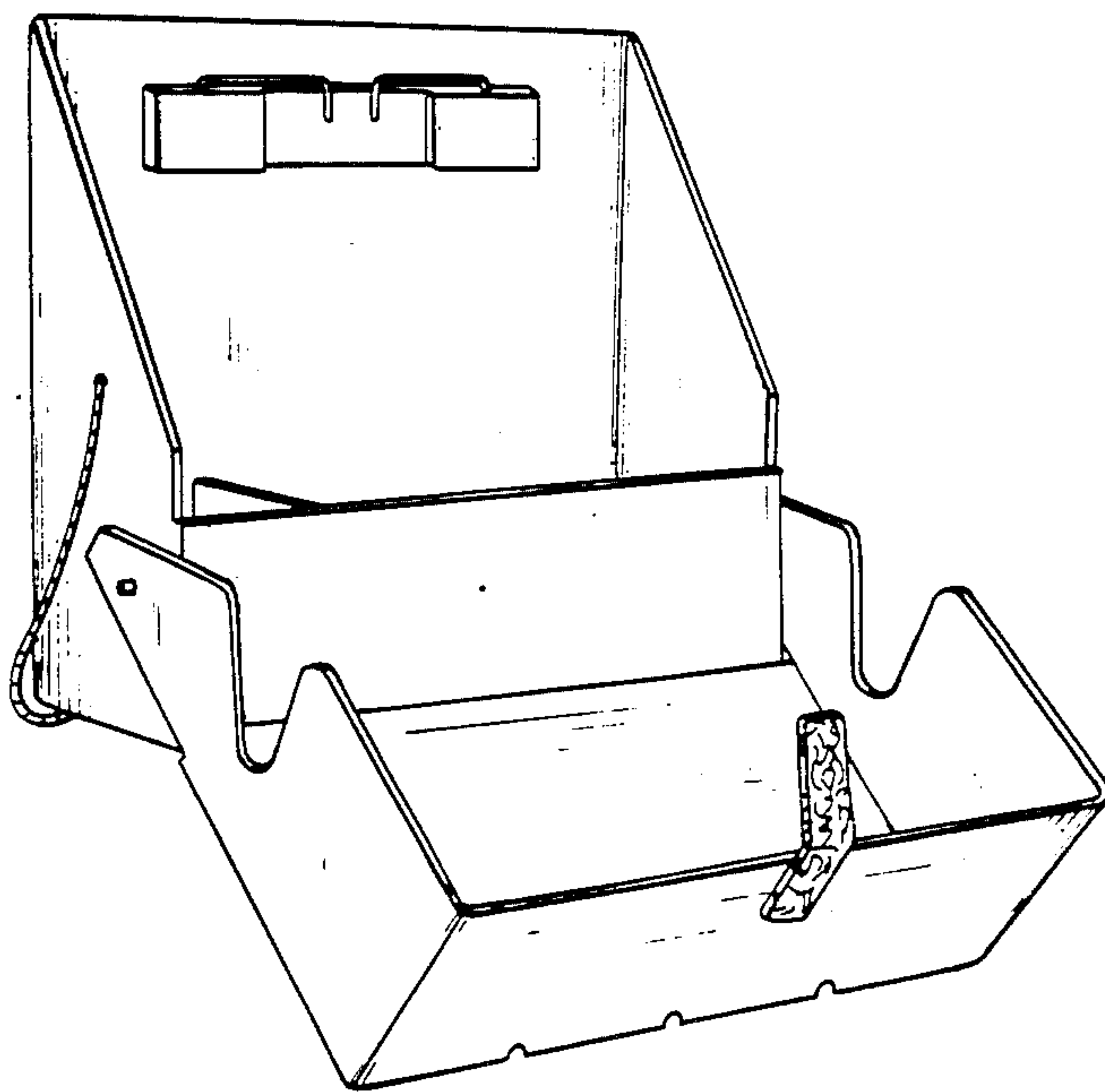

FIG. 1

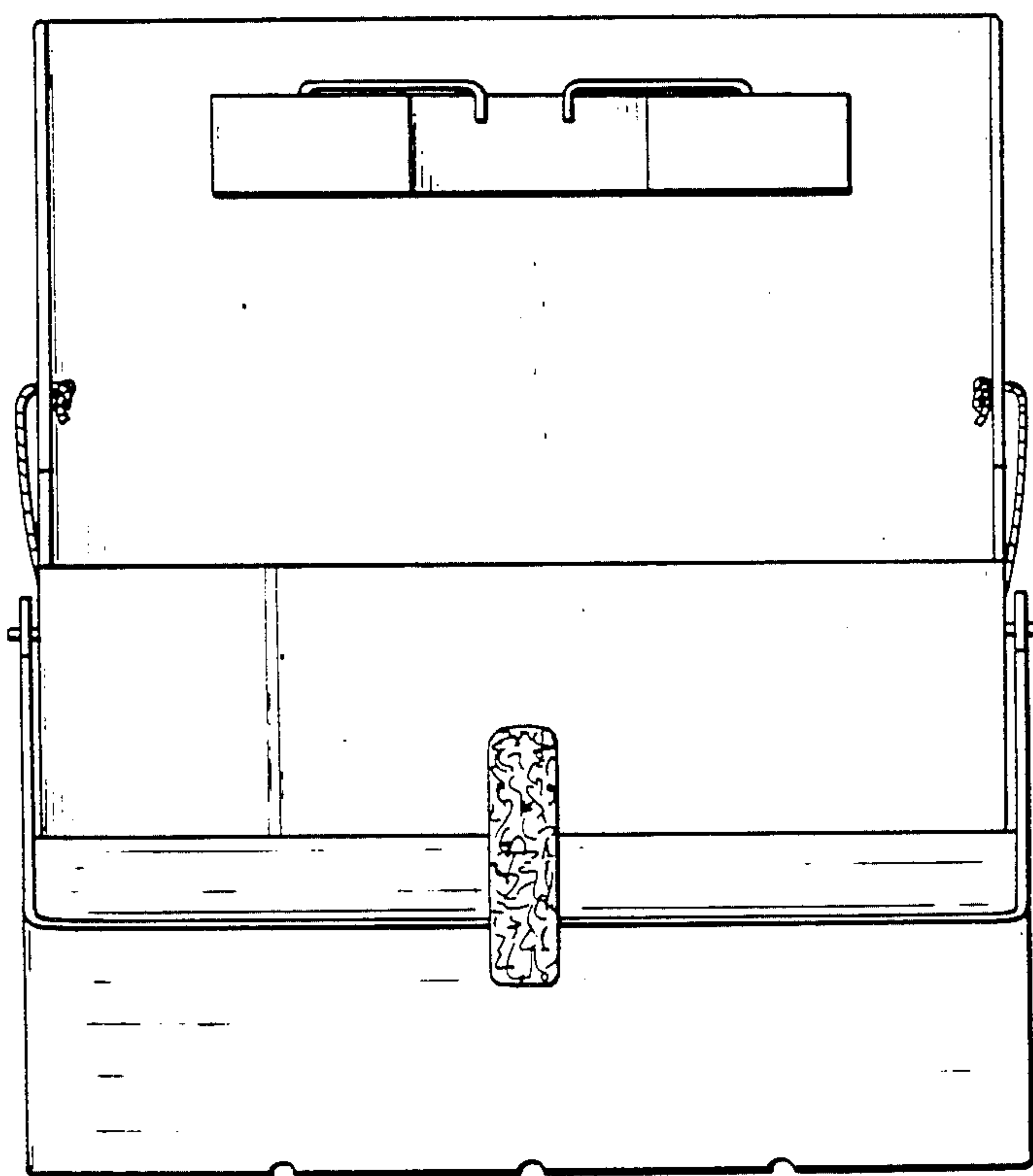

FIG. 2

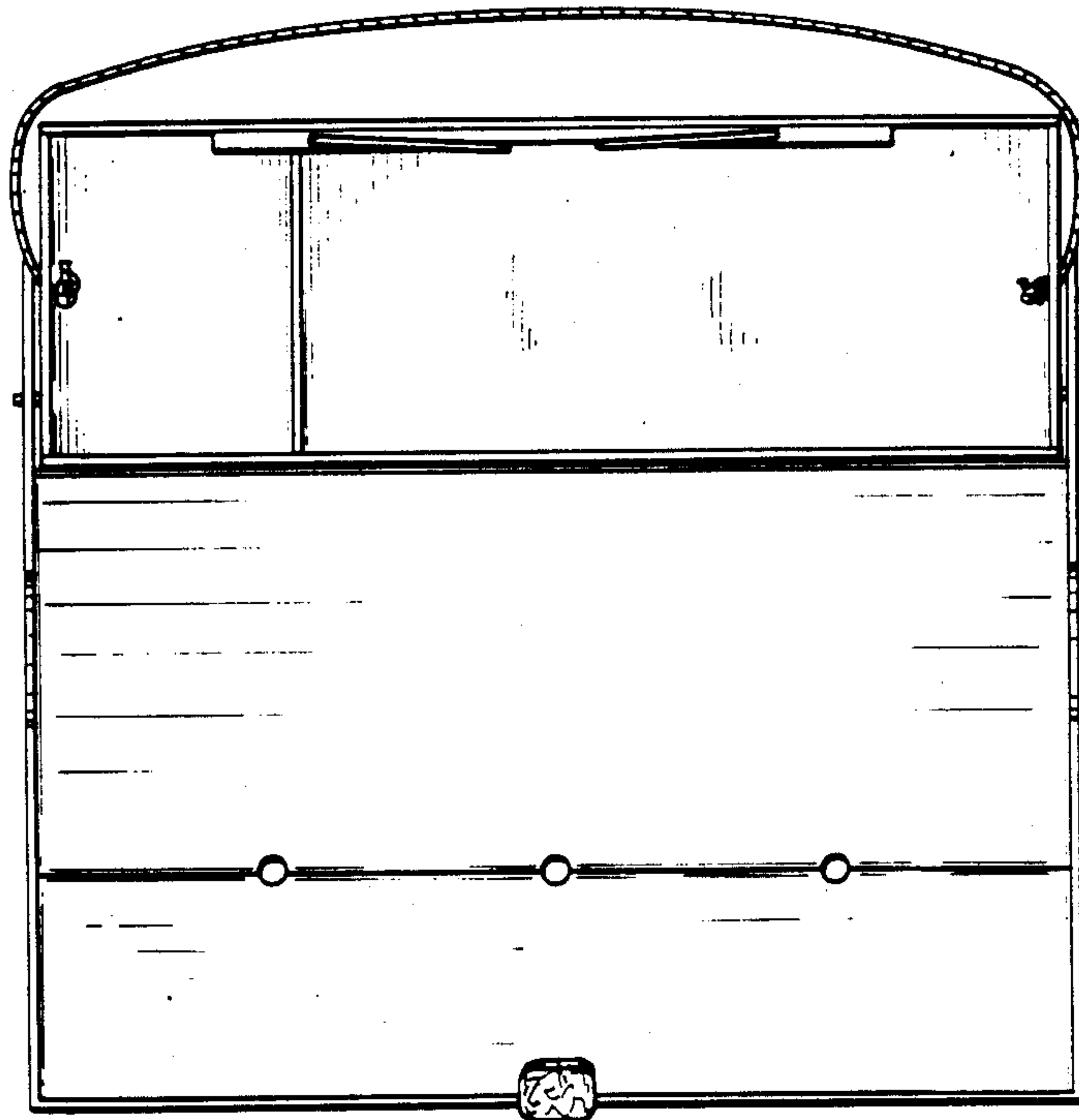

FIG. 3

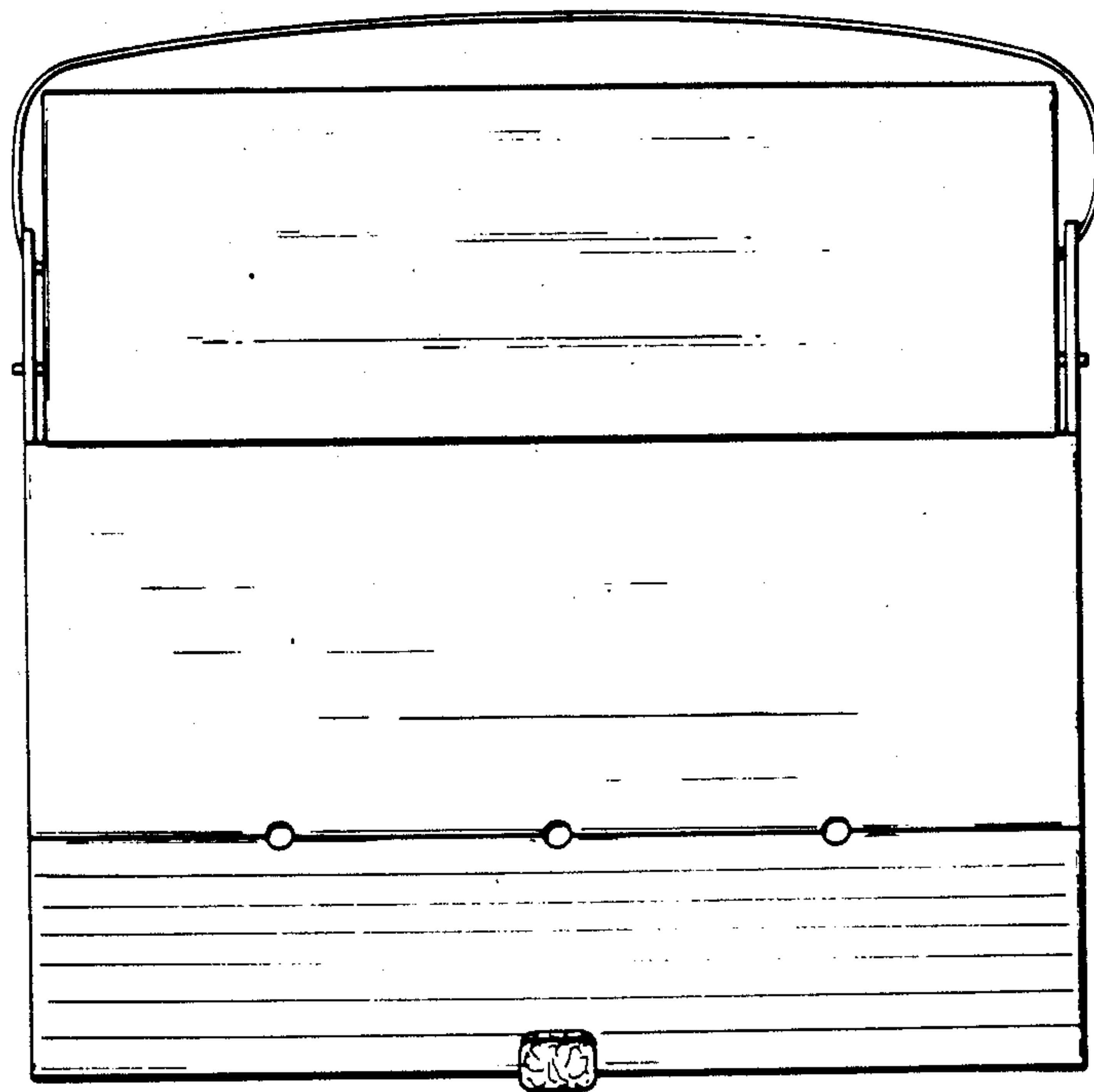

FIG. 4

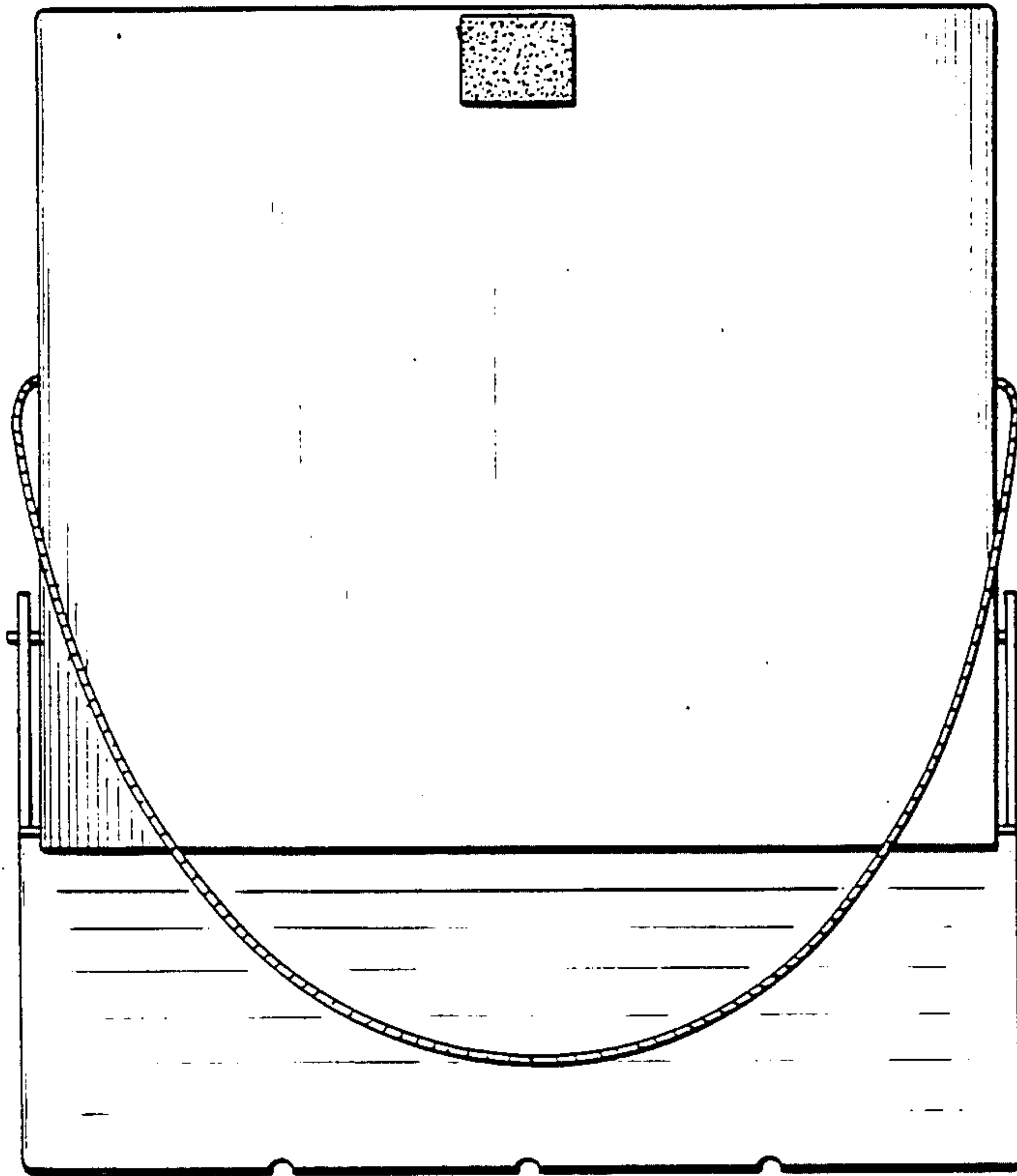

FIG. 5

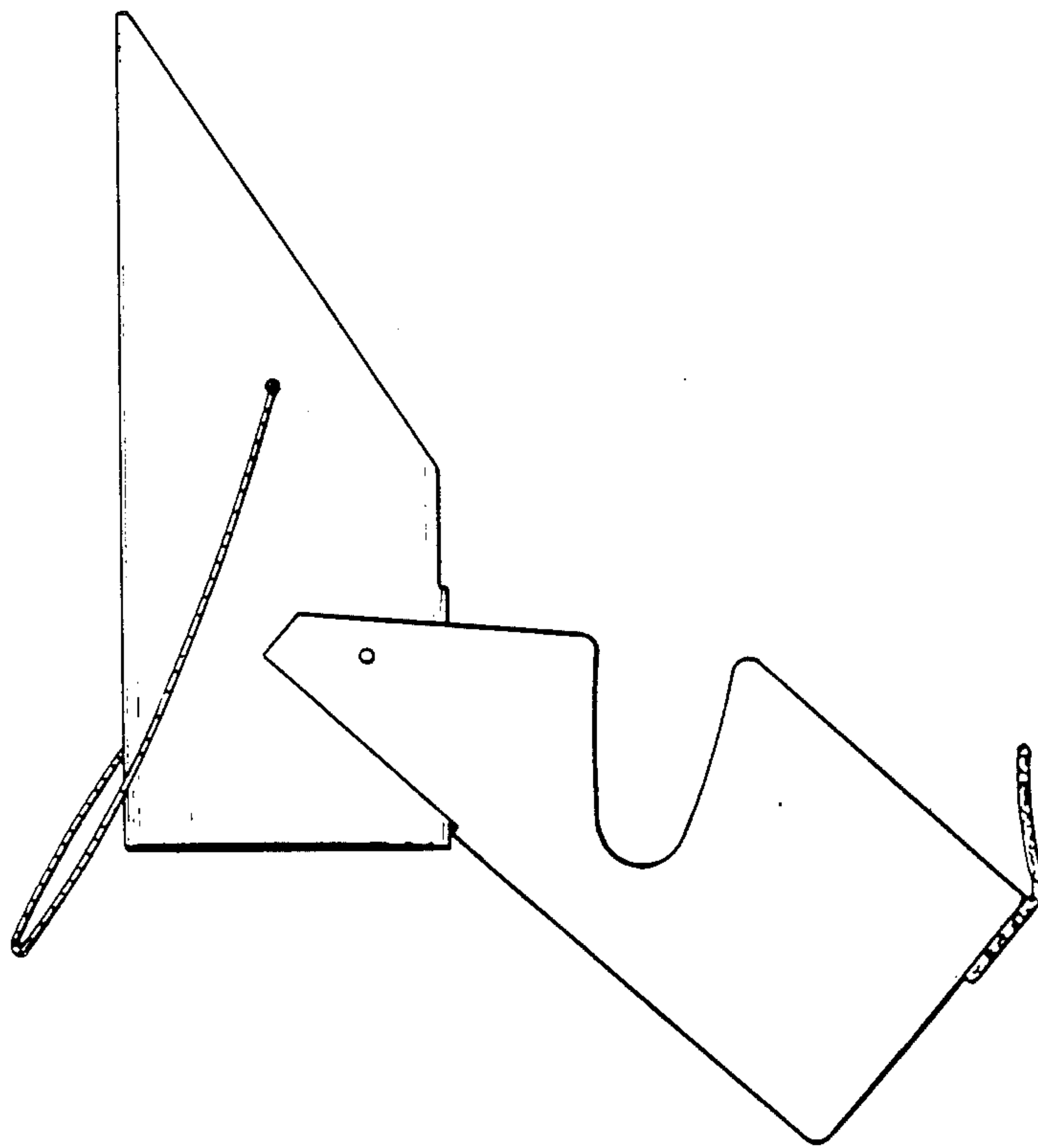

FIG. 6

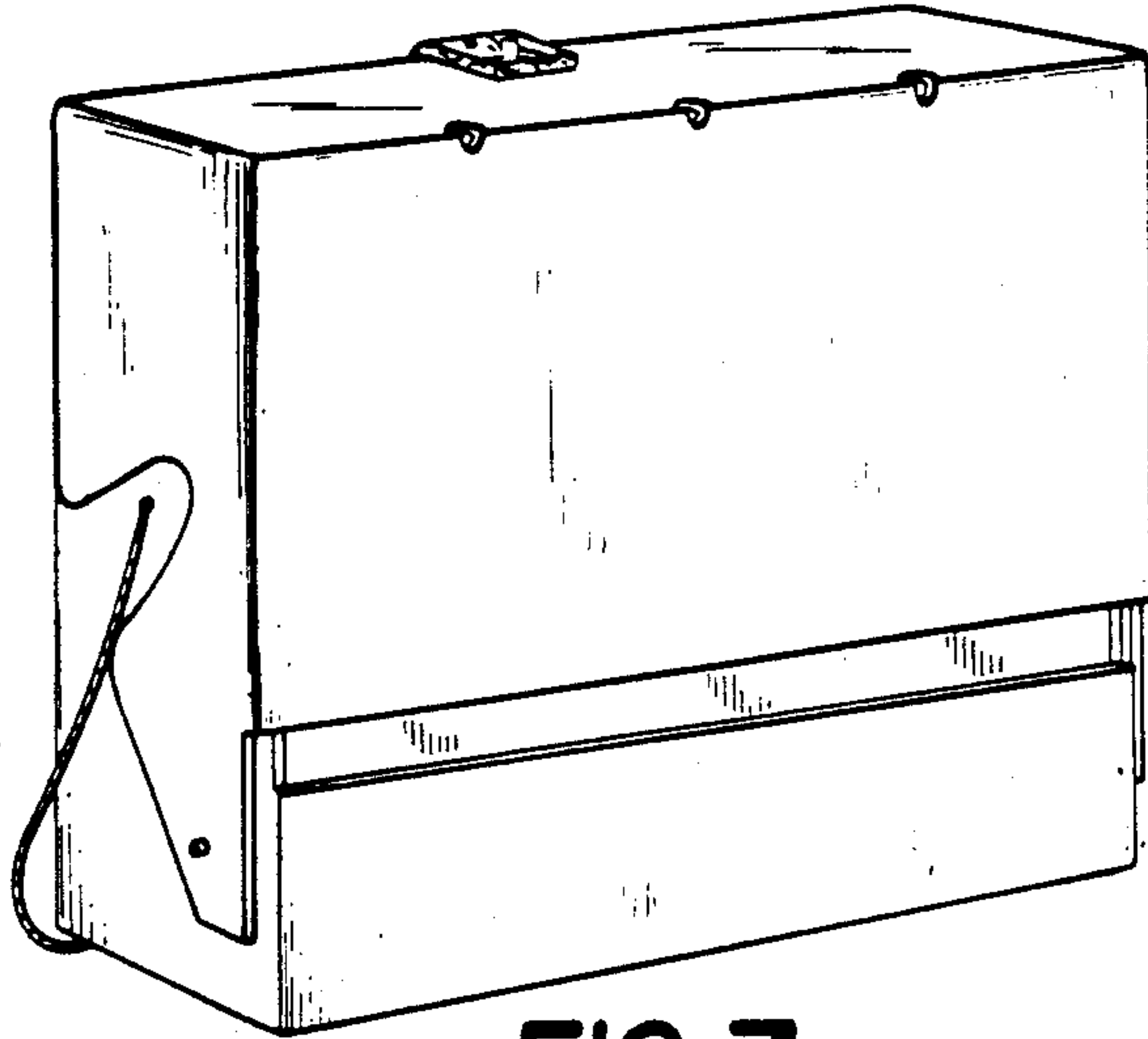

FIG. 7

FIG. 8

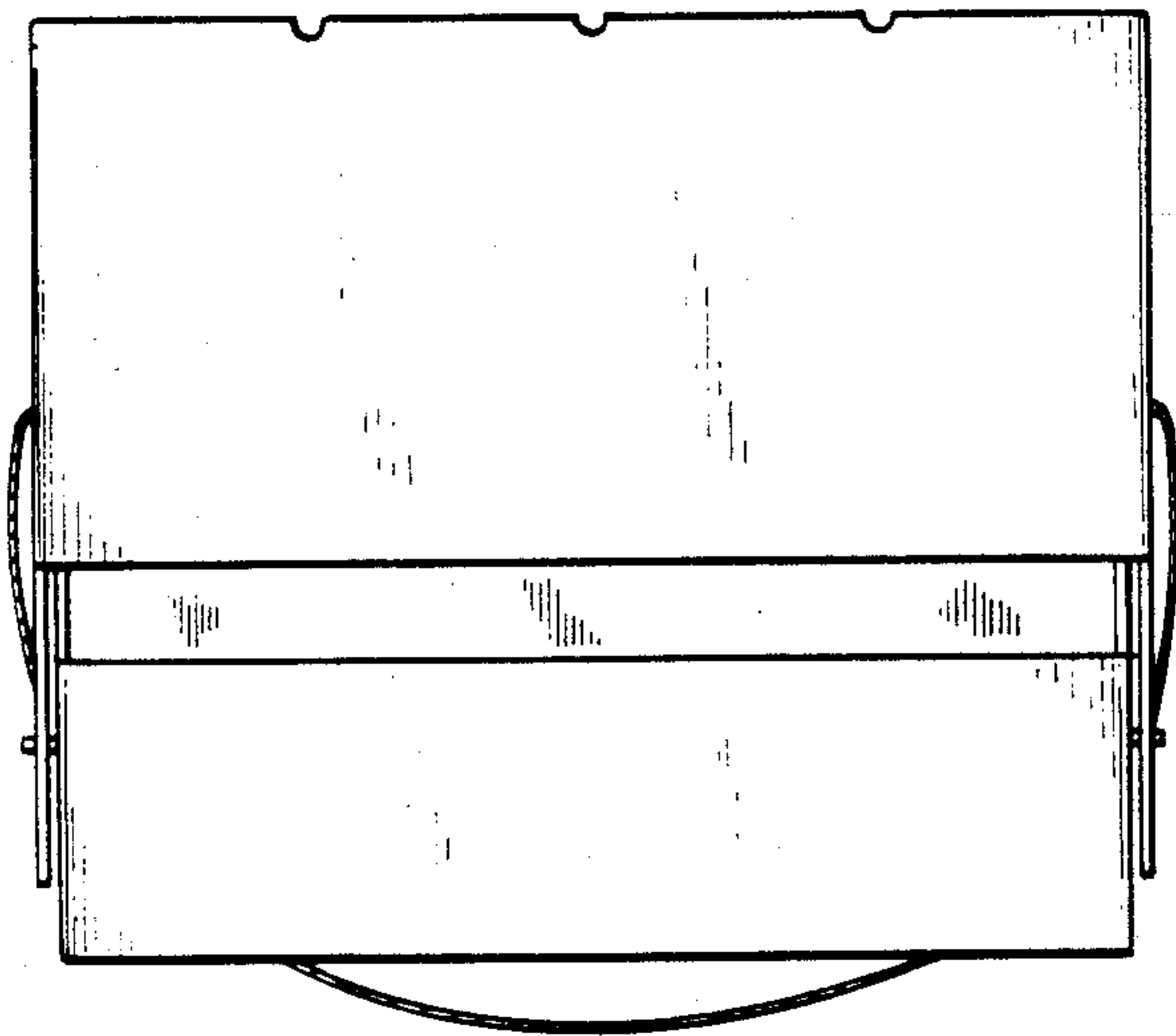

FIG. 9

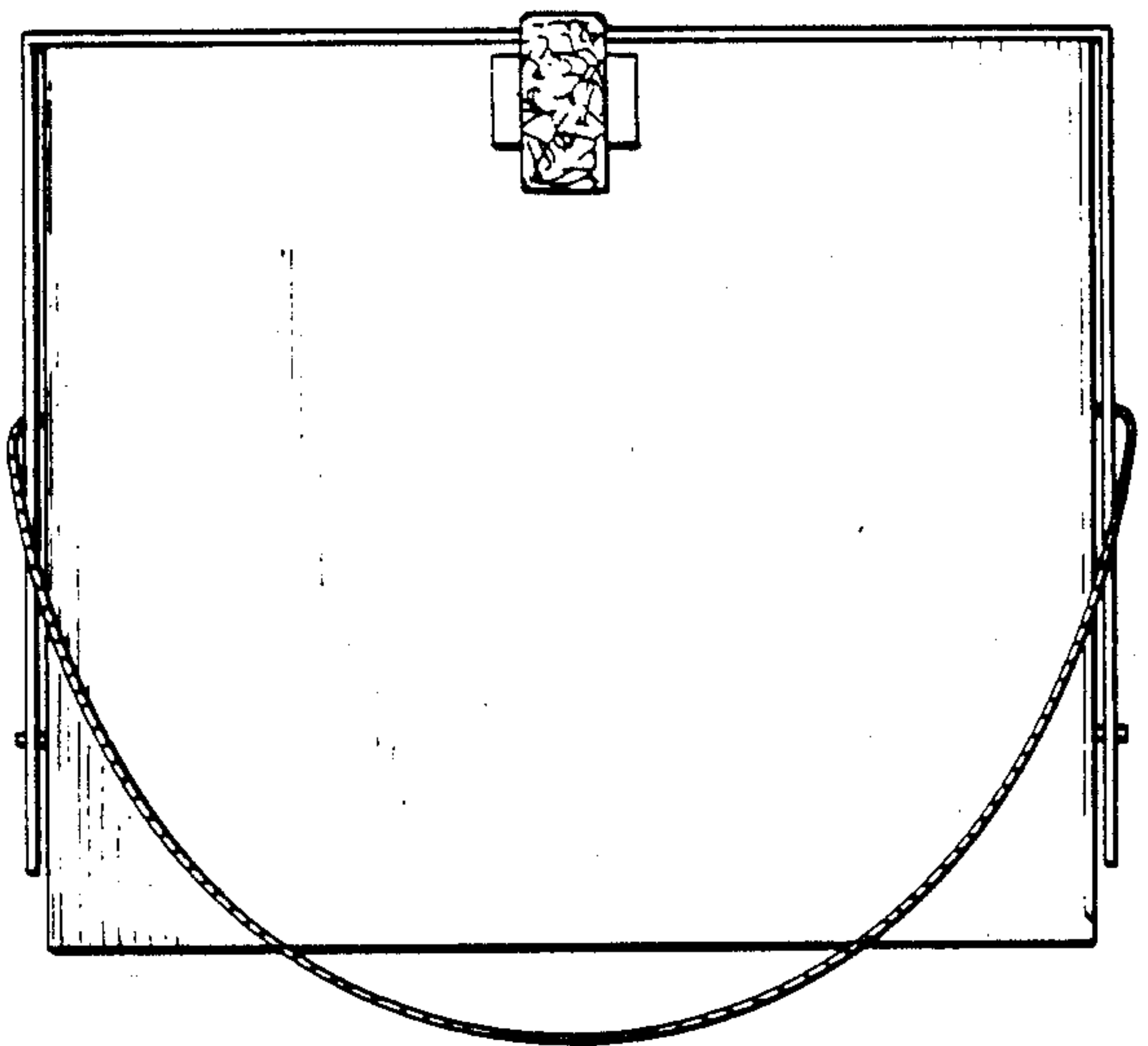

FIG. 10

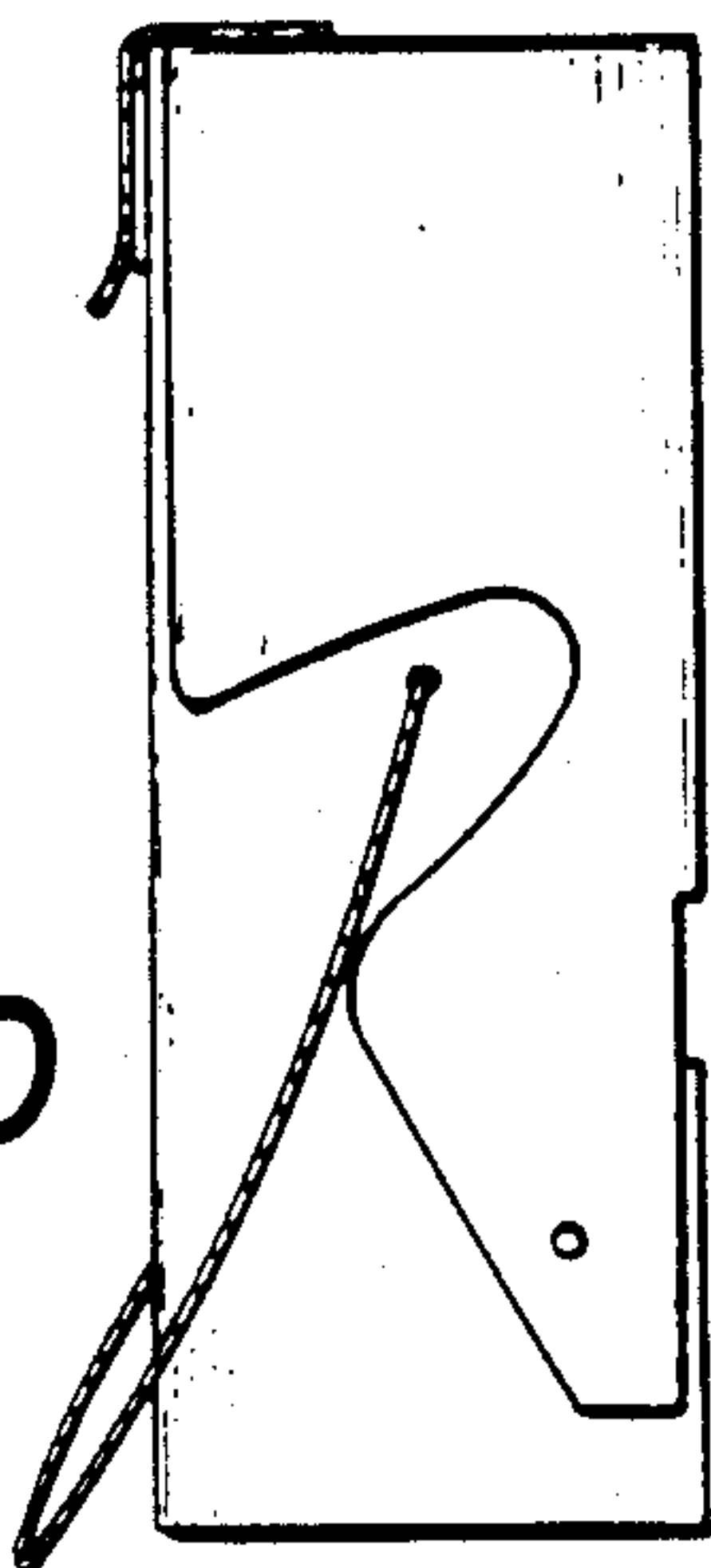

FIG. 11

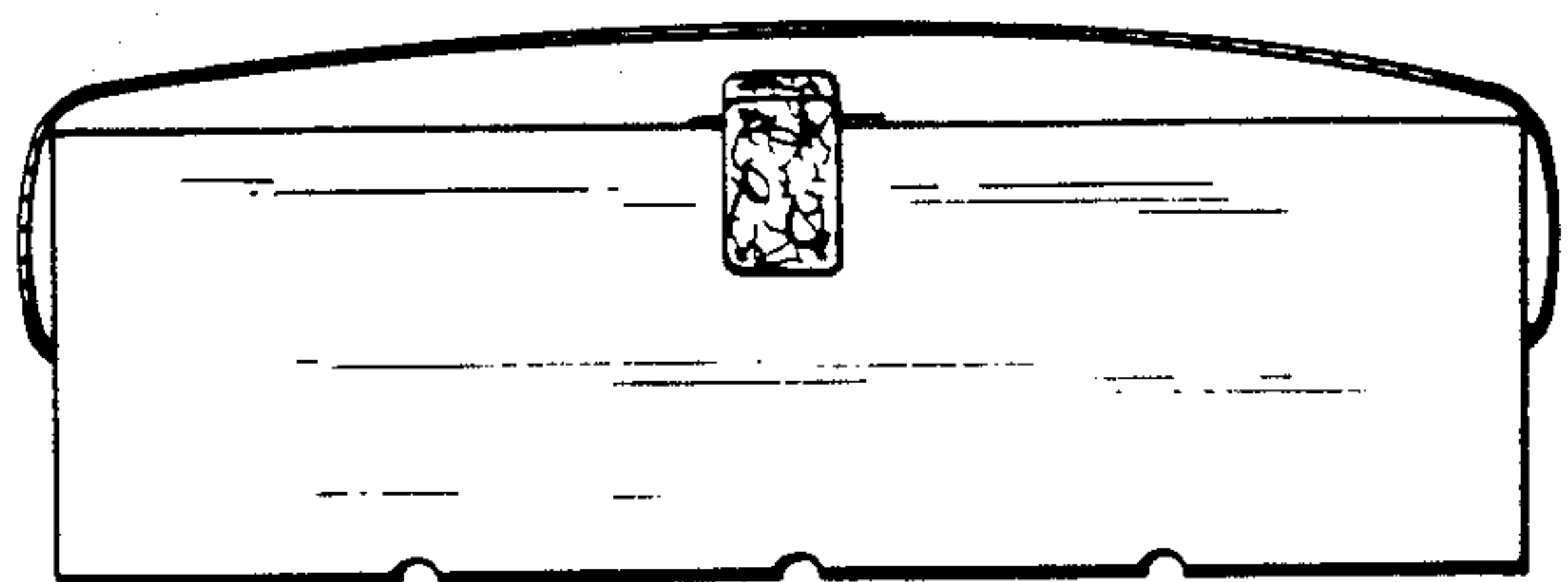

FIG. 12

