

[54] SEWING MACHINE

[75] Inventor: Koji Uchida, Hachioji, Japan

[73] Assignee: Janome Sewing Machine Co. Ltd., Tokyo, Japan

[*] Notice: The portion of the term of this patent subsequent to Jun. 9, 2001 has been disclaimed.

[**] Term: 14 Years

[21] Appl. No.: 584,093

[22] Filed: Feb. 27, 1984

[52] U.S. Cl. D15/69

[58] Field of Search D15/70, 69; 112/63, 112/258-261

[56] References Cited

U.S. PATENT DOCUMENTS

- D. 223,866 6/1972 Yamamoto D15/69
- D. 270,913 10/1983 Kosugi D15/69

- D. 274,435 6/1984 Hanyu et al. D15/69 X
- D. 276,344 11/1984 La Police et al. D15/69
- 3,066,627 12/1962 Schlosser et al. 112/260
- 4,220,103 9/1980 Kasahara et al. 112/260
- 4,314,517 2/1982 Kasahara 112/260
- 4,434,736 3/1984 Szostak et al. 112/258

Primary Examiner—Bernard Ansher
Assistant Examiner—Linda Titolo
Attorney, Agent, or Firm—Michael J. Striker

[57] CLAIM

The ornamental design for a sewing machine, substantially as shown and described.

DESCRIPTION

FIG. 1 is a front elevational view of a sewing machine showing my new design;
FIG. 2 is a rear elevational view thereof;
FIG. 3 is a left side elevational view thereof;
FIG. 4 is a right side elevational view thereof;
FIG. 5 is a top plan view thereof;
FIG. 6 is a bottom plan view thereof; and
FIG. 7 is a front perspective view thereof.

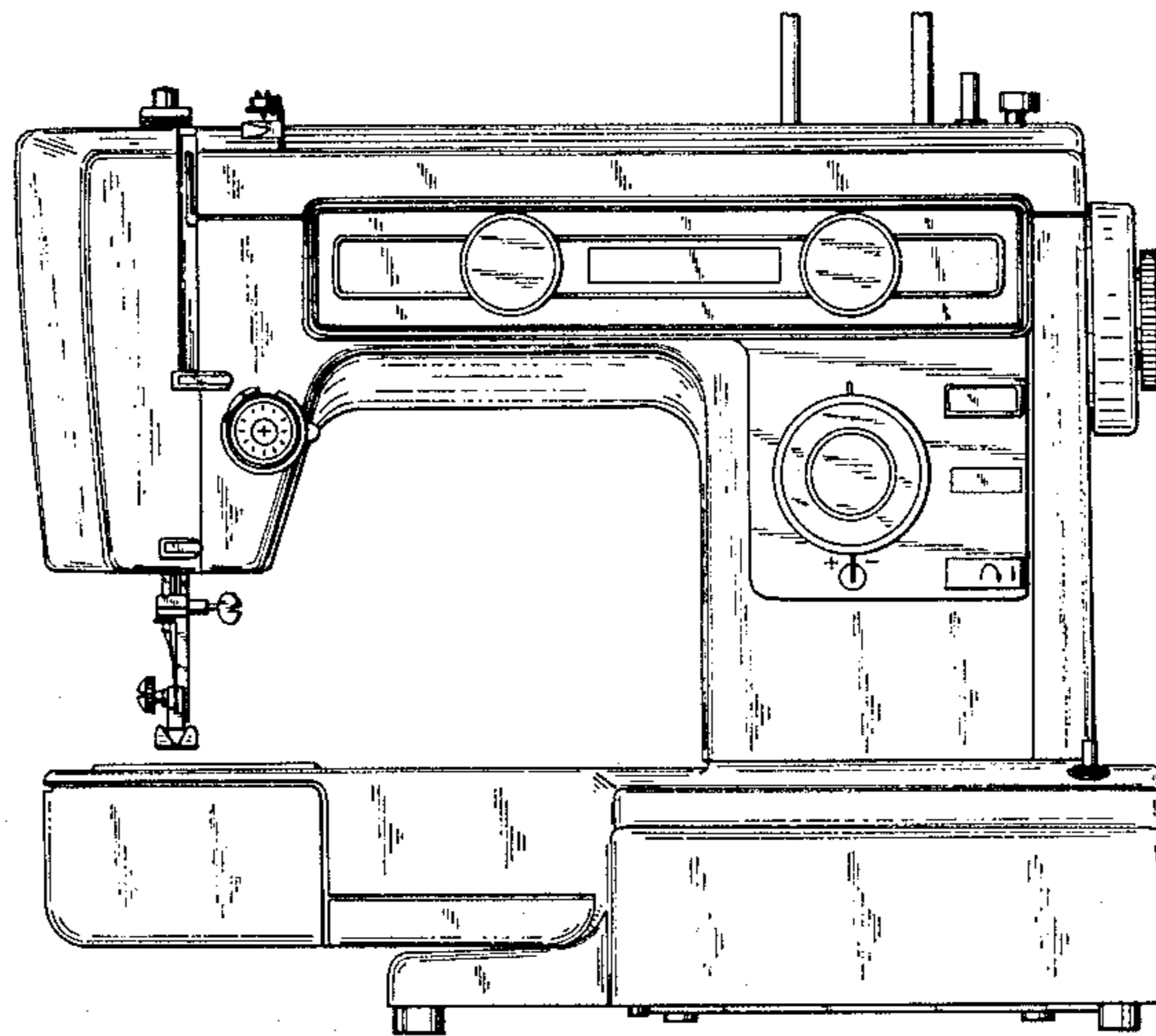

FIG. 1

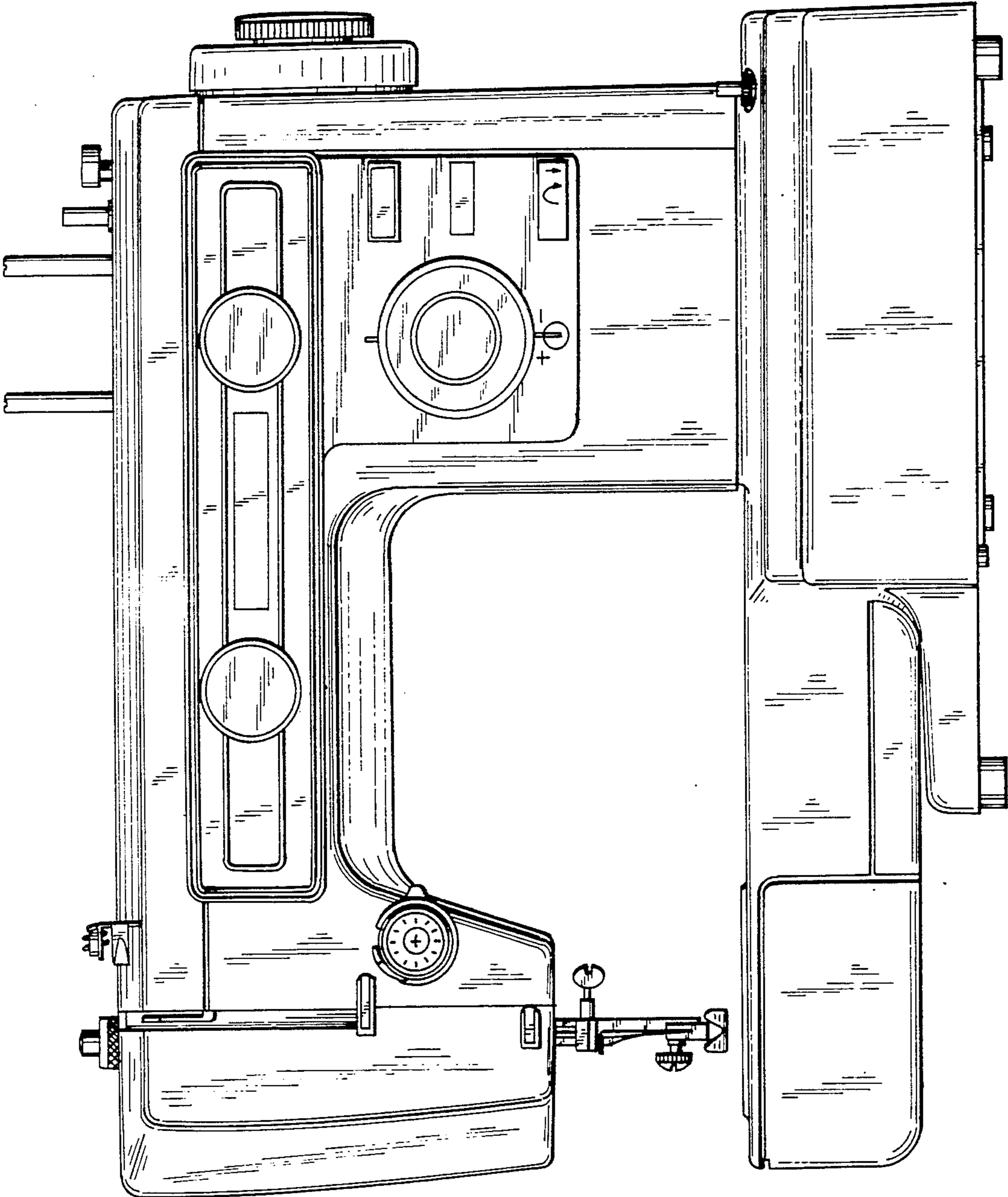

FIG. 2

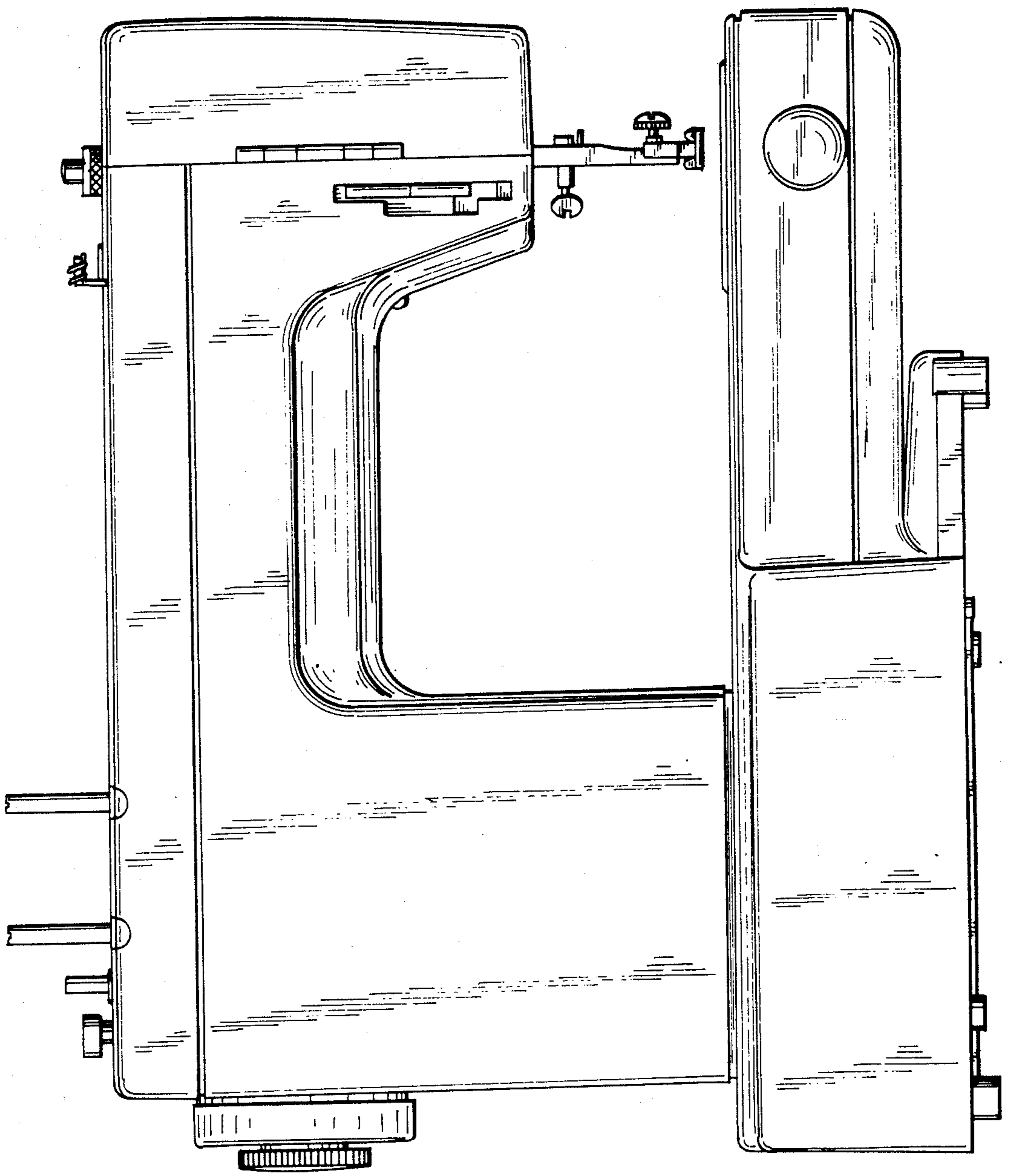

FIG. 3

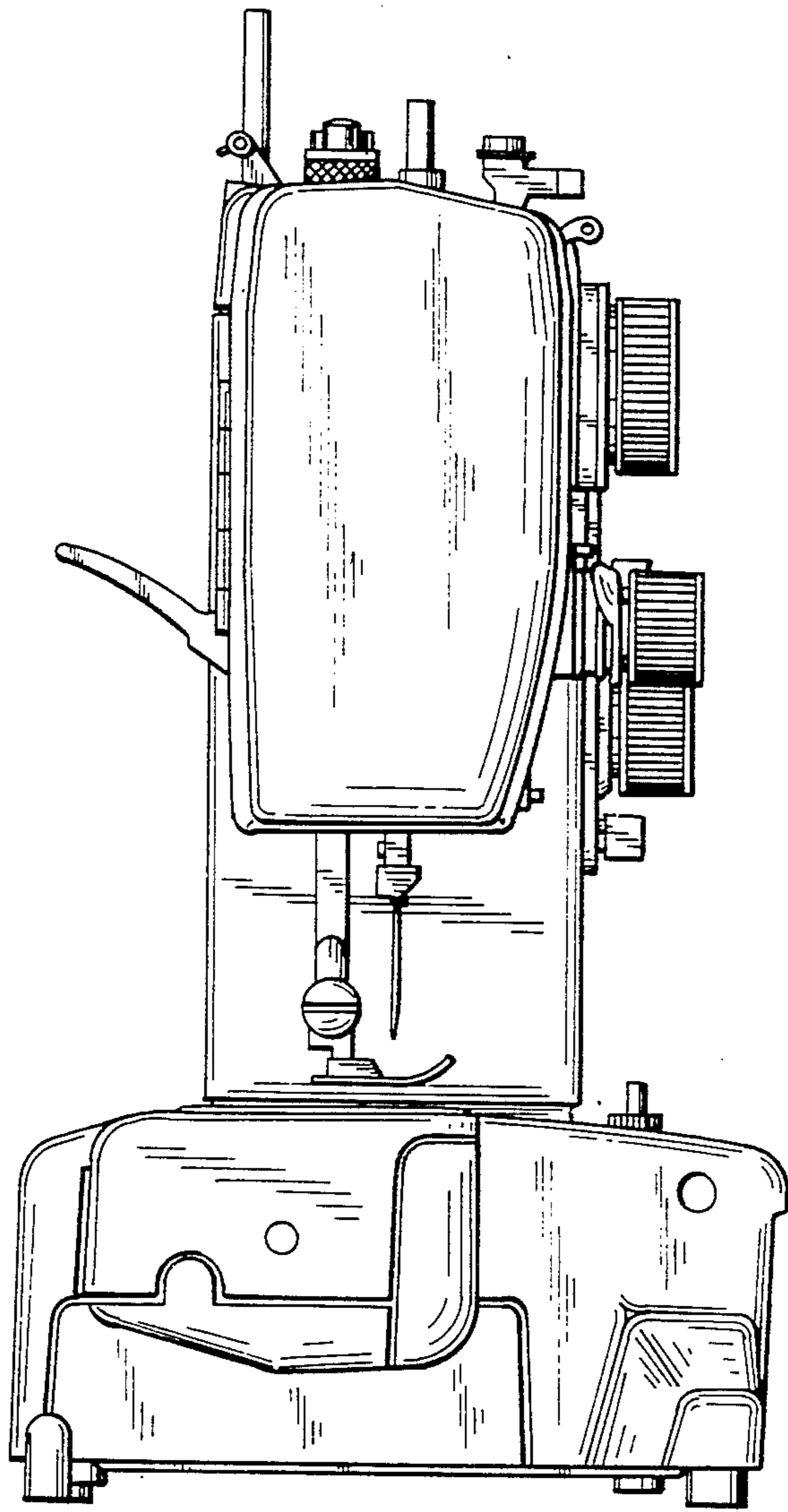

FIG. 4

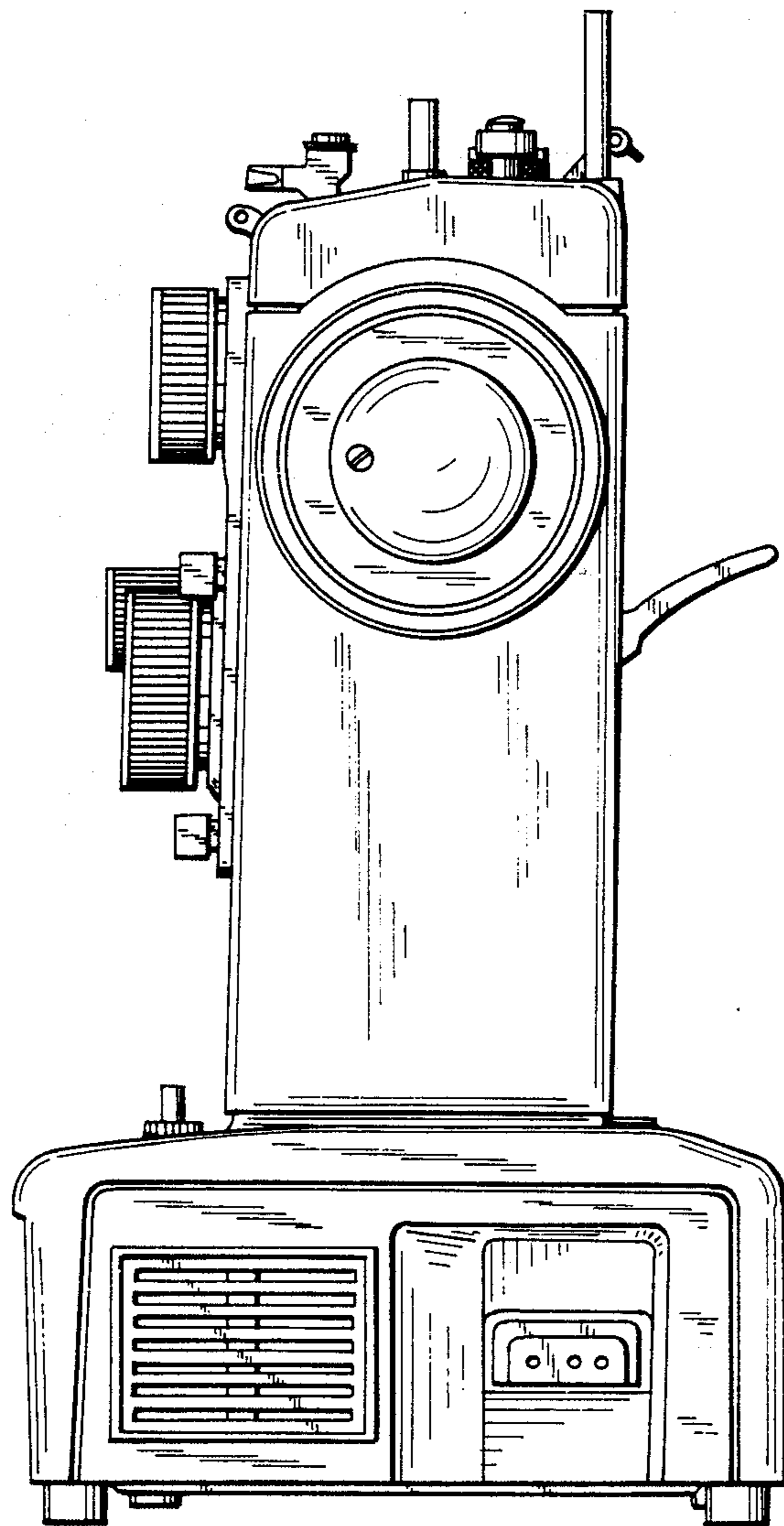

FIG. 5

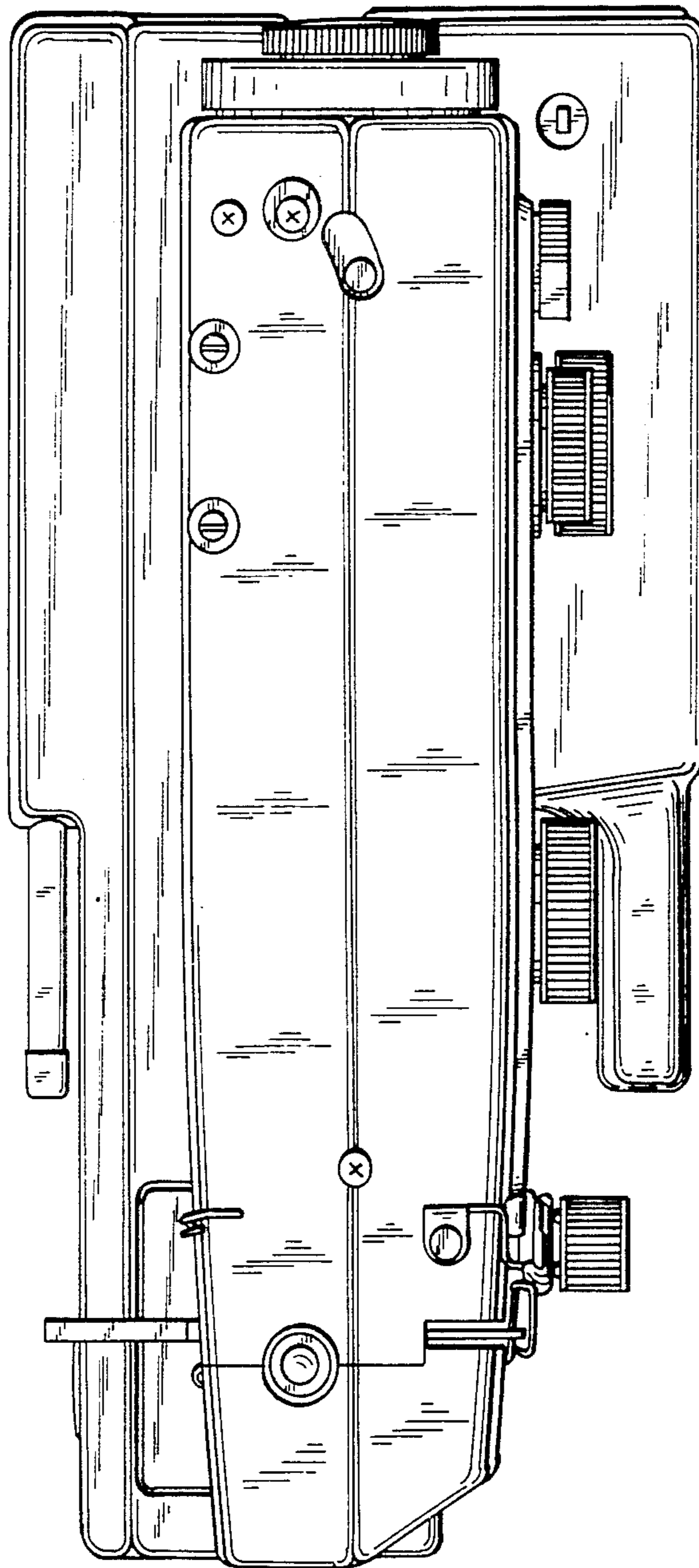
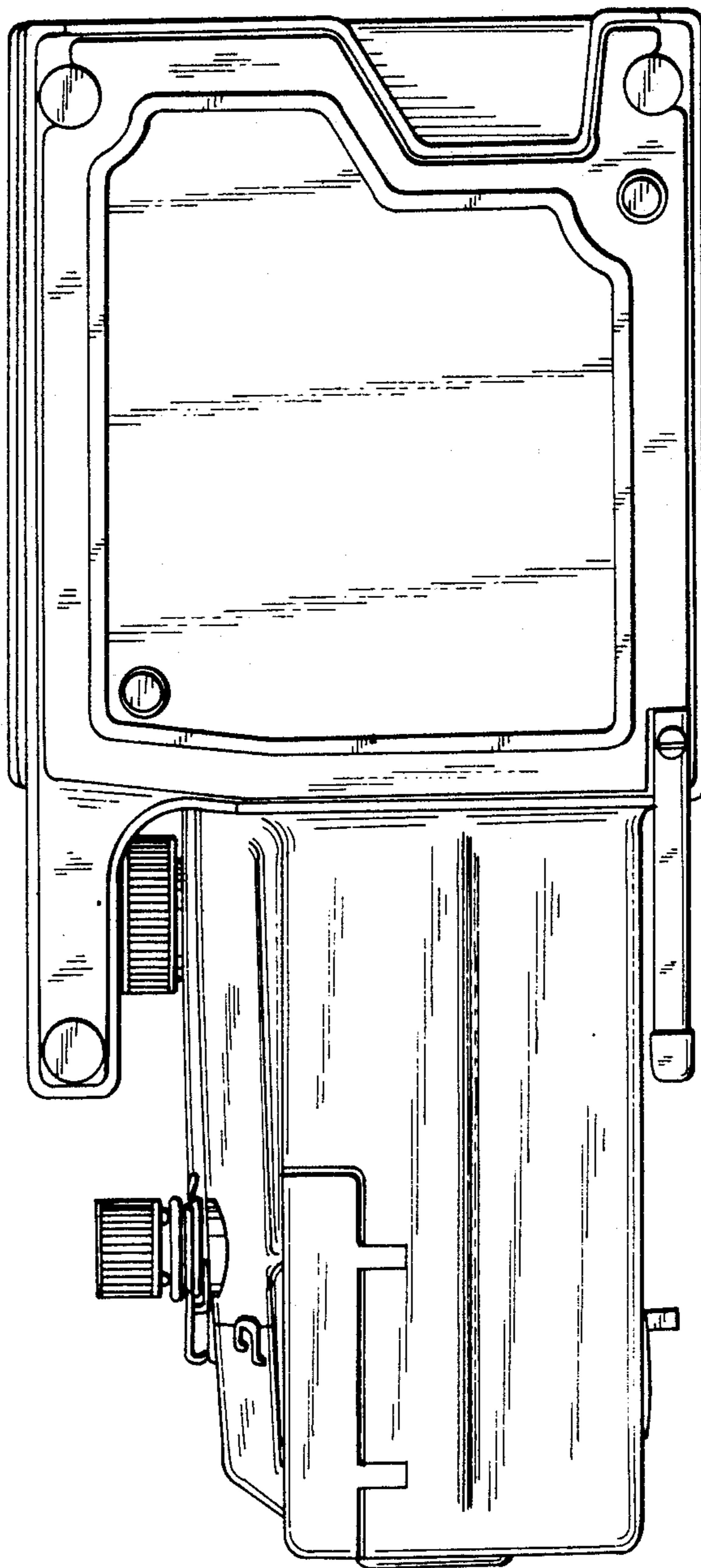

FIG. 6



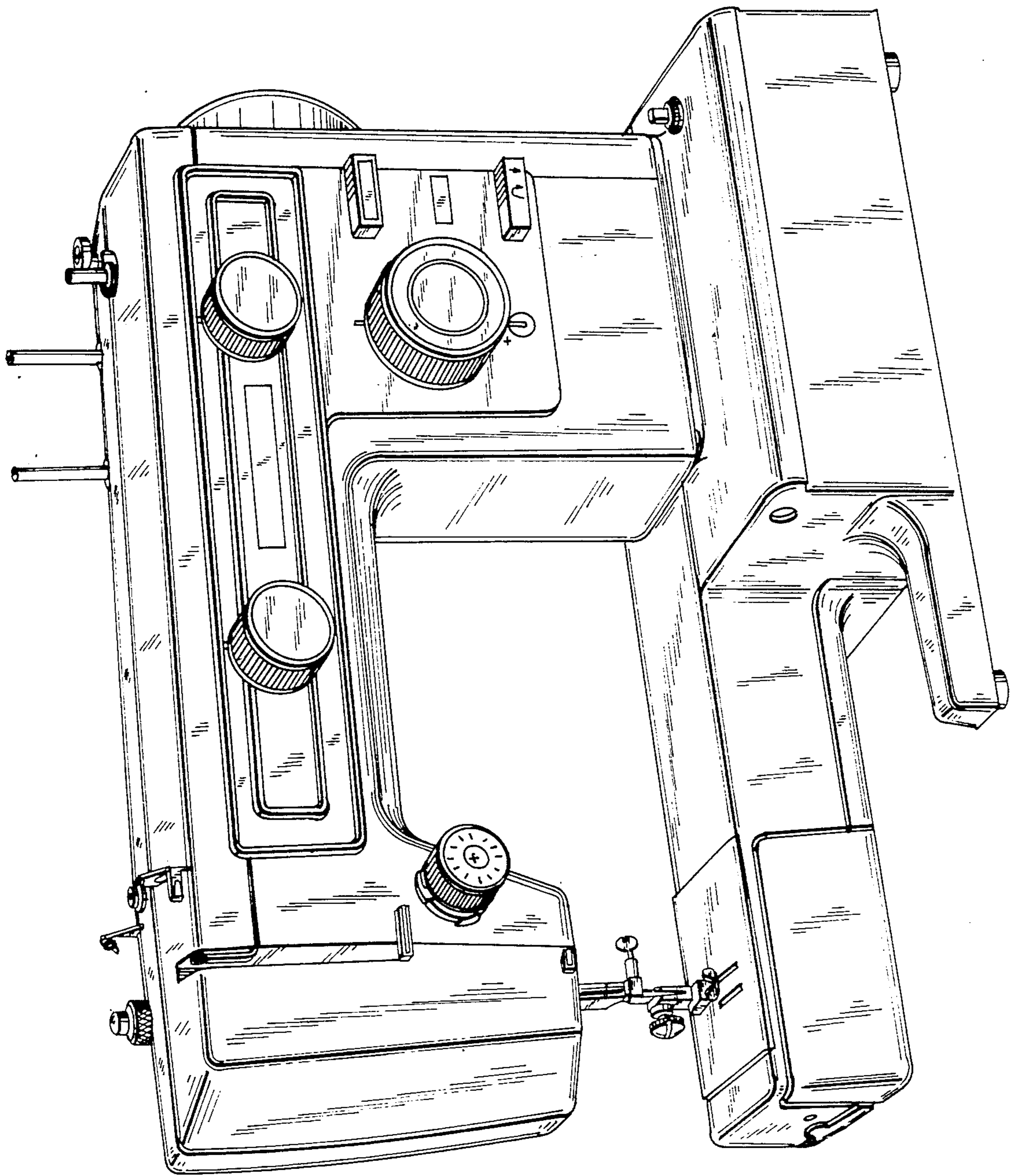

FIG. 7