

[54] ELECTRONIC TYPEWRITER

[75] Inventor: Toshio Yamamoto, Kanagawa, Japan

[73] Assignee: Ricoh Company, Ltd., Tokyo, Japan

[**] Term: 14 Years

[21] Appl. No.: 690,145

[22] Filed: Jan. 10, 1985

[30] Foreign Application Priority Data

Jul. 10, 1984 [JP]	Japan	59-028,579
Jul. 10, 1984 [JP]	Japan	59-028,580

[52] U.S. Cl. D18/1

[58] Field of Search D18/1, 2, 12;
400/689-694

[56] References Cited

U.S. PATENT DOCUMENTS

D. 257,771	1/1981	Dargatz	D18/1 X
D. 277,968	3/1985	Jolliffe	D18/1
D. 281,509	11/1985	Jolliffe	D18/1

Primary Examiner—Louis S. Zarfes

Attorney, Agent, or Firm—Oblon, Fisher, Spivak,
McClelland & Maier

[57] CLAIM

The ornamental design for an electronic typewriter, as shown and described.

DESCRIPTION

FIG. 1 is a top, front, right side perspective view of an electronic typewriter showing my new design;
 FIG. 2 is a front elevation thereof;
 FIG. 3 is a top plan view thereof;
 FIG. 4 is a right side elevation thereof;
 FIG. 5 is a left side elevation thereof;
 FIG. 6 is a rear elevation thereof;
 FIG. 7 is a bottom plan view thereof;
 FIG. 8 is a top, front, right side perspective view of an electronic typewriter showing a modified form of my new design;
 FIG. 9 is a front elevation thereof;
 FIG. 10 is a top plan view thereof;
 FIG. 11 is a right side elevation thereof;
 FIG. 12 is a left side elevation thereof;
 FIG. 13 is a rear elevation thereof; and
 FIG. 14 is a bottom plan view thereof.

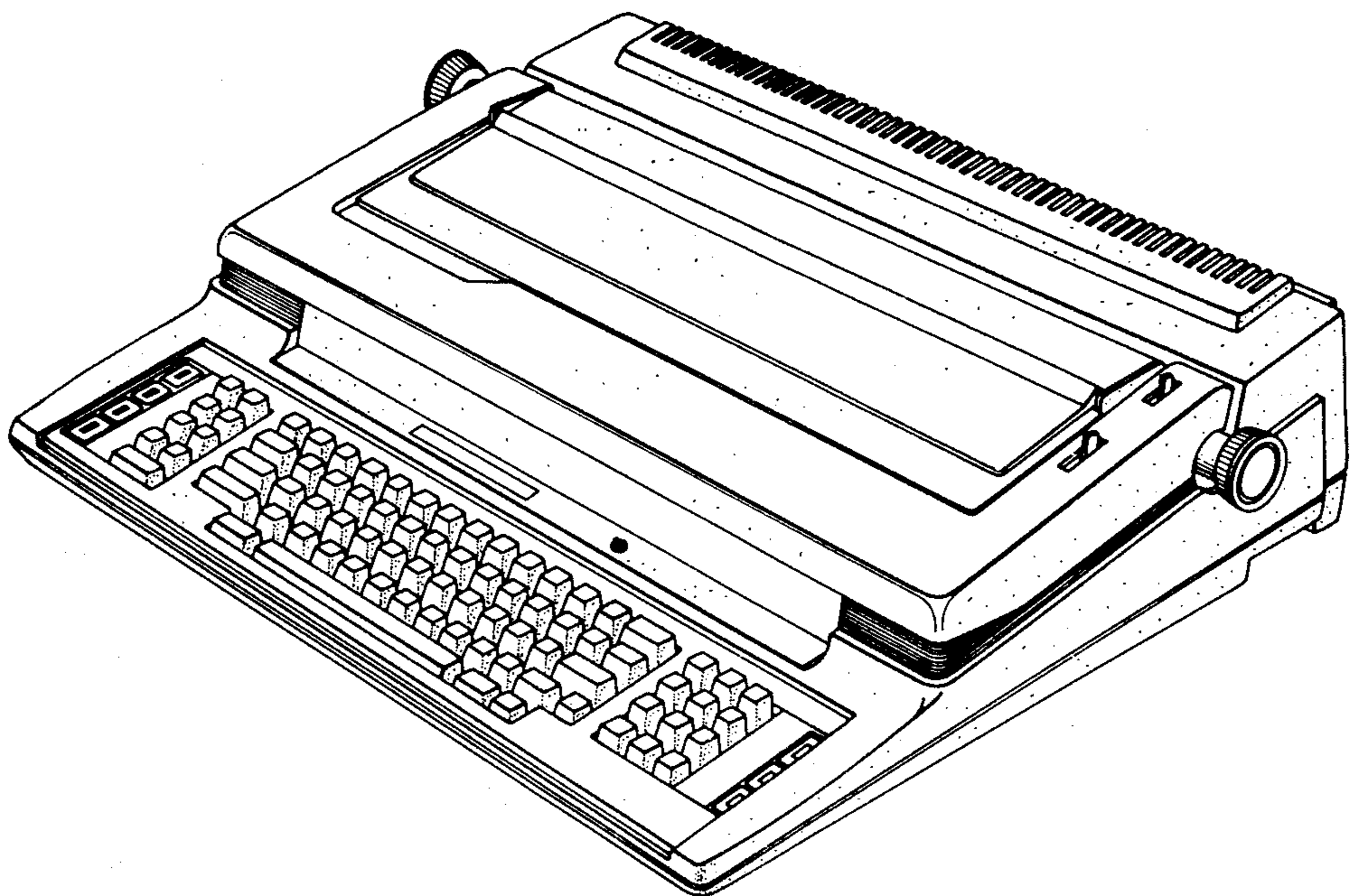

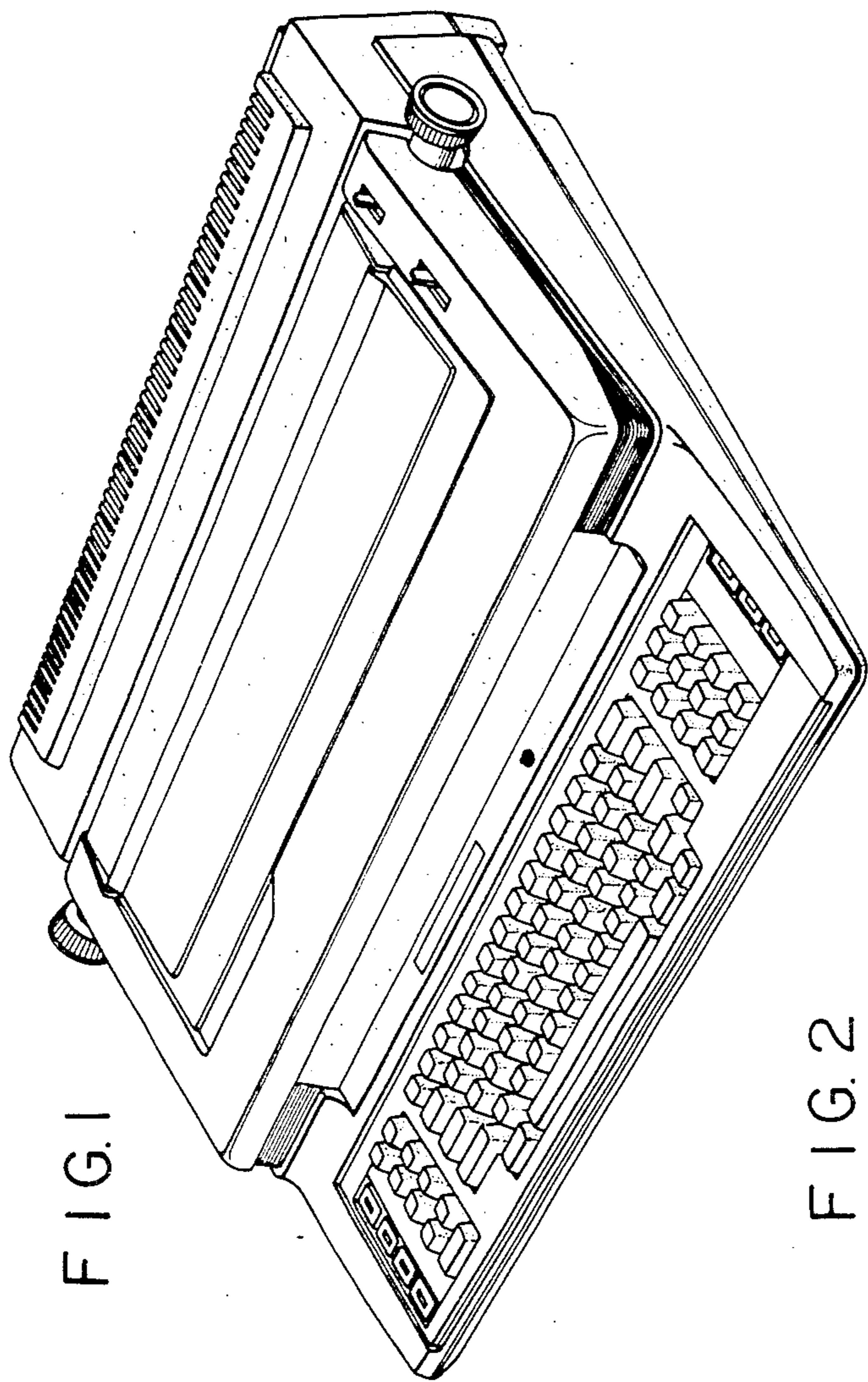

FIG. 1

FIG. 2

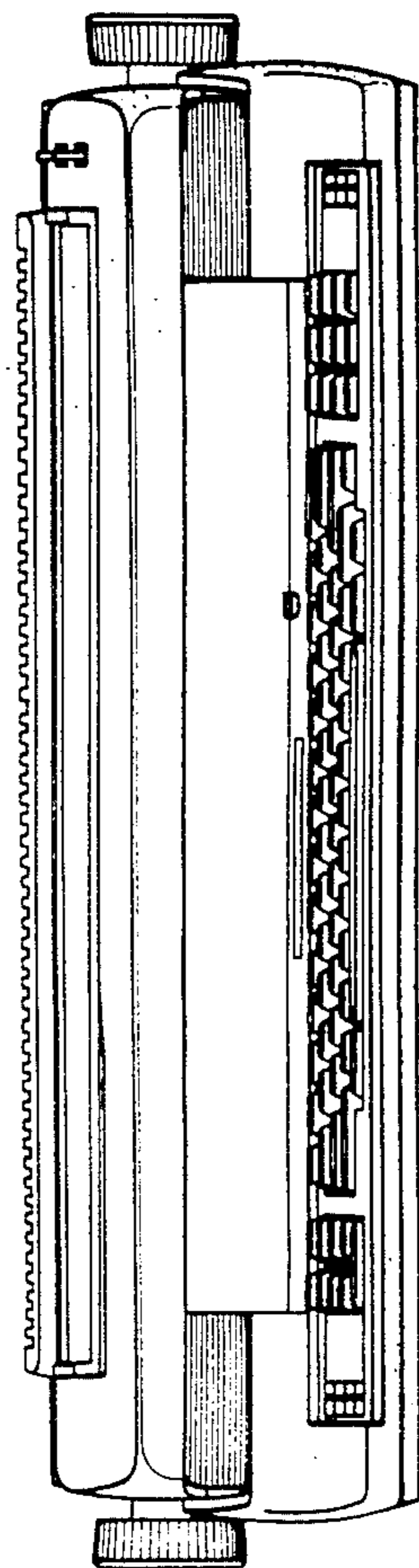

FIG. 3

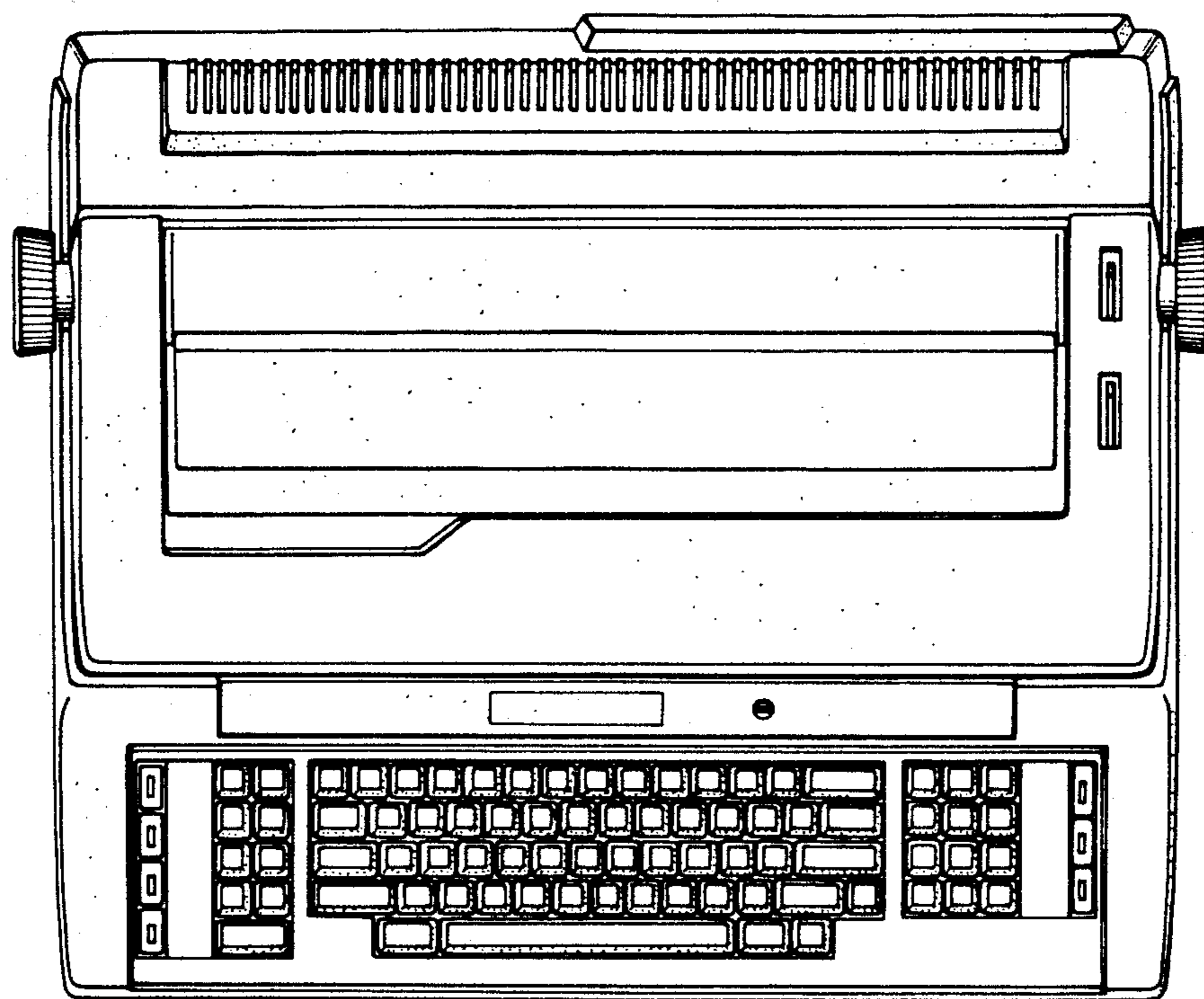

FIG. 4

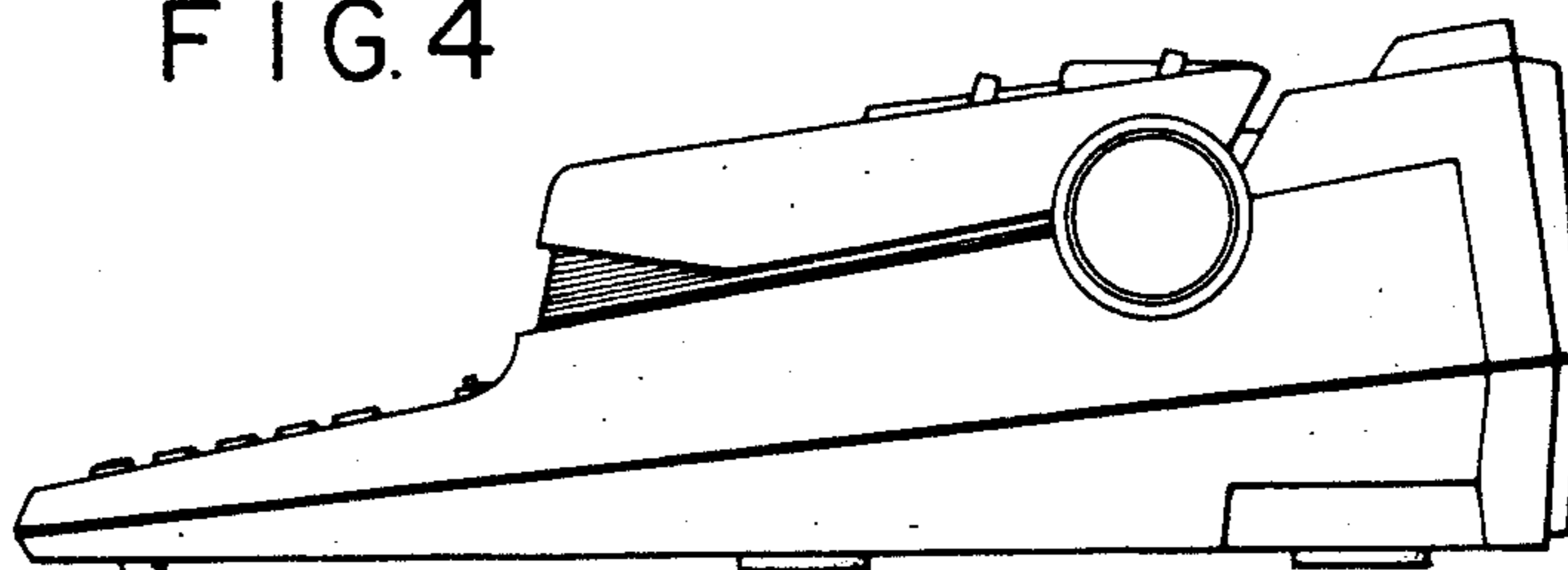

FIG. 5

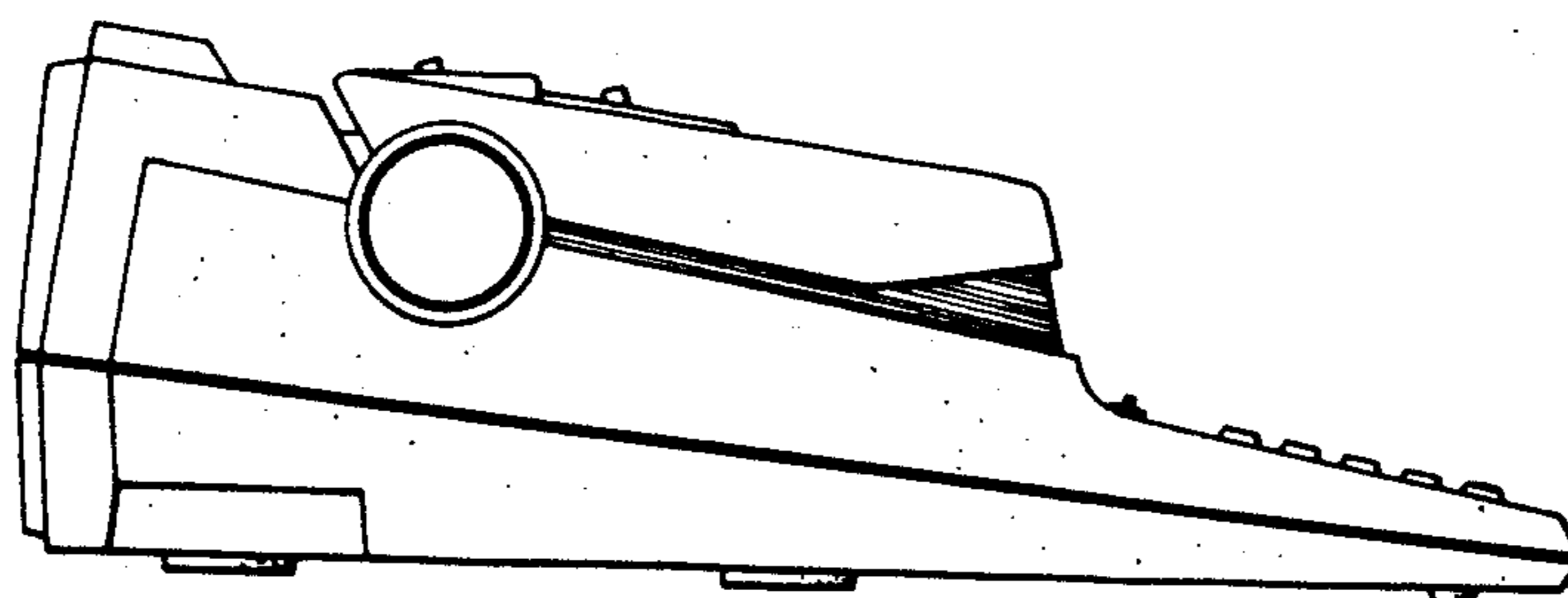

FIG. 6

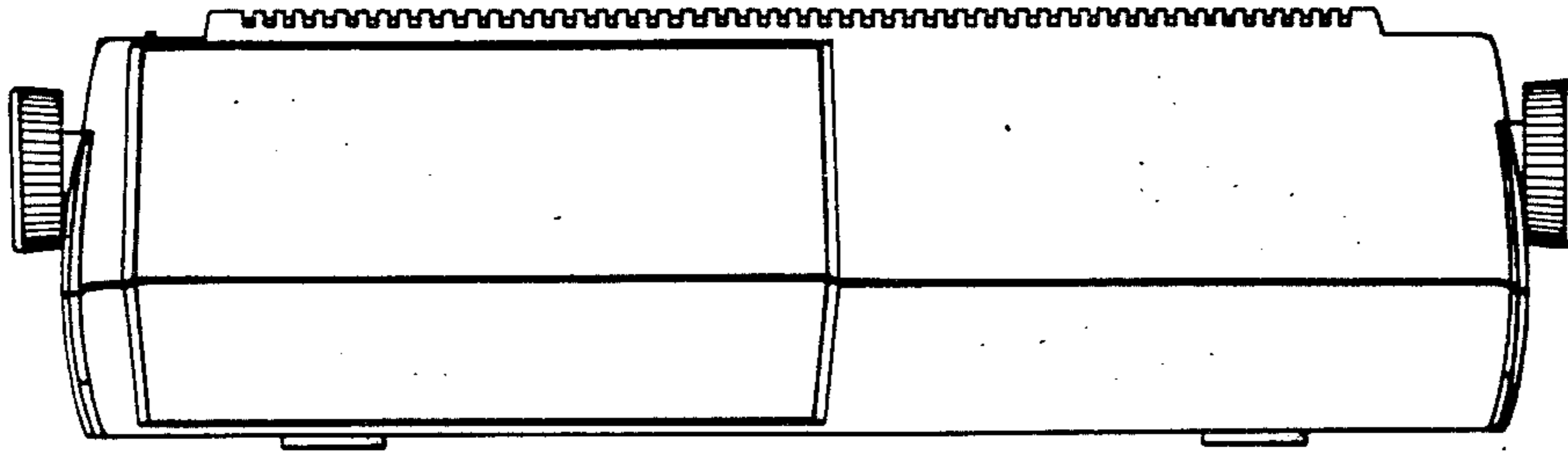
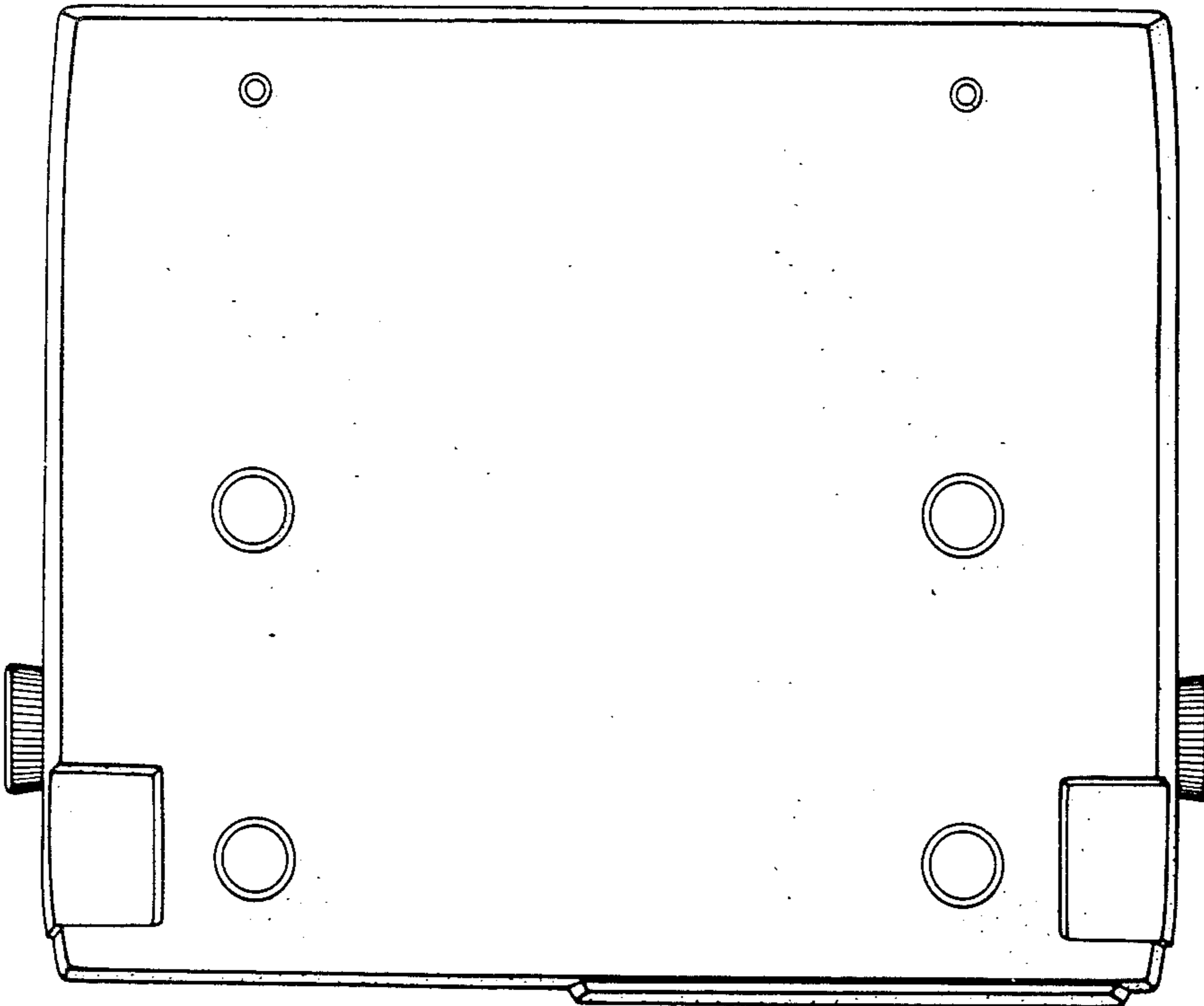

FIG. 7



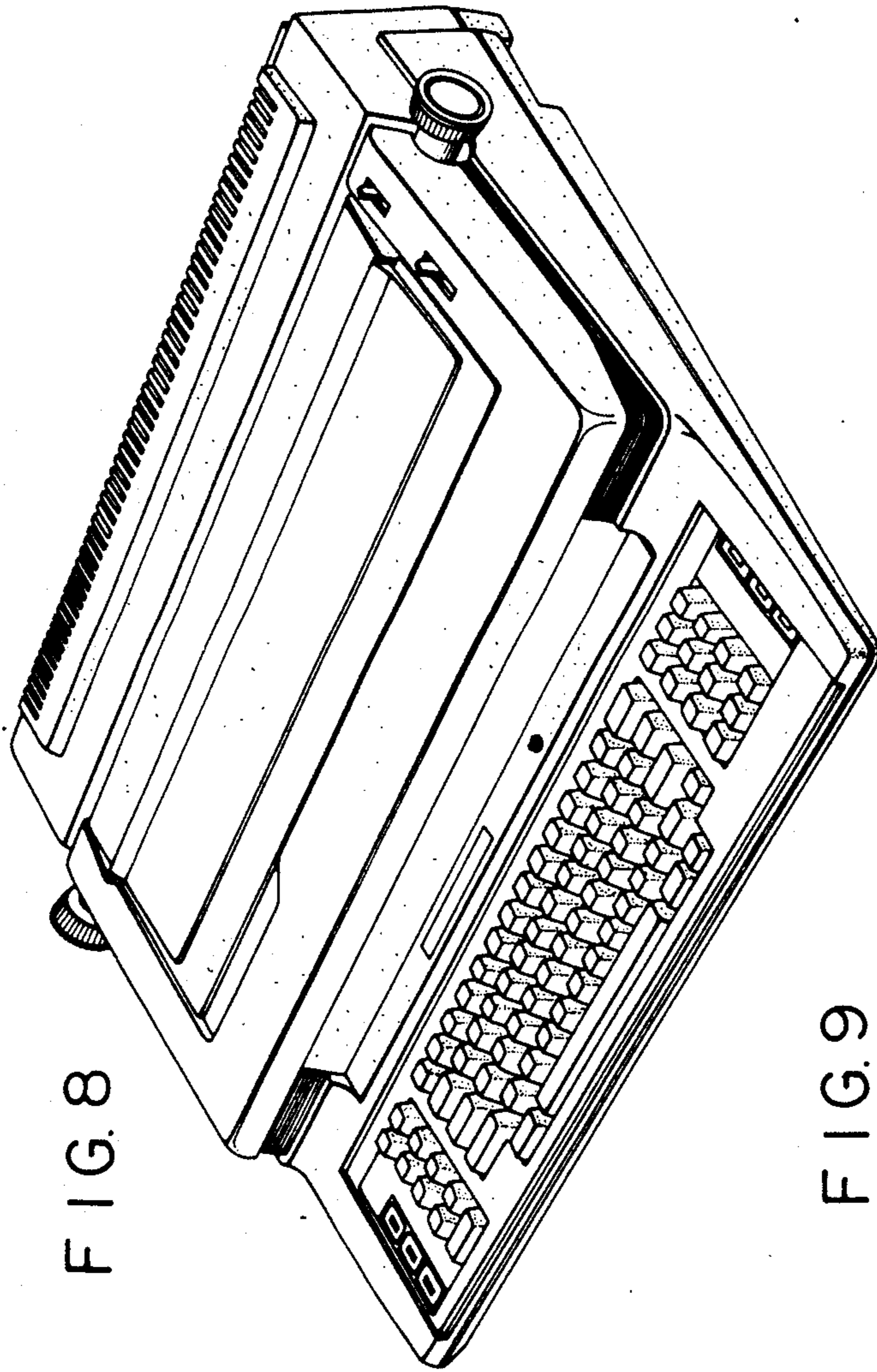

FIG. 8

FIG. 9

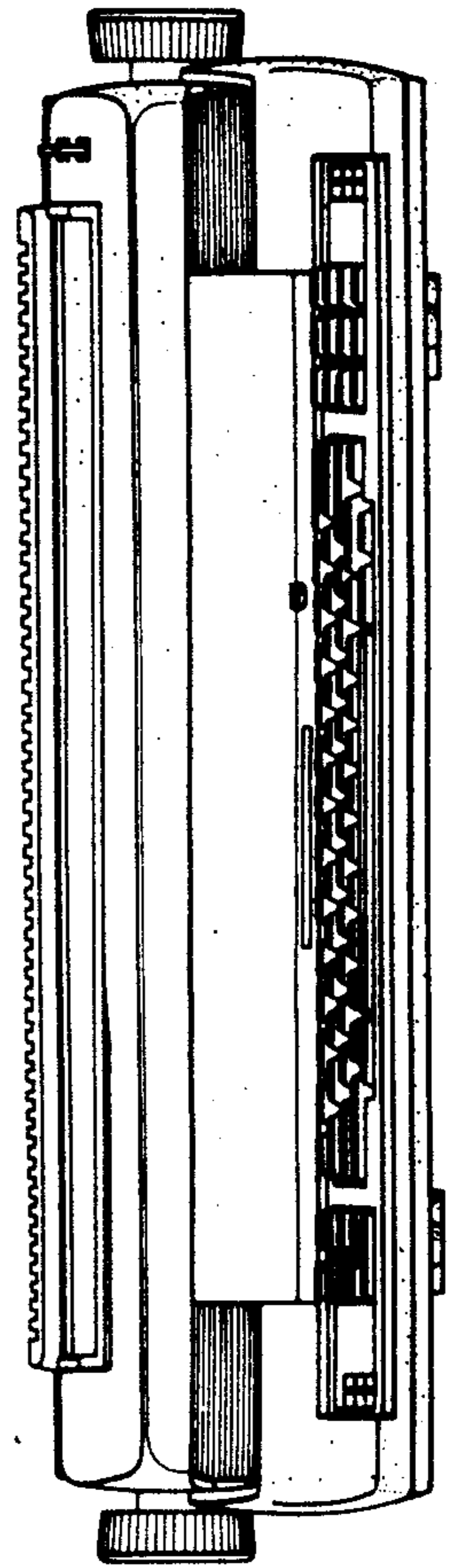

FIG. 10

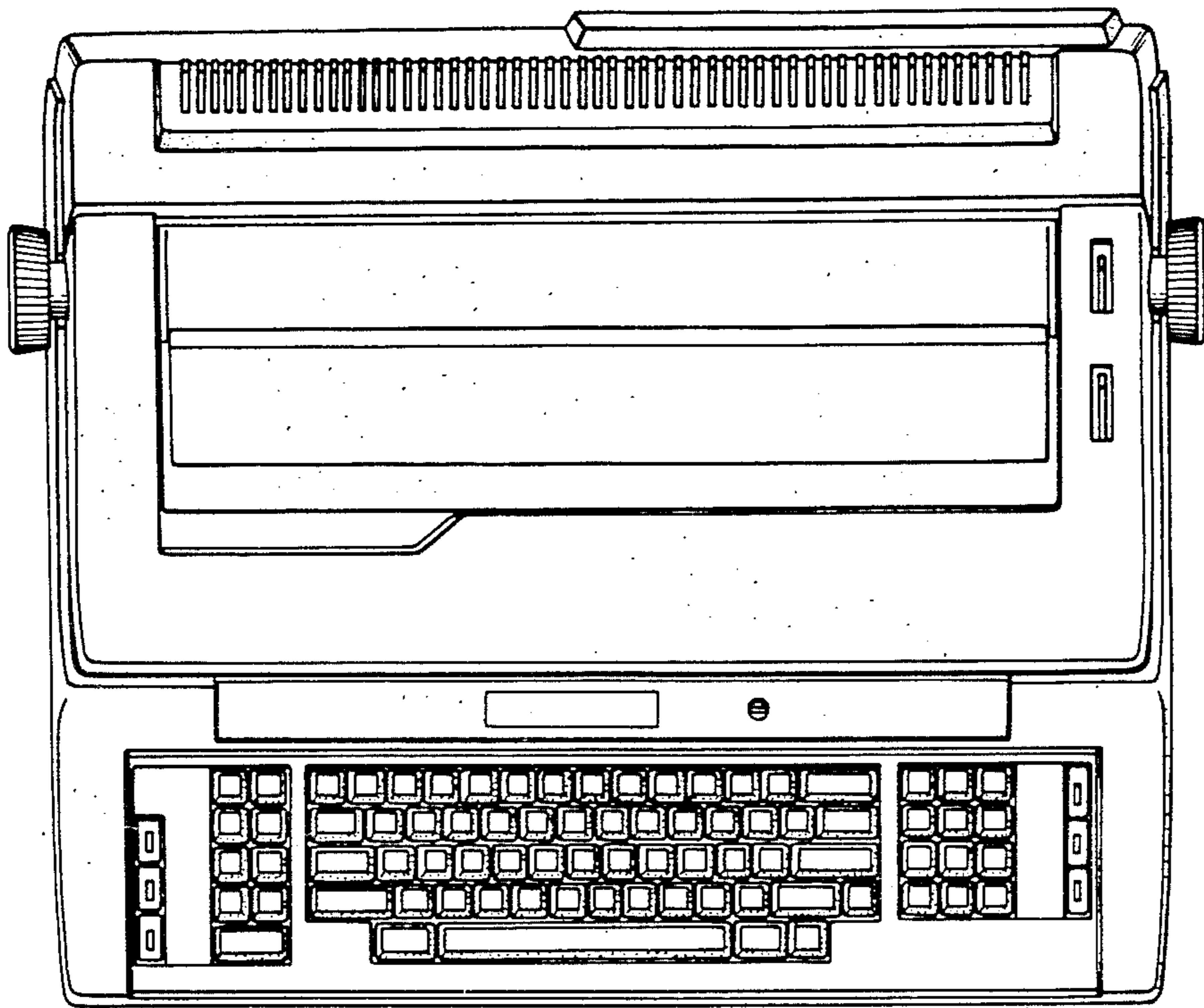

FIG. 11

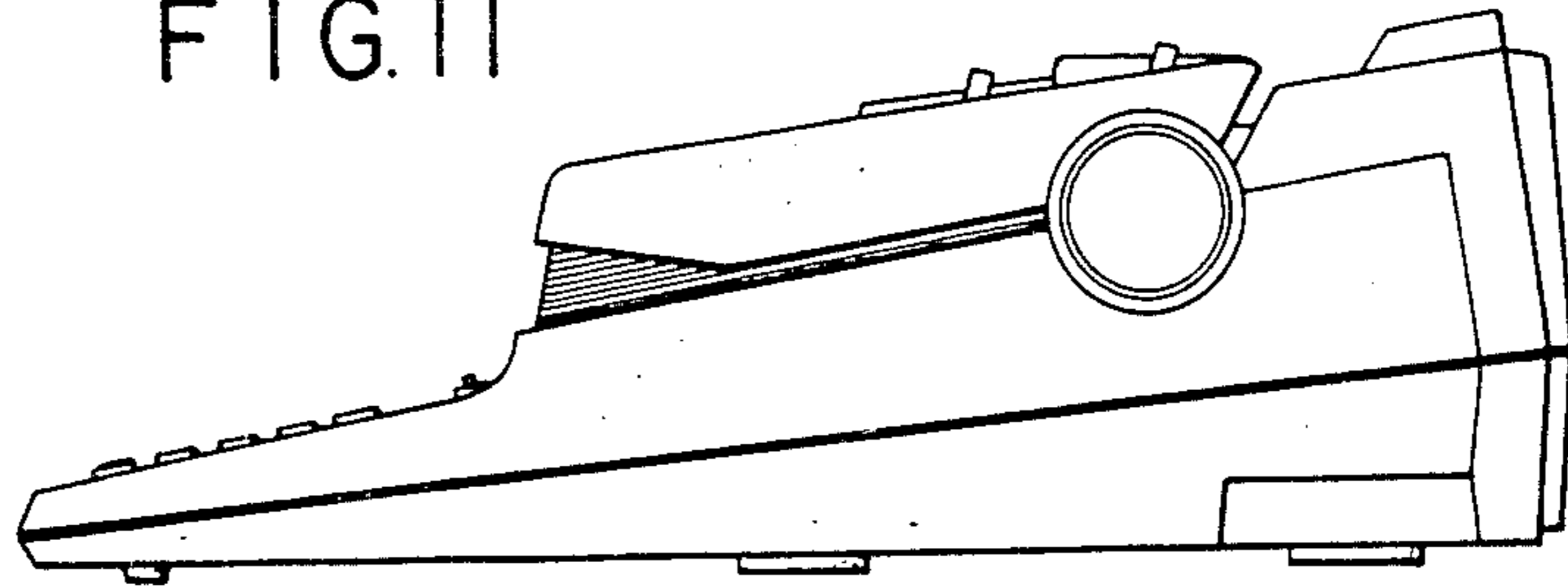

FIG. 12

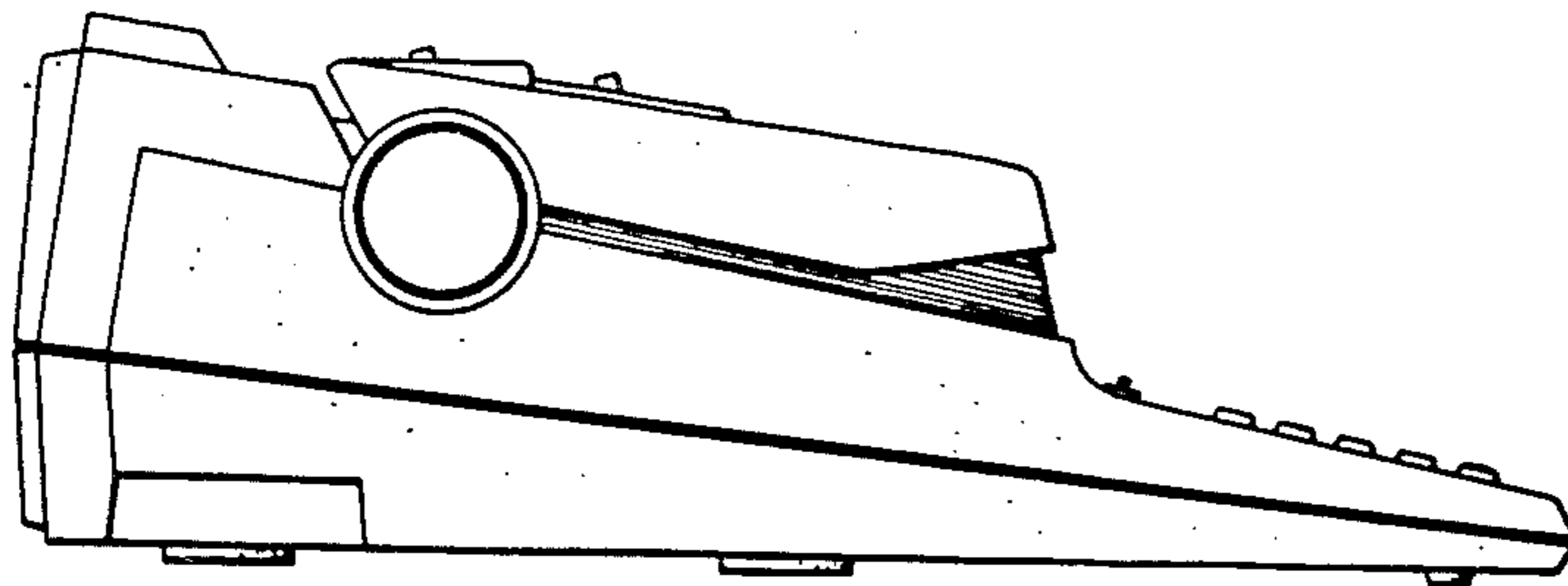

FIG. 13

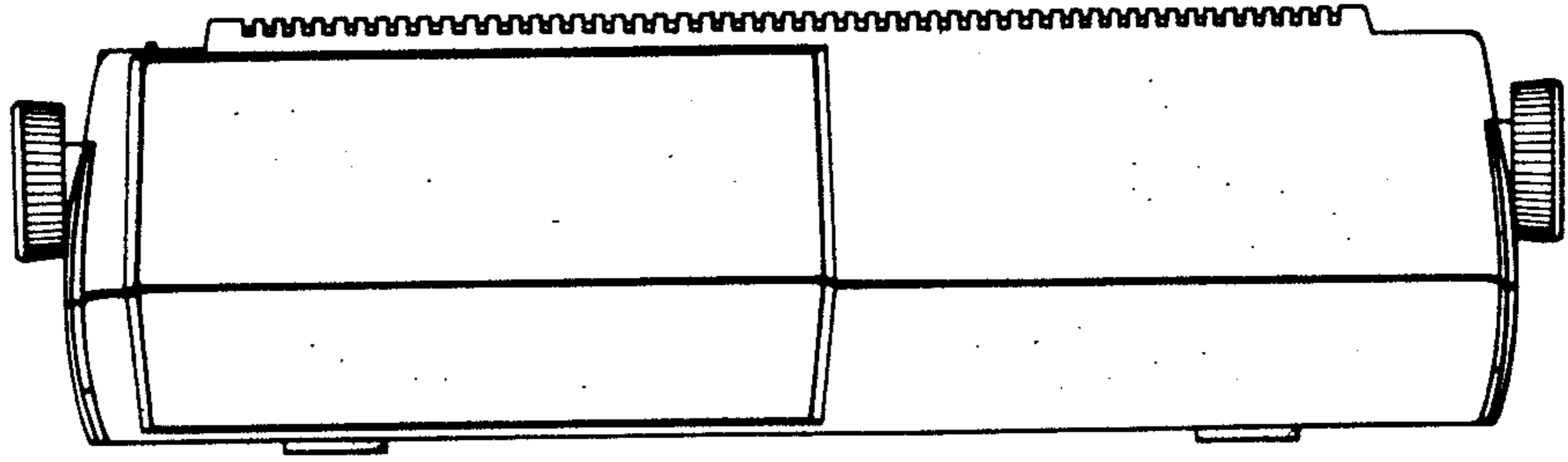

FIG. 14

