

[54] INSULATED MUG

[75] Inventors: Charles H. Feltman, Pacific Palisades; Dirk G. Langer, Venice, both of Calif.

[73] Assignee: A California General Partnership 2nd Wave, Venice, Calif.

[**] Term: 14 Years

[21] Appl. No.: 700,610

[22] Filed: Feb. 11, 1985

[52] U.S. Cl. D7/9

[58] Field of Search D7/9, 10, 7, 21, 39, D7/394, 70

[56] References Cited

U.S. PATENT DOCUMENTS

D. 195,348	6/1963	Christoffersen	D7/394
D. 204,295	4/1966	Brekke	D7/70
D. 216,731	3/1970	Tsoo-Hing et al.	D7/9
D. 225,885	1/1973	Doman et al.	D7/9
D. 232,010	7/1974	Steinmann	D7/9
3,257,025	6/1966	Jolly	D7/70 X
4,130,215	12/1978	Corey	D7/9 X

OTHER PUBLICATIONS

Gifts & Decorative Accessories, Jun. 1984, p. 157, top Mug by "Bearly Surviving-Feltman/Langer.

Primary Examiner—Winifred E. Herrmann
Attorney, Agent, or Firm—Thomas I. Rozsa

[57] CLAIM

The ornamental design for an insulated mug, as shown and described.

DESCRIPTION

FIG. 1 is a top, and right side perspective view of an insulated mug showing our new design;
 FIG. 2 is a top plan view thereof;
 FIG. 3 is a front elevational view thereof;
 FIG. 4 is a right side elevational view thereof with the left side elevational view being identical thereto;
 FIG. 5 is a back elevational view thereof;
 FIG. 6 is a bottom plan view thereof;
 FIG. 7 is a right side elevational view of a modified form of the insulated mug in FIG. 1 with the remainder of the views being identical, the only difference being the bottom ring portion as shown herein;
 FIG. 8 is a right side elevational view of another modified form of the insulated mug in FIG. 1 with the remainder of the views being identical, the only difference being the handle shape as shown herein; and
 FIG. 9 is a right side elevational view of still another modified form of the insulated mug in FIG. 1 with the handle shape depicted in FIG. 8 and with the bottom ring portion depicted in FIG. 7, all as shown herein.

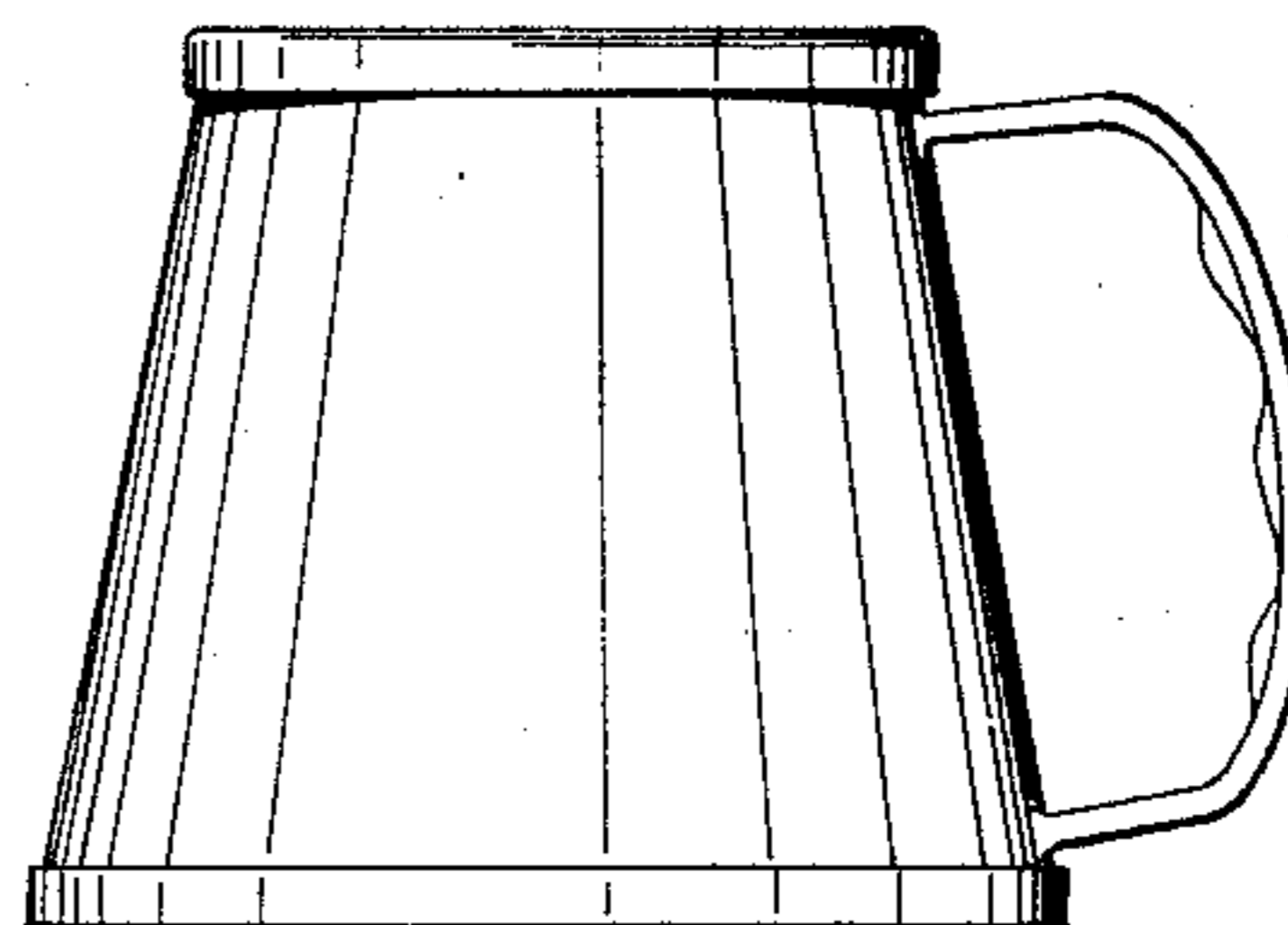
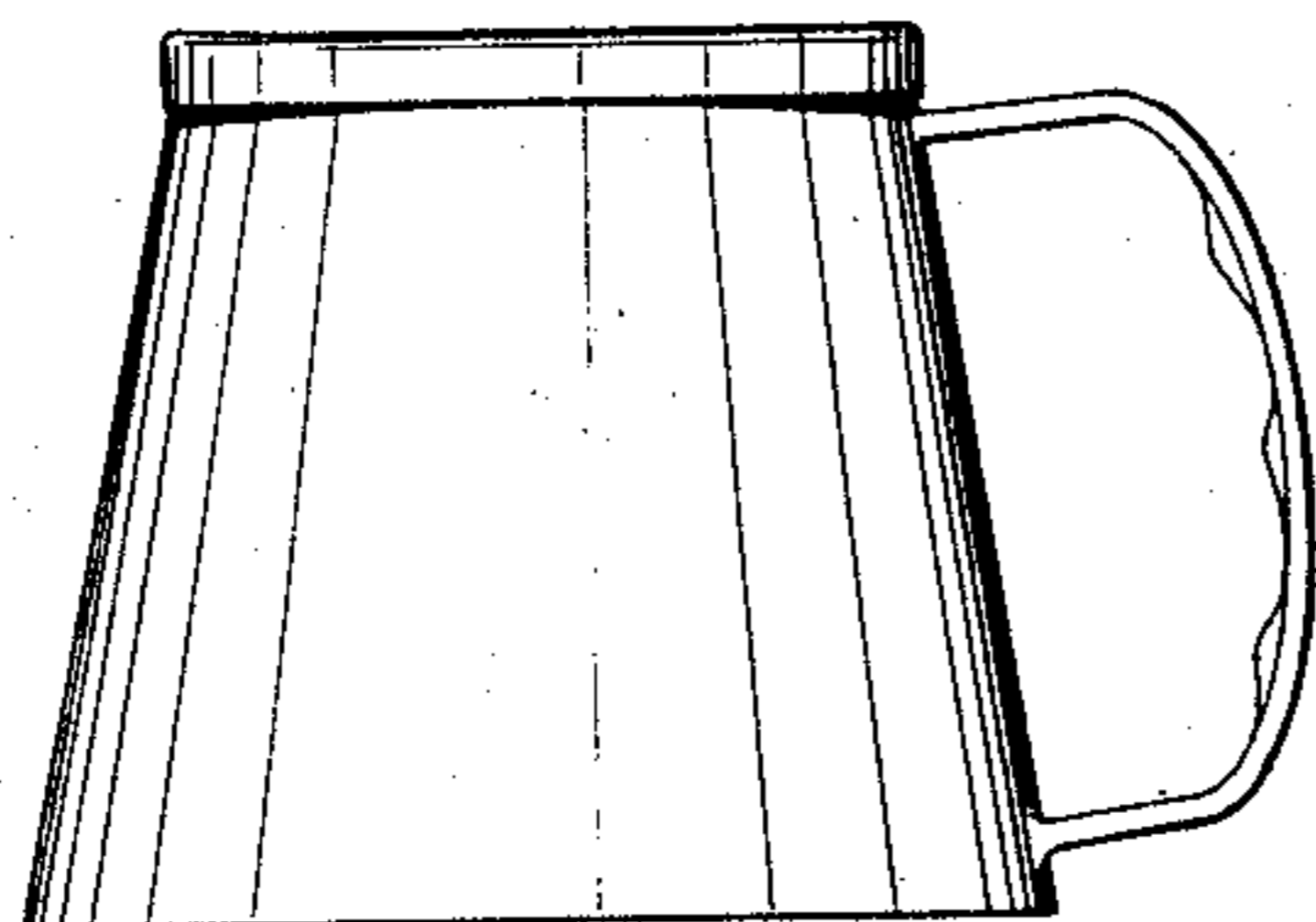
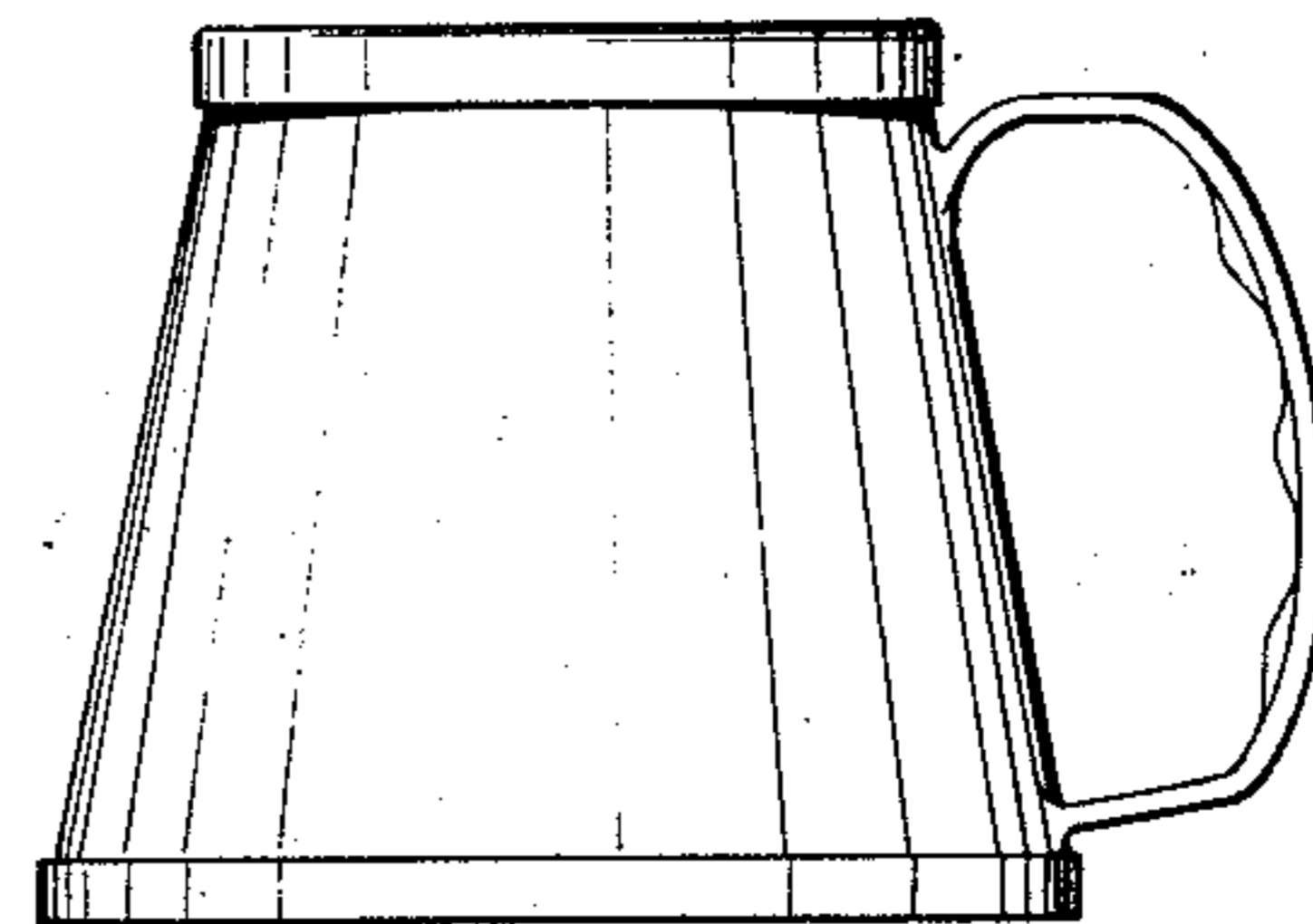
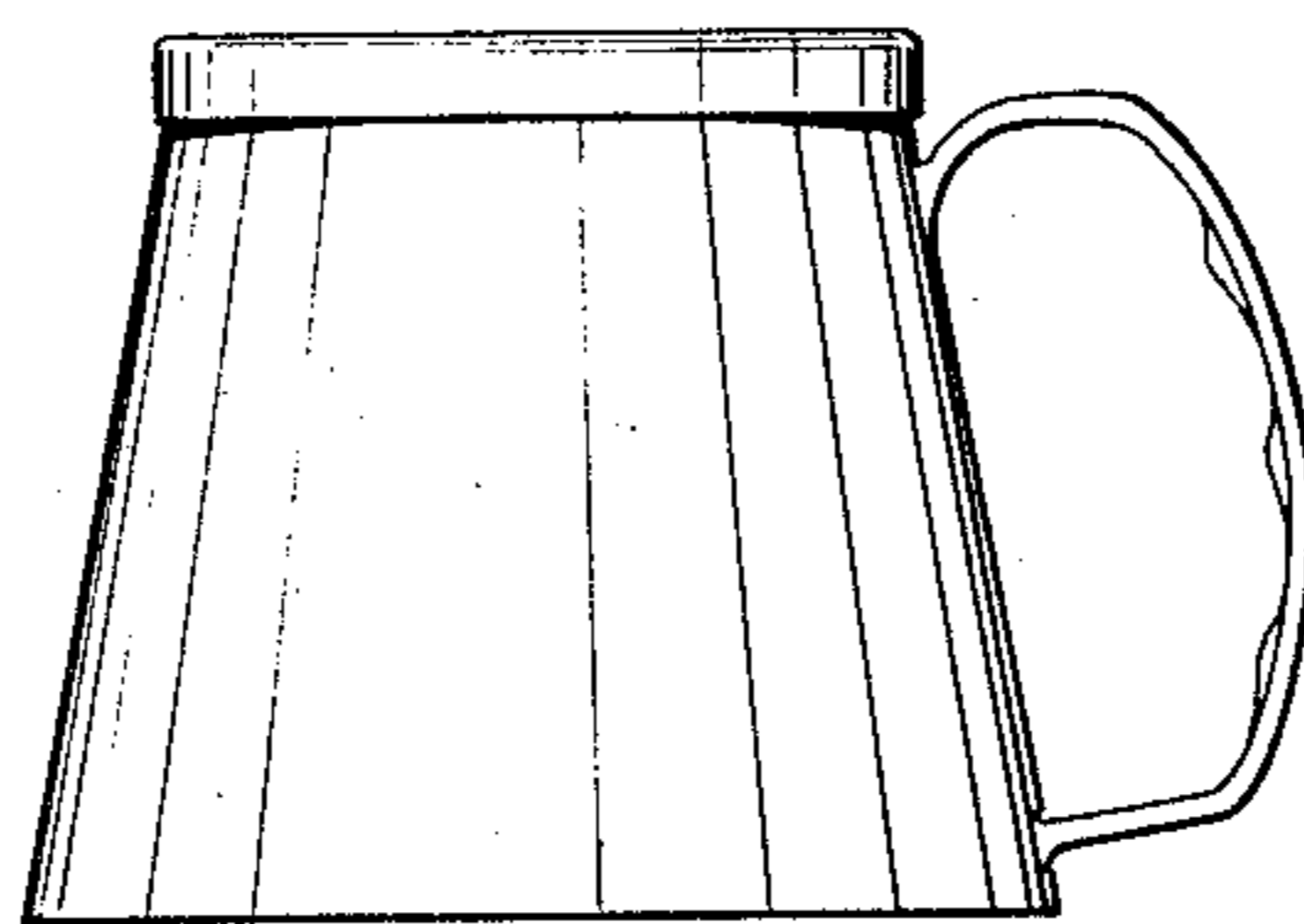
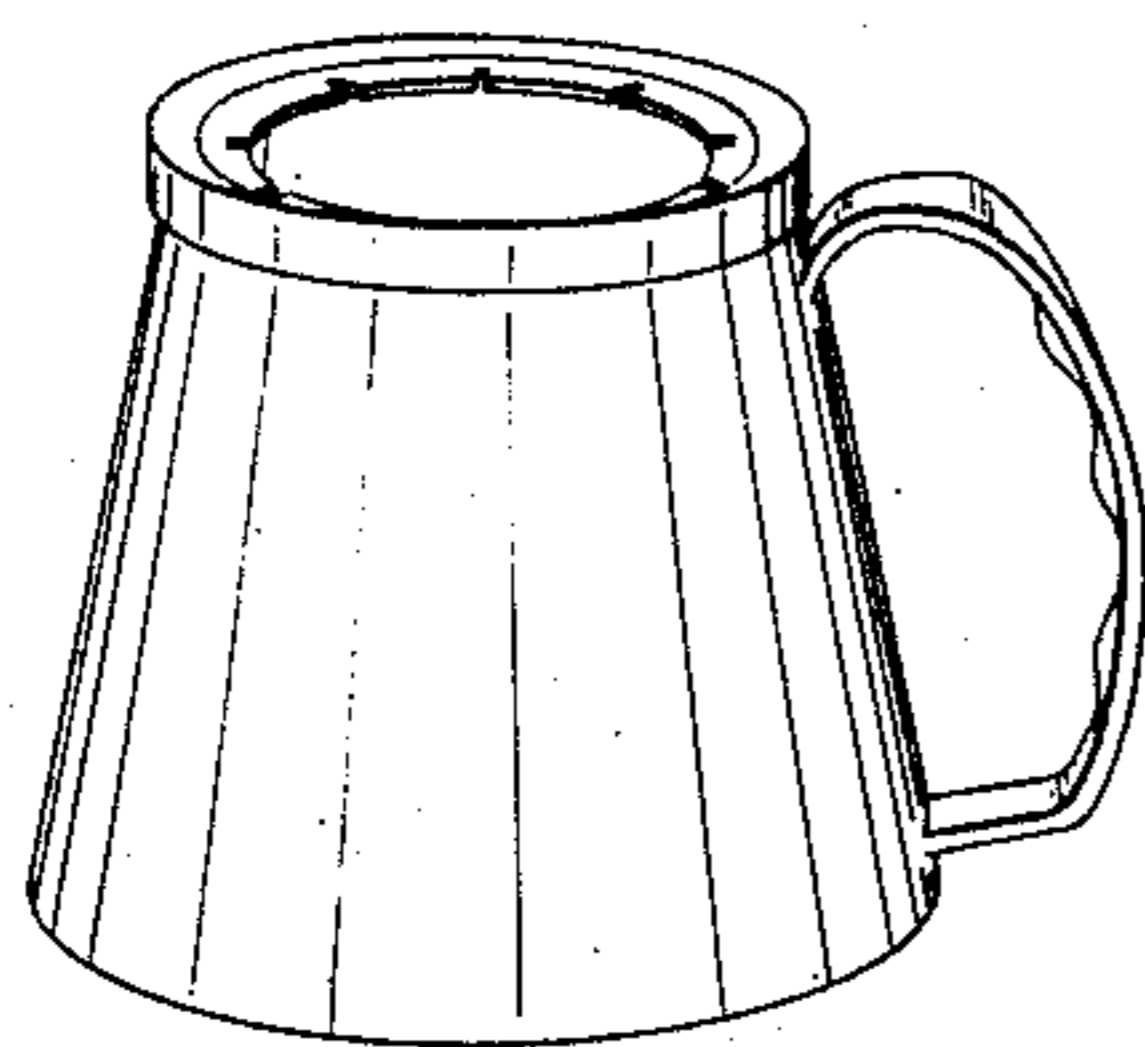

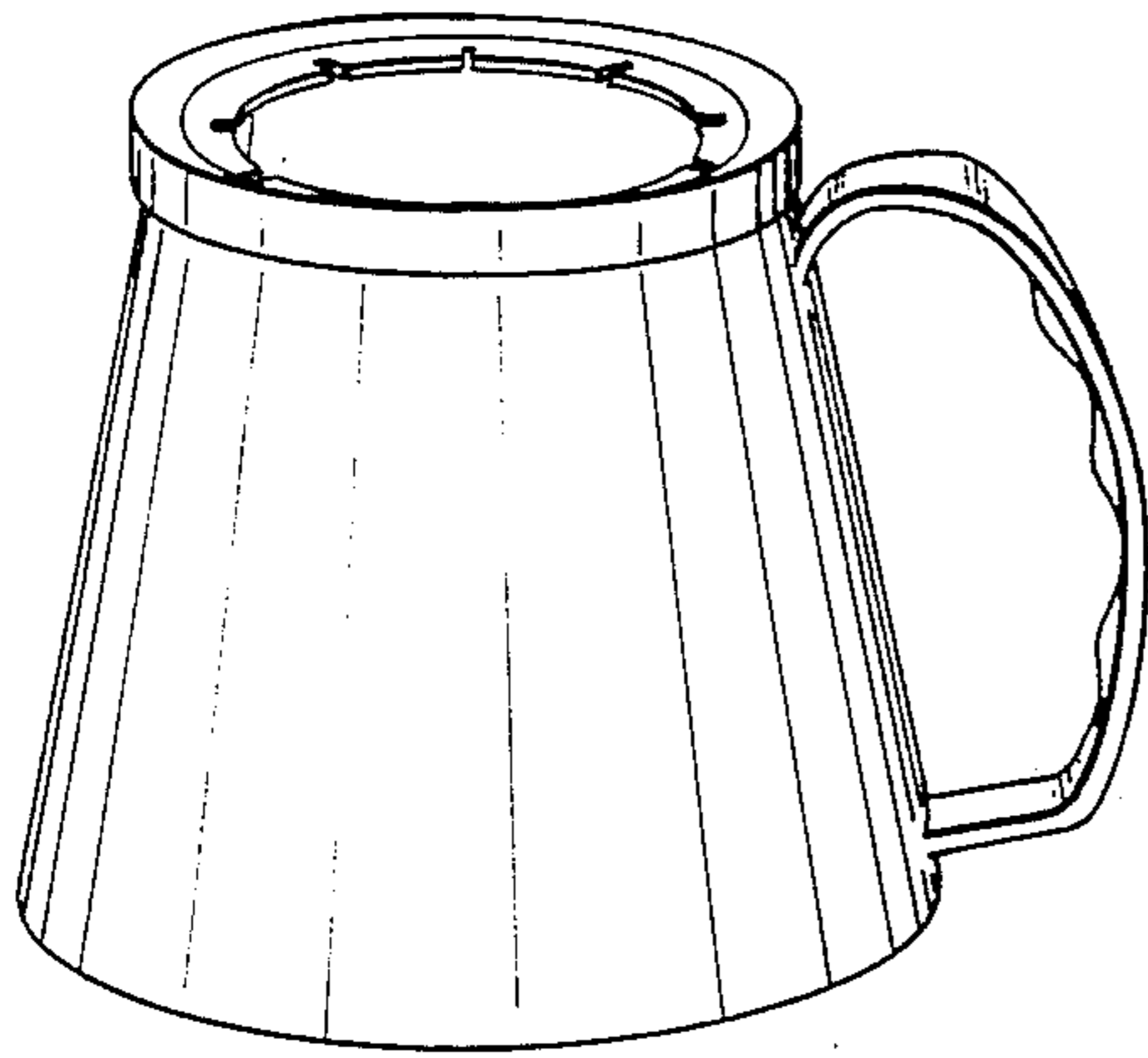

Fig. 1.

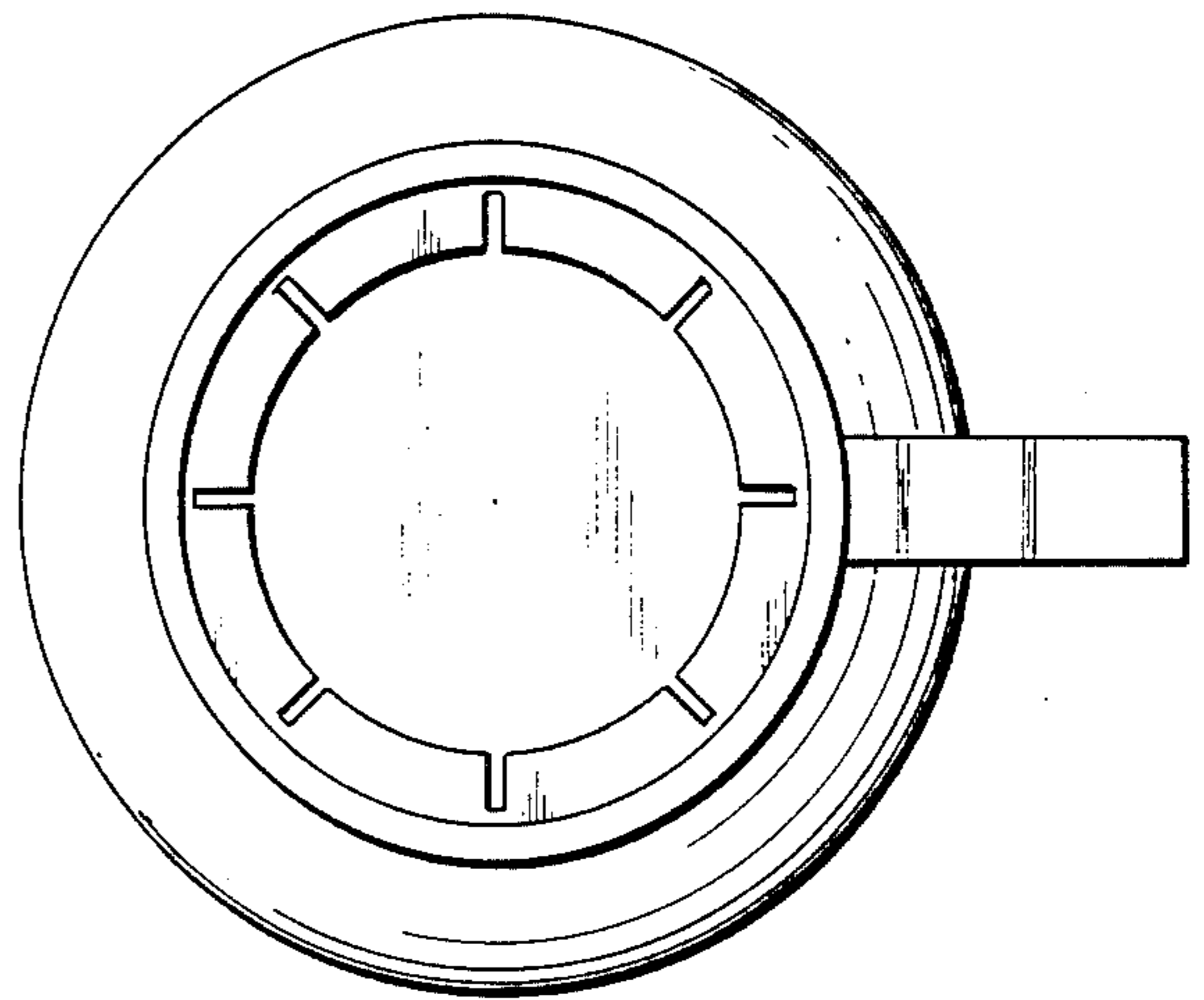

Fig. 2.

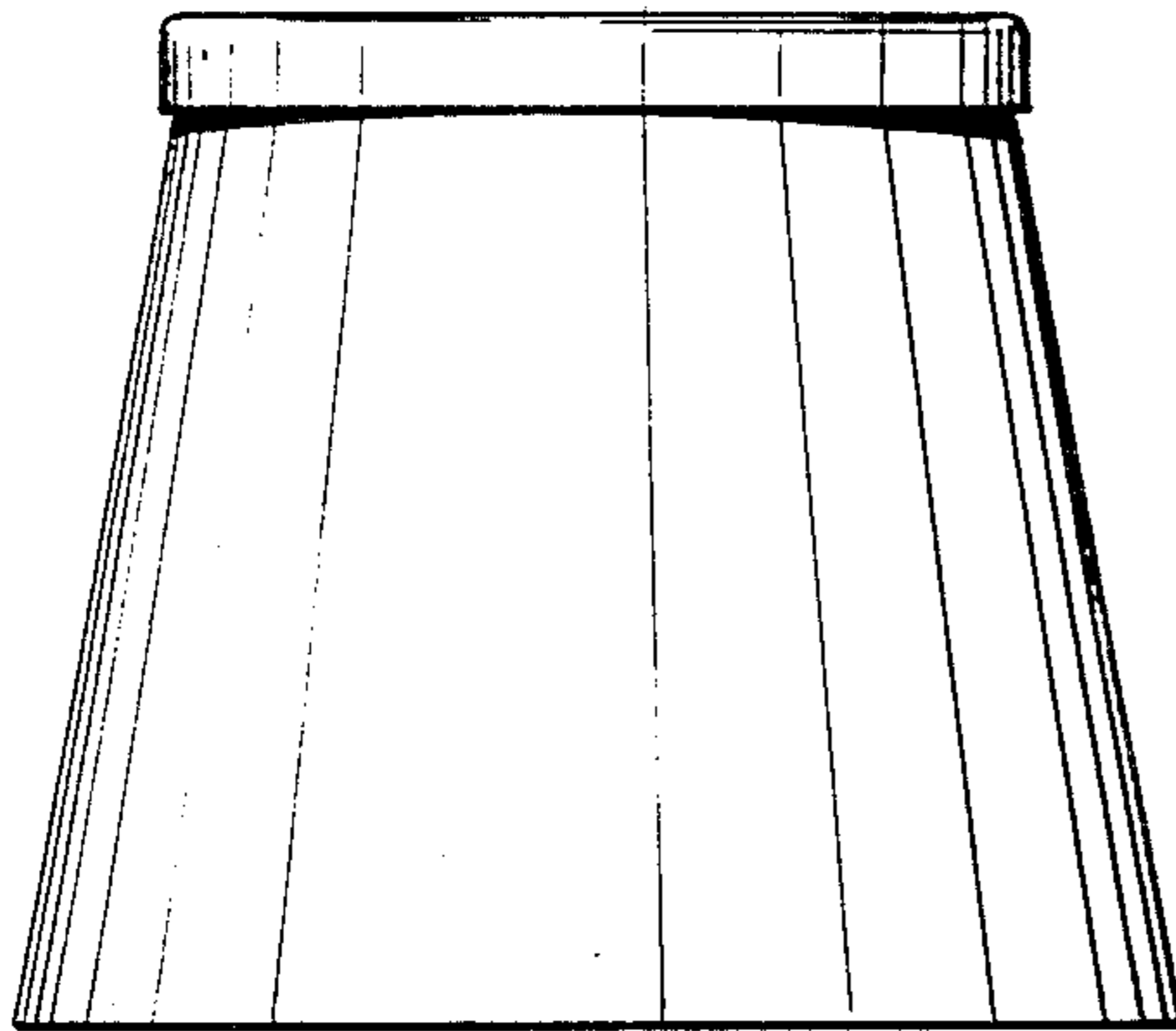

Fig. 3.

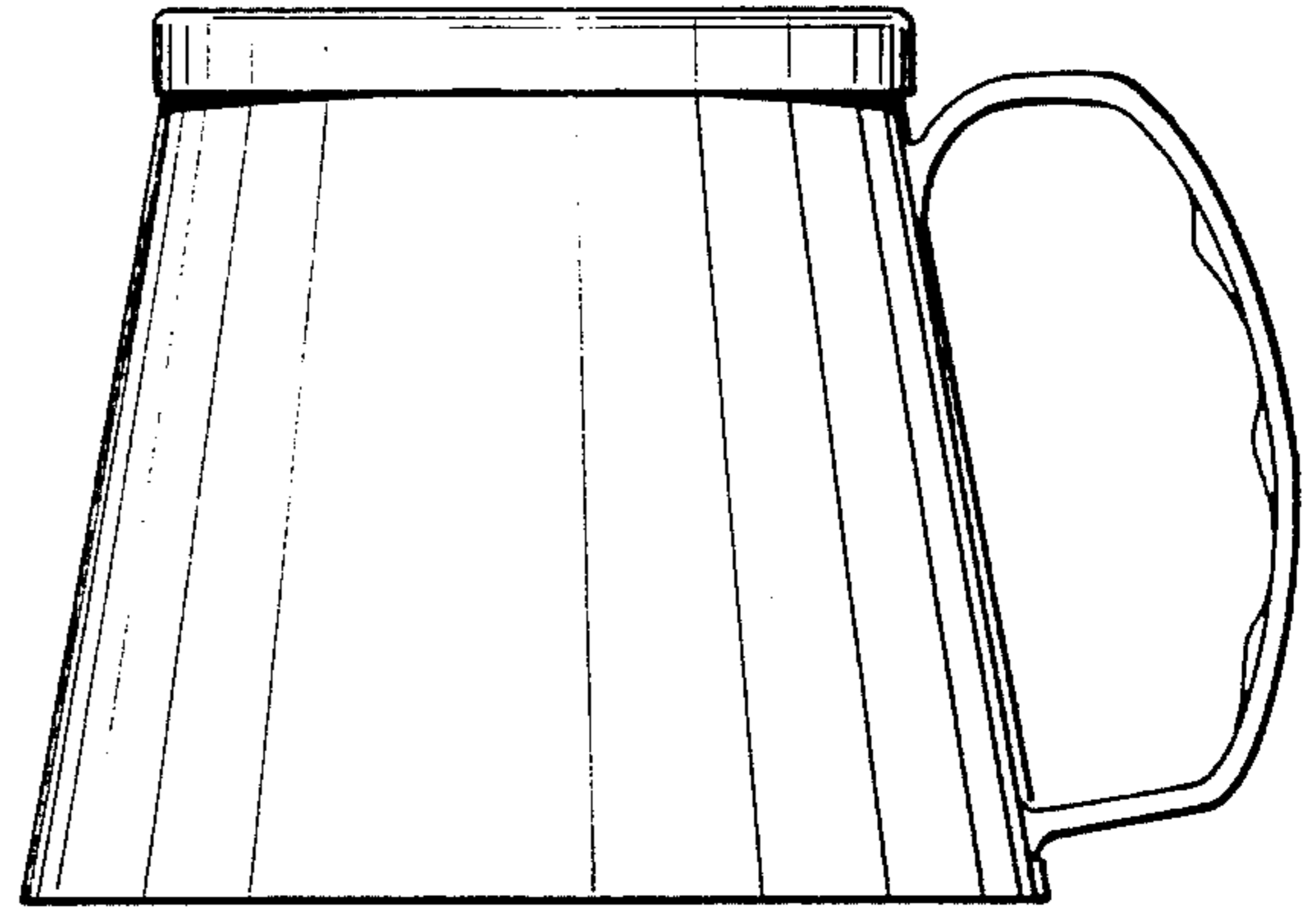

Fig. 4.

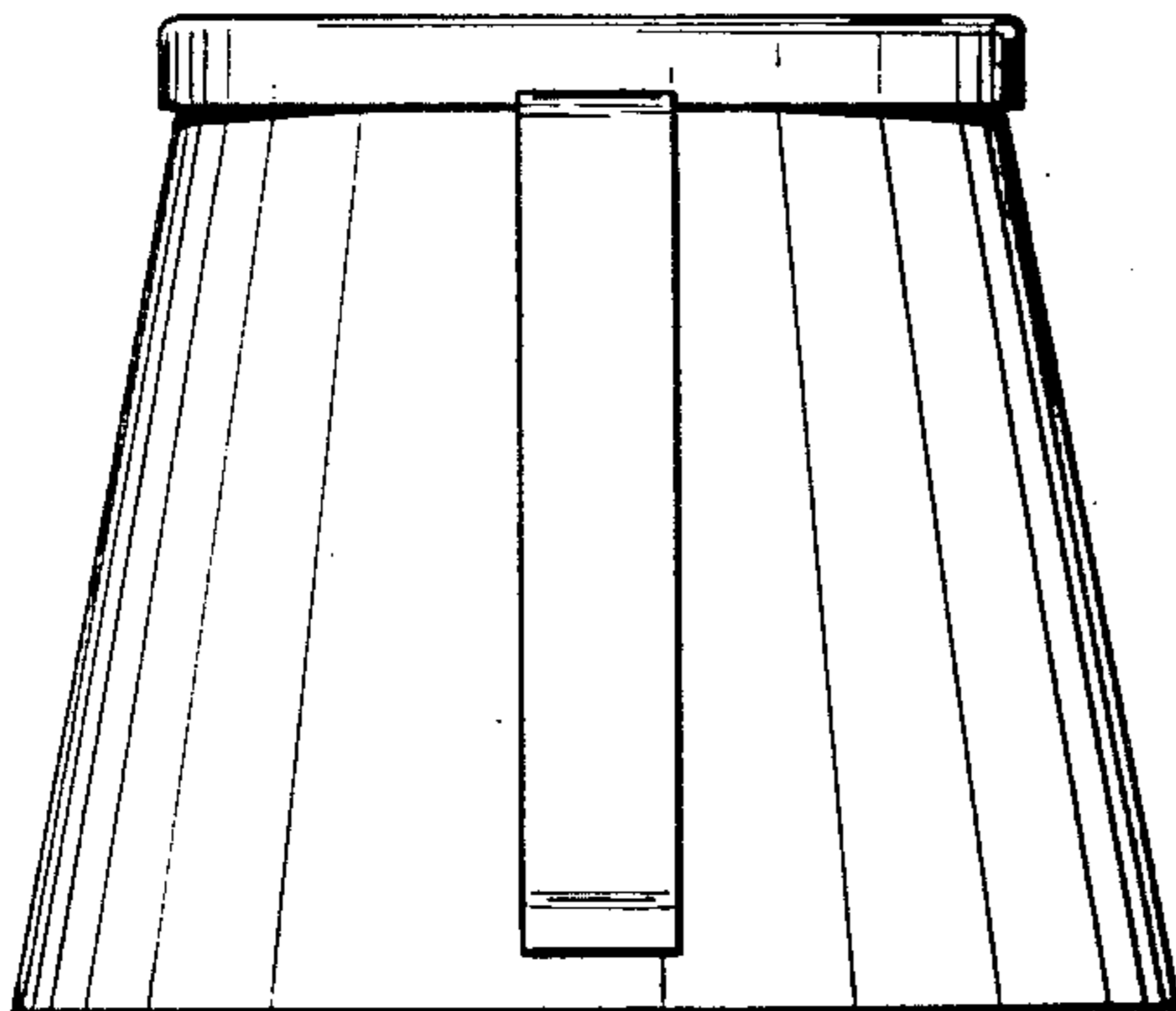

Fig. 5.

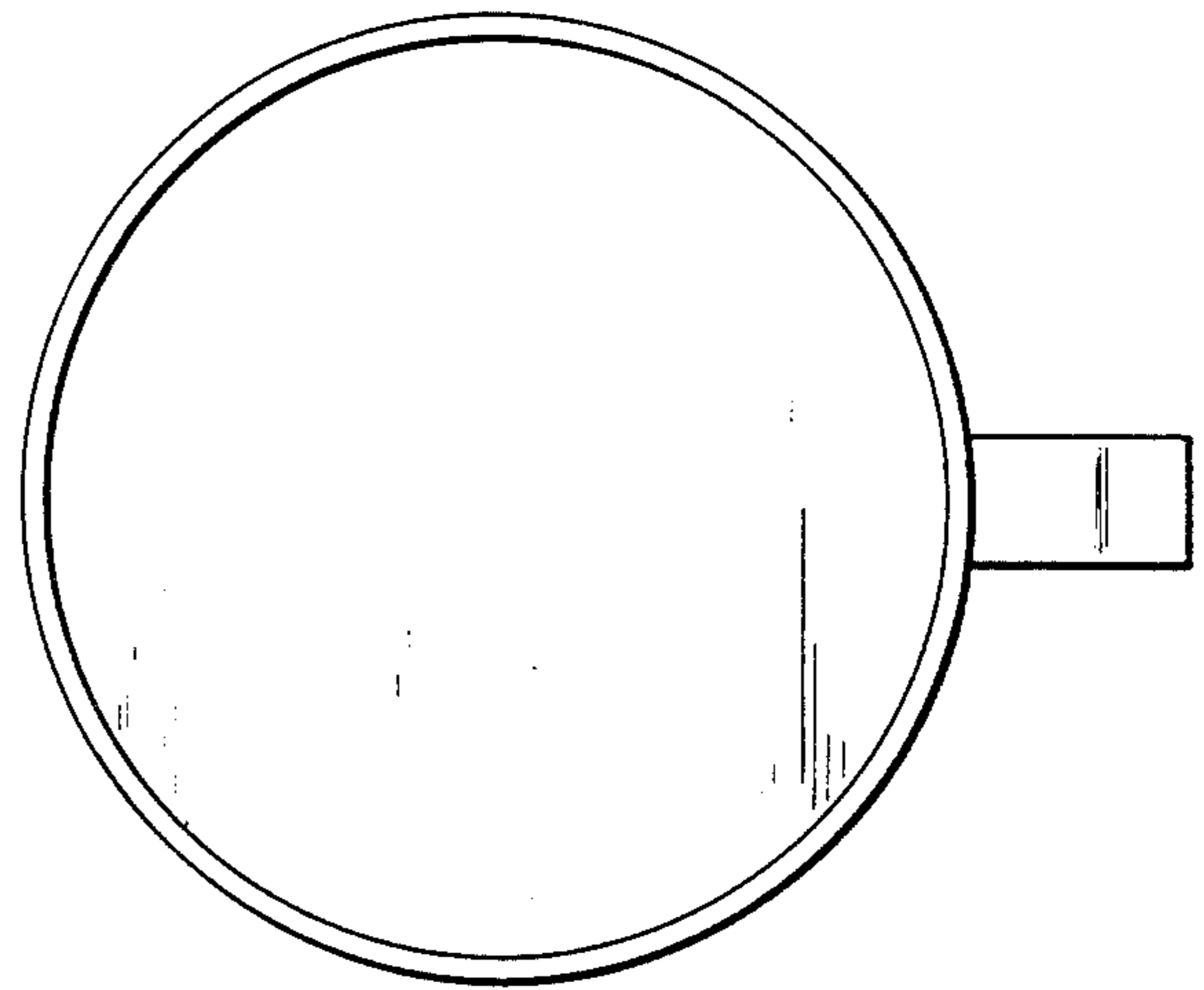

Fig. 6.

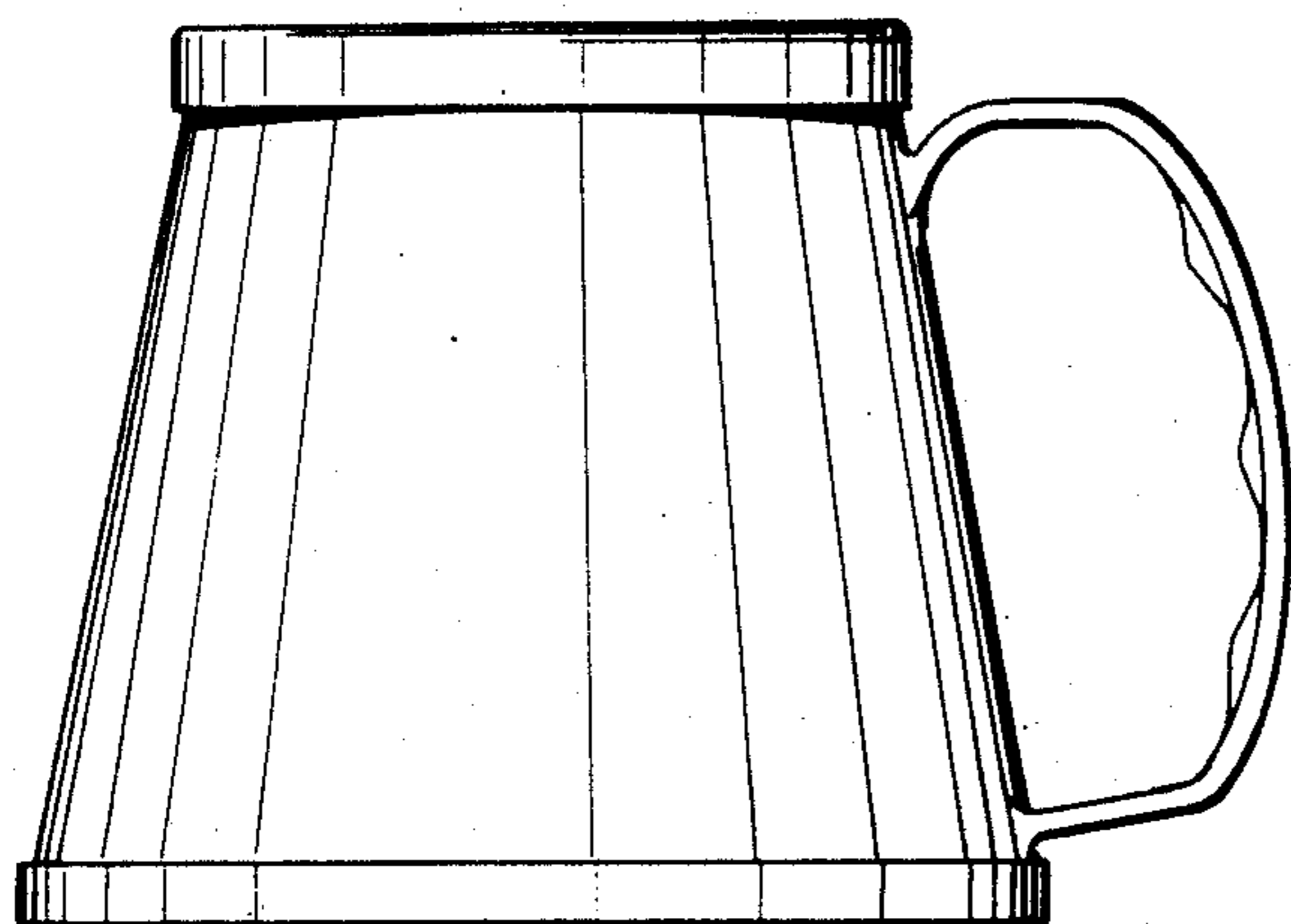

Fig. 7.

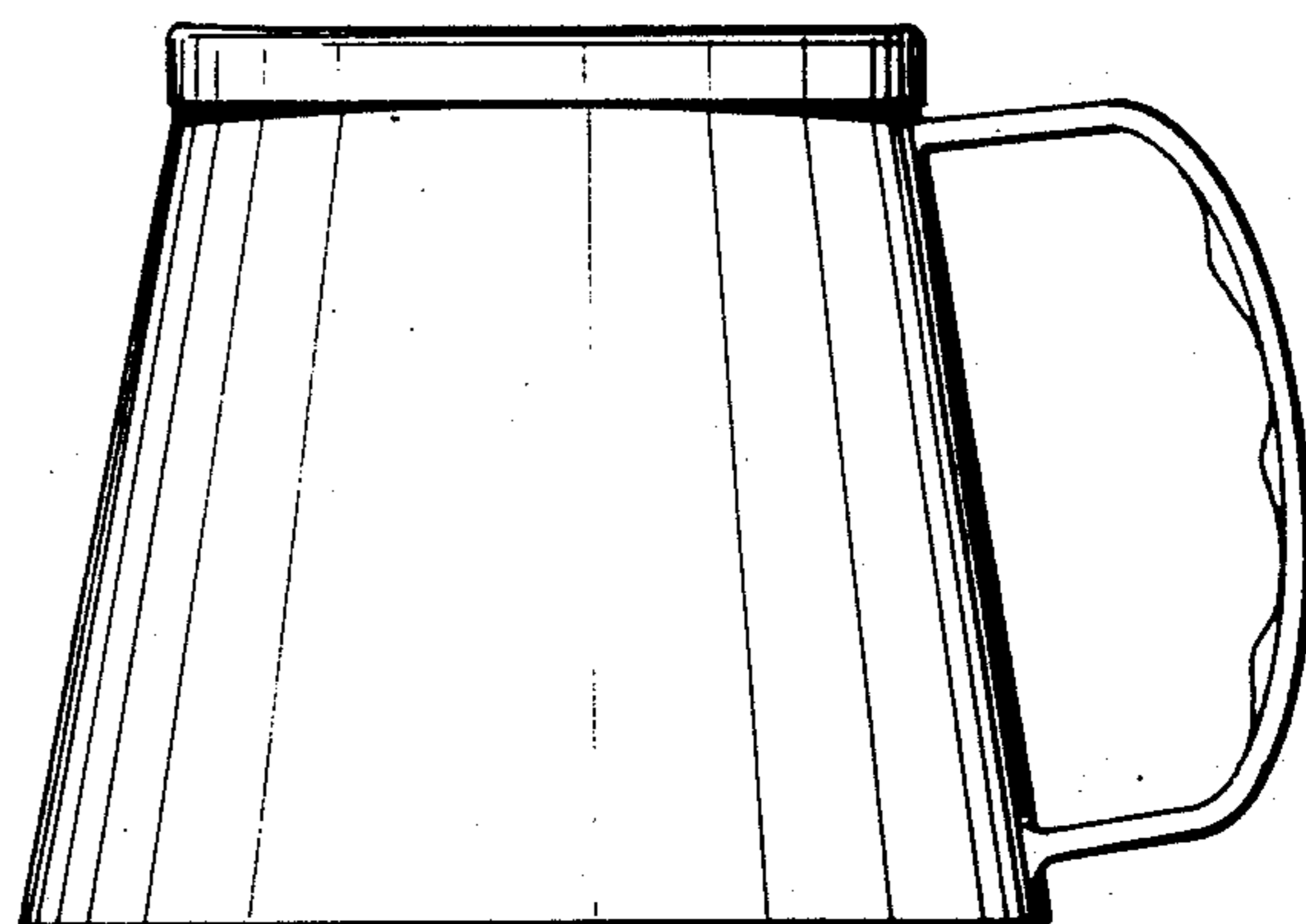

Fig. 8.

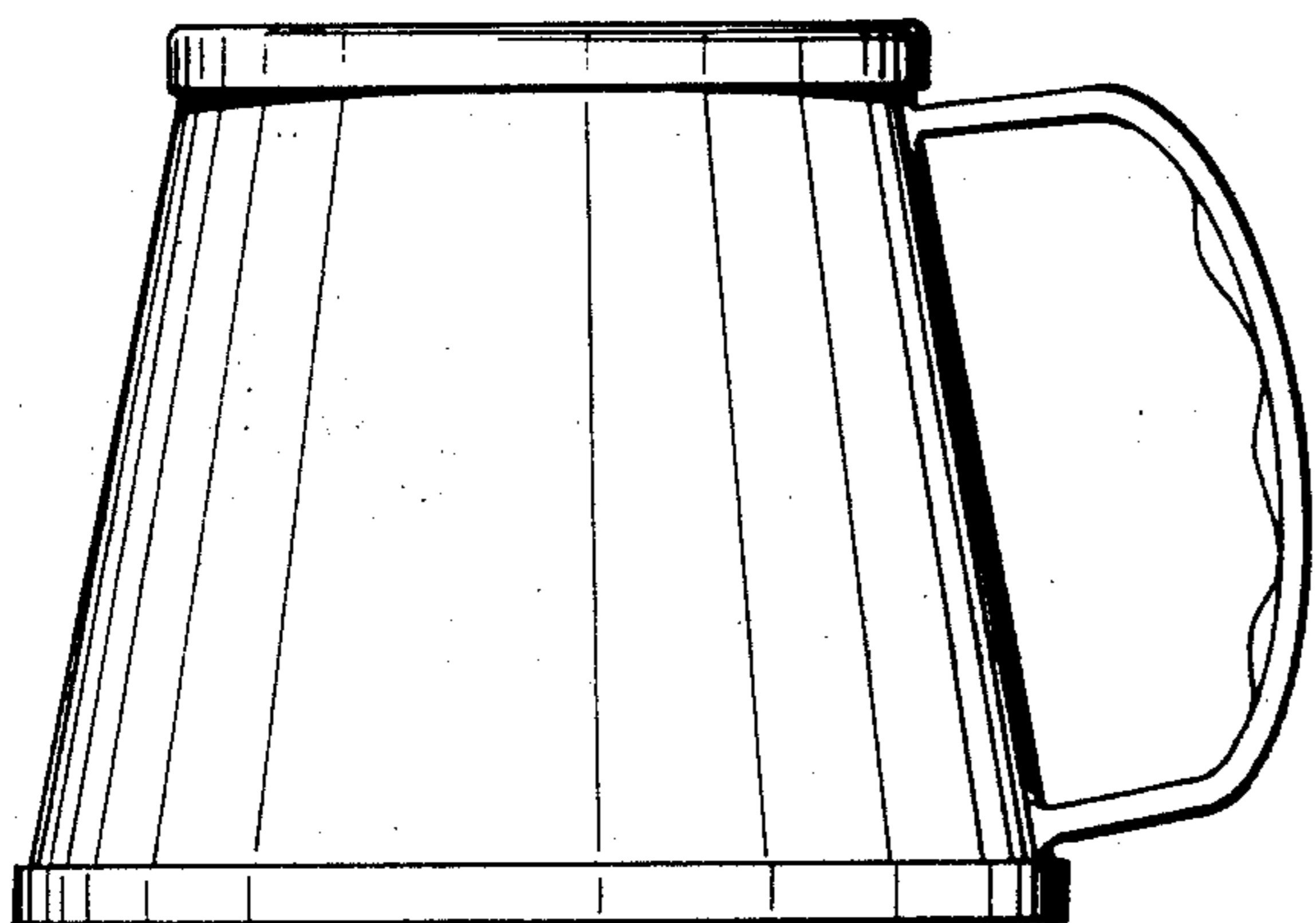

Fig. 9.