

[54] SOFA

[75] Inventor: William B. Raftery, Arlington, Tex.

[73] Assignee: Steelcase, Inc., Grand Rapids, Mich.

[**] Term: 14 Years

[21] Appl. No.: 789,556

[22] Filed: Oct. 21, 1985

Related U.S. Application Data

[62] Division of Ser. No. 494,299, May 13, 1983.

[52] U.S. Cl. D6/381; D6/378

[58] Field of Search D6/335, 337, 371, 379, D6/380, 381, 378; 297/232, 233, 445

[56] References Cited

U.S. PATENT DOCUMENTS

D. 240,311	6/1976	Owens	D6/375
D. 244,894	7/1977	Tillberg	D6/381
D. 245,951	10/1977	Lande	D6/336
D. 246,811	1/1978	Klein et al.	D6/375
4,092,049	5/1978	Schloblom	297/440
4,232,899	11/1980	Fister, Jr.	297/229

OTHER PUBLICATIONS

Interiors, Jun. 1980, p. 44, bottom center, Chair in panel 8.

Interiors, May 1978, p. 27, Seating Unit right center by JG.

Newspaper advertisement printed in the Grand Rapids Press, Apr. 3, 1983.

Vecta Contract Brochure, Tappo Seating, Miko Seating, Wilkhahn 84 Series.

Primary Examiner—Bruce W. Dunkins

Attorney, Agent, or Firm—Price, Heneveld, Cooper, DeWitt & Litton

[57] CLAIM

The ornamental design for a sofa, as shown and described.

DESCRIPTION

FIG. 1 is a front perspective view of a sofa showing my design;

FIG. 2 is a rear perspective view;

FIG. 3 is a top plan view;

FIG. 4 is a front elevational view;

FIG. 5 is a rear elevational view; and

FIG. 6 is a side elevational view thereof;

FIG. 7 is a front perspective view of a sofa showing a second embodiment of my design; and

FIG. 8 is a rear perspective view thereof.

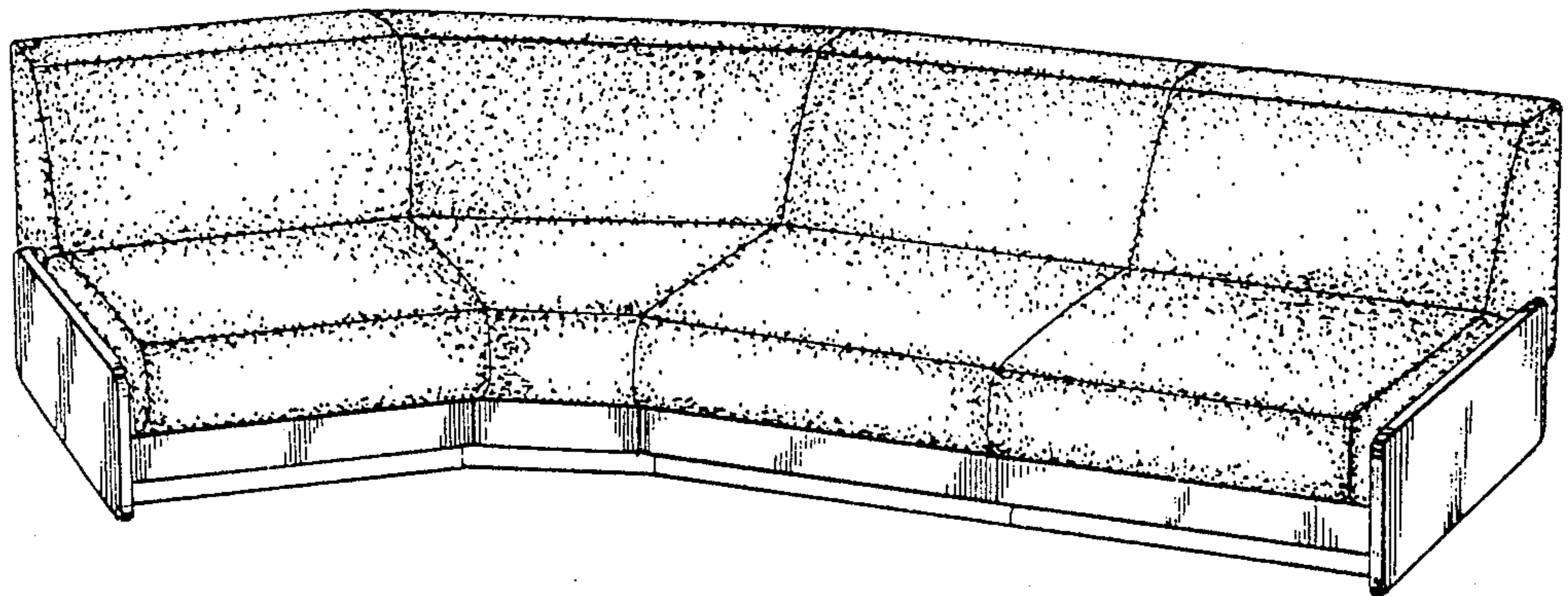

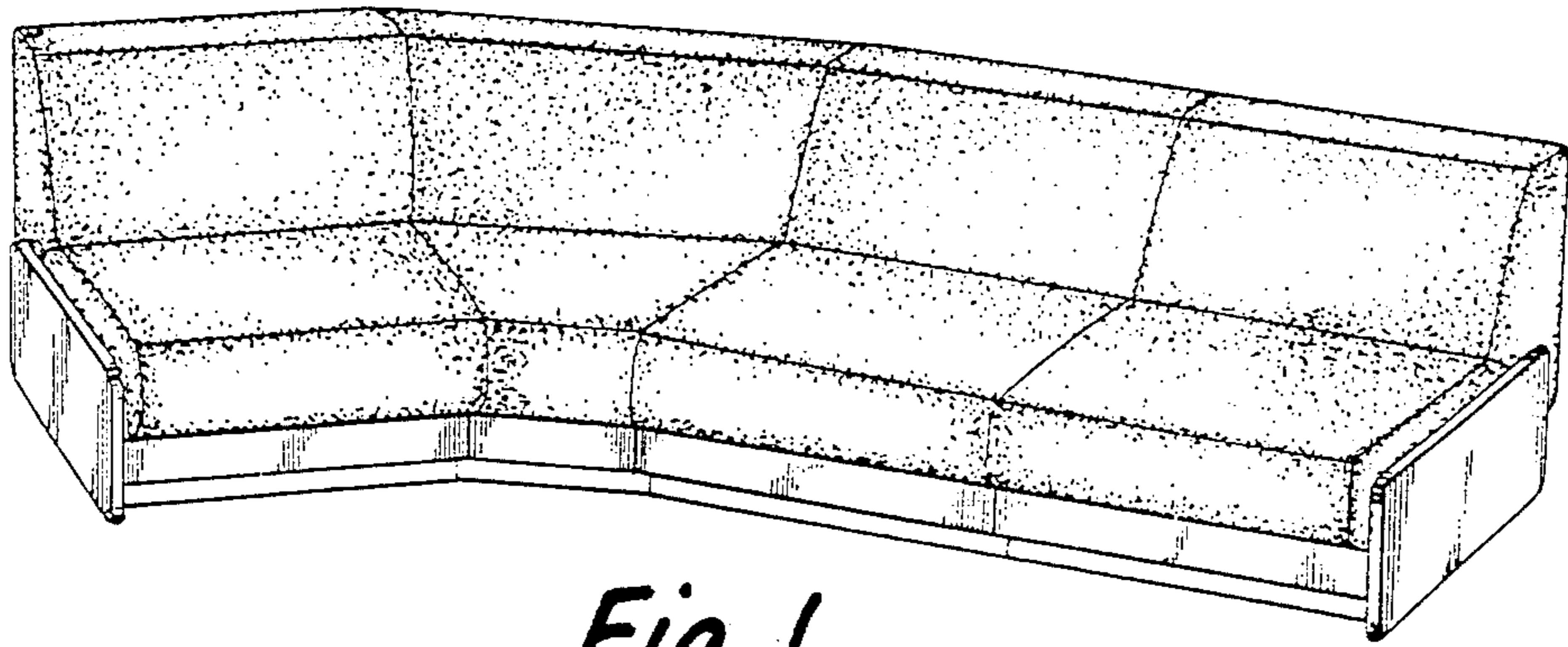

Fig. 1

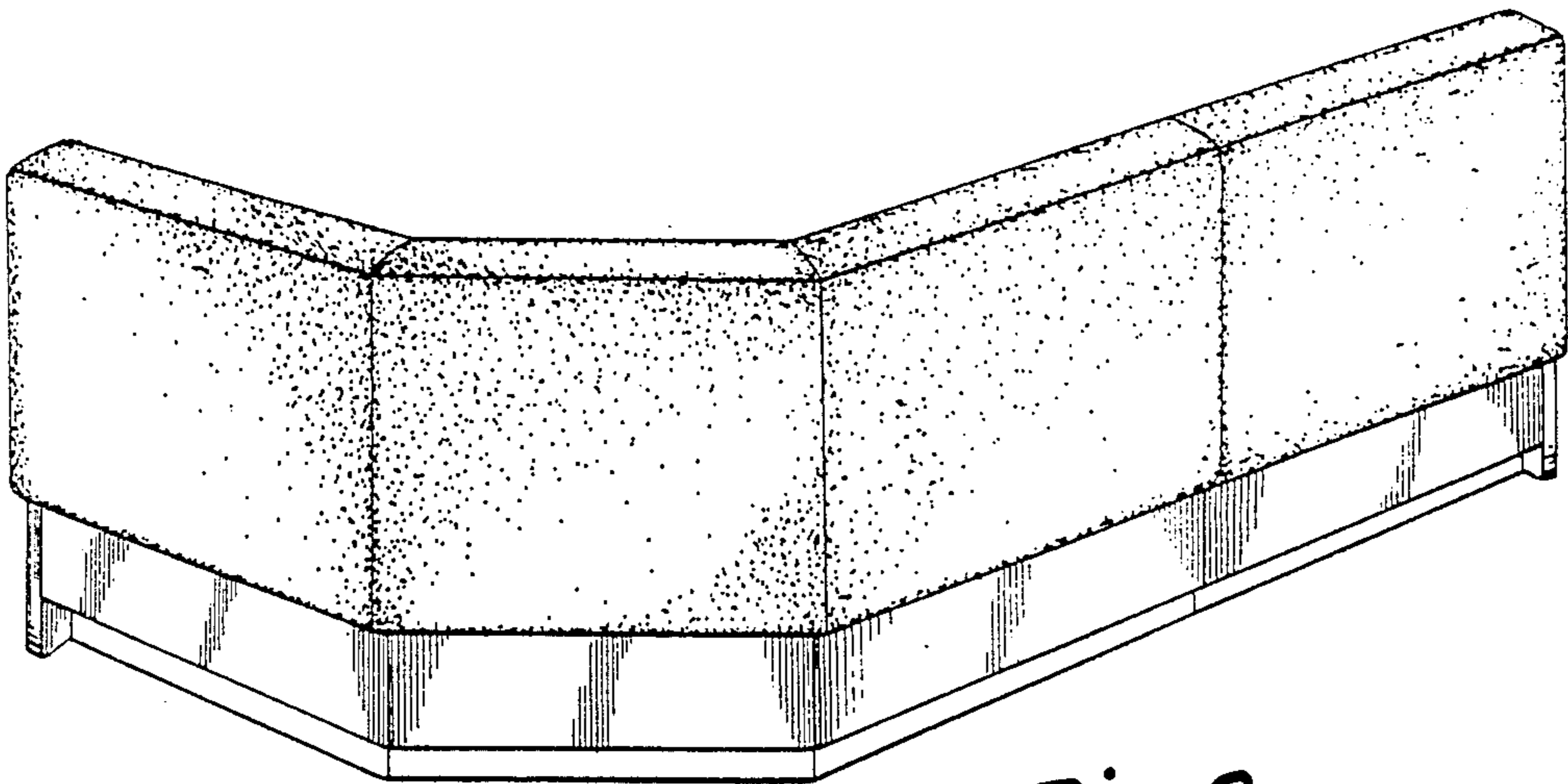

Fig. 2

Fig. 3.

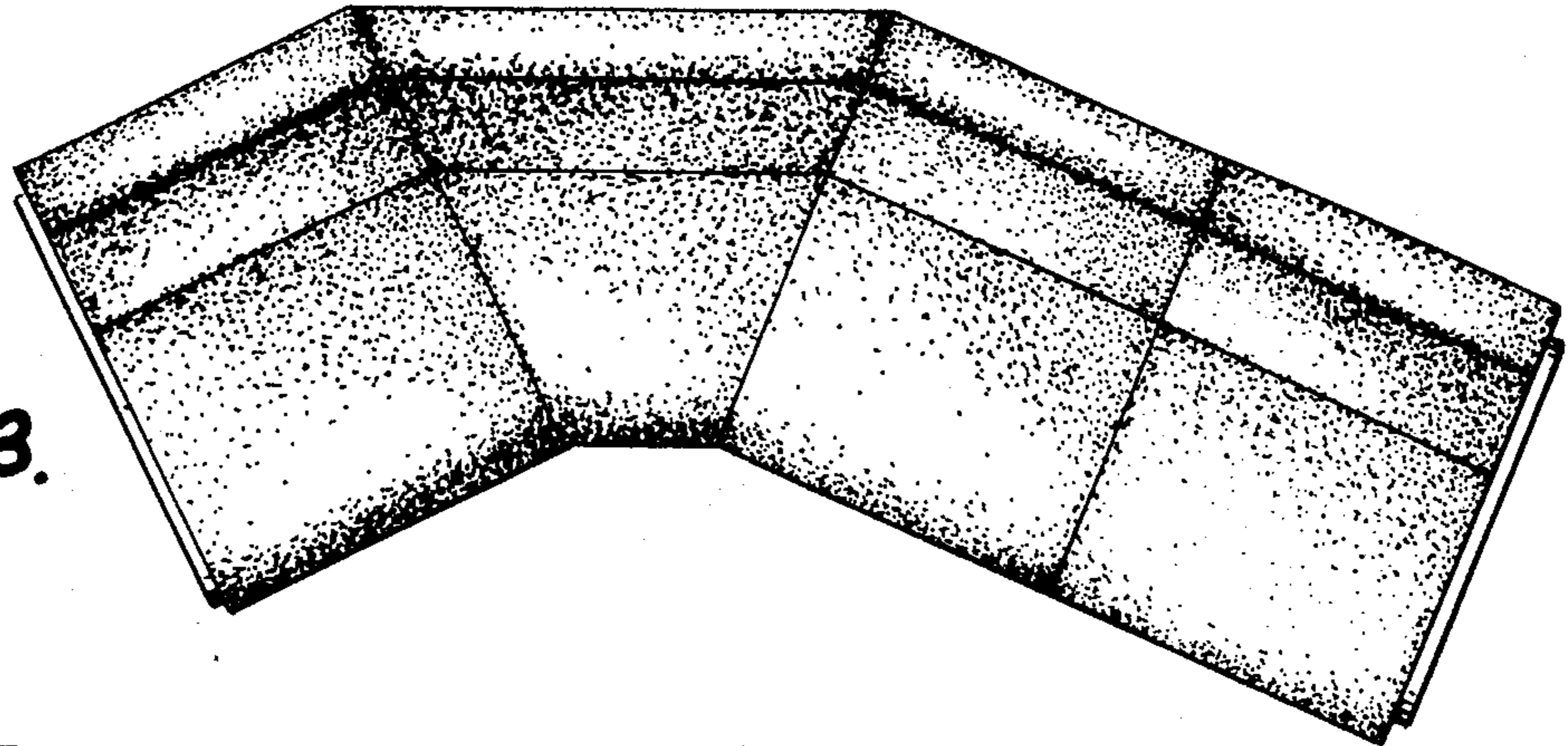

Fig. 4.

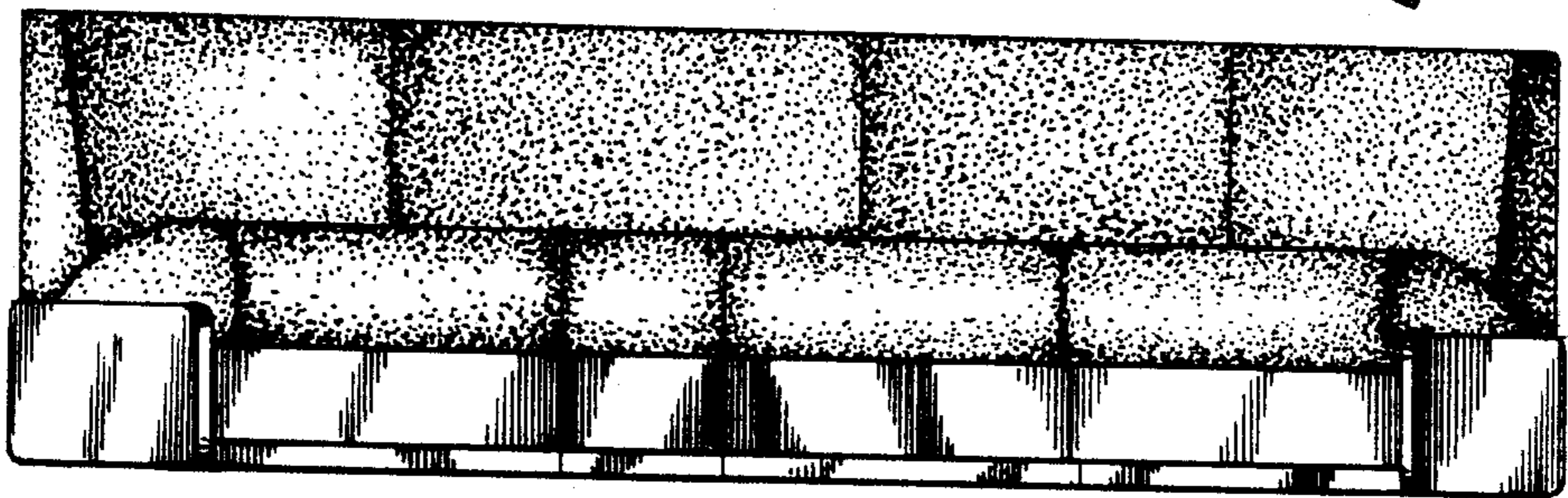

Fig. 5.

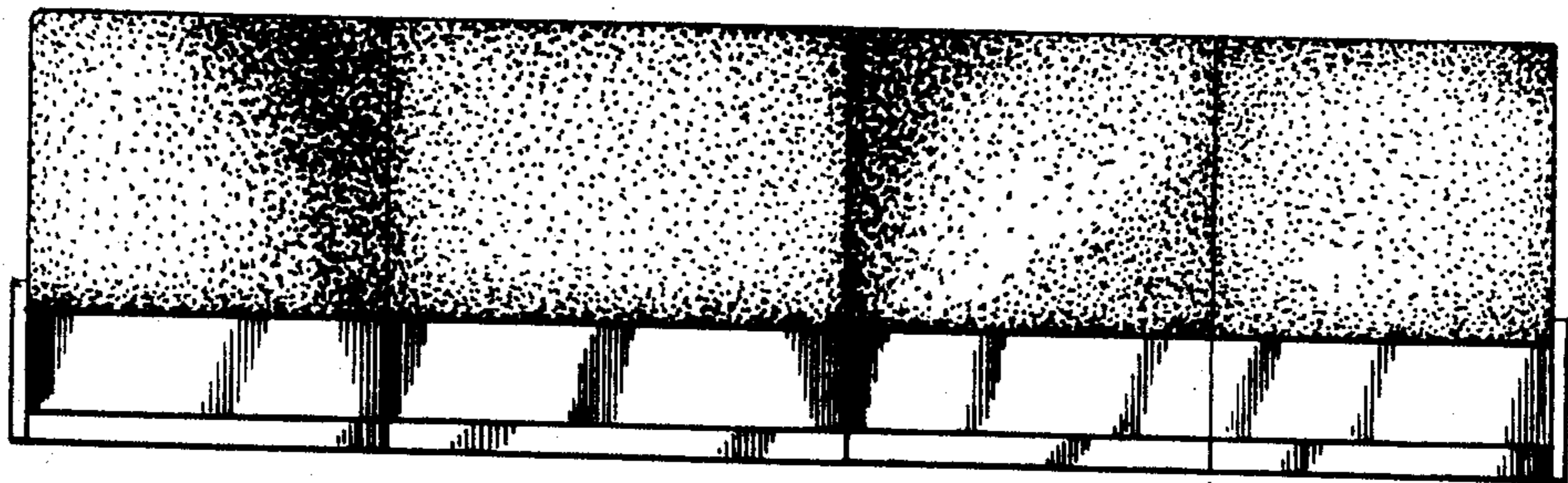
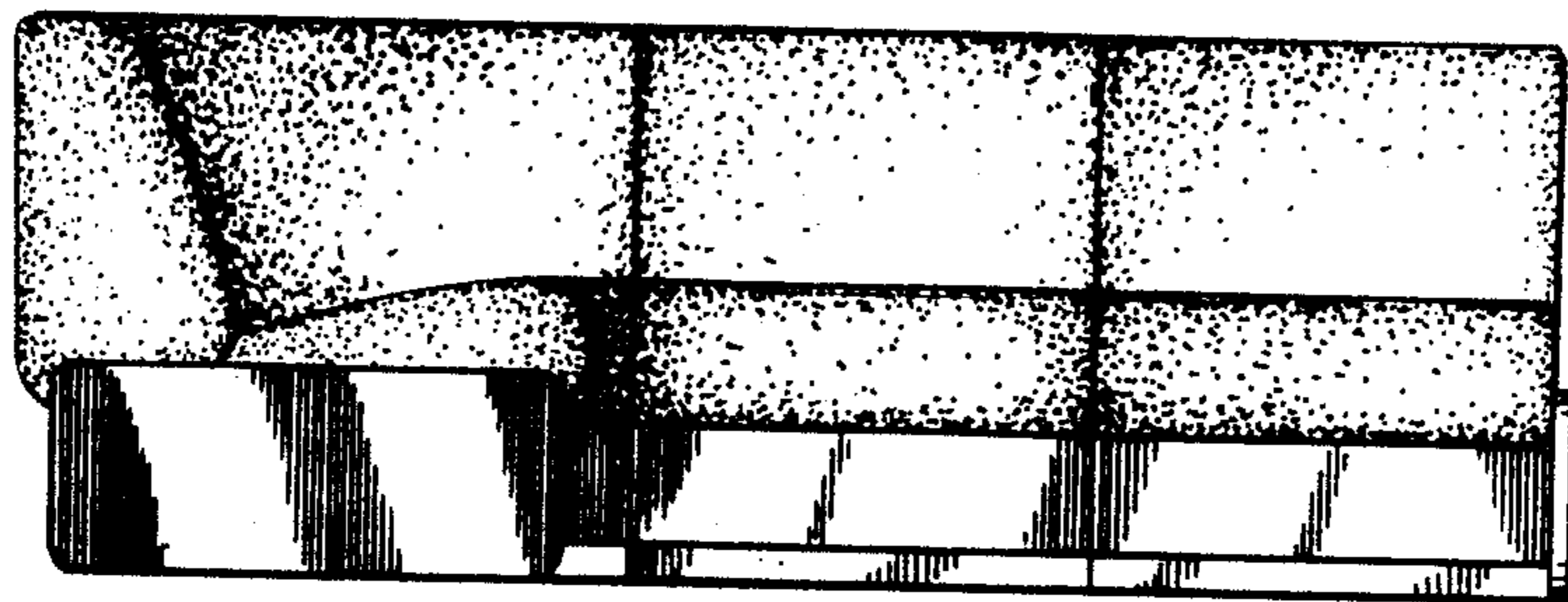

Fig. 6.



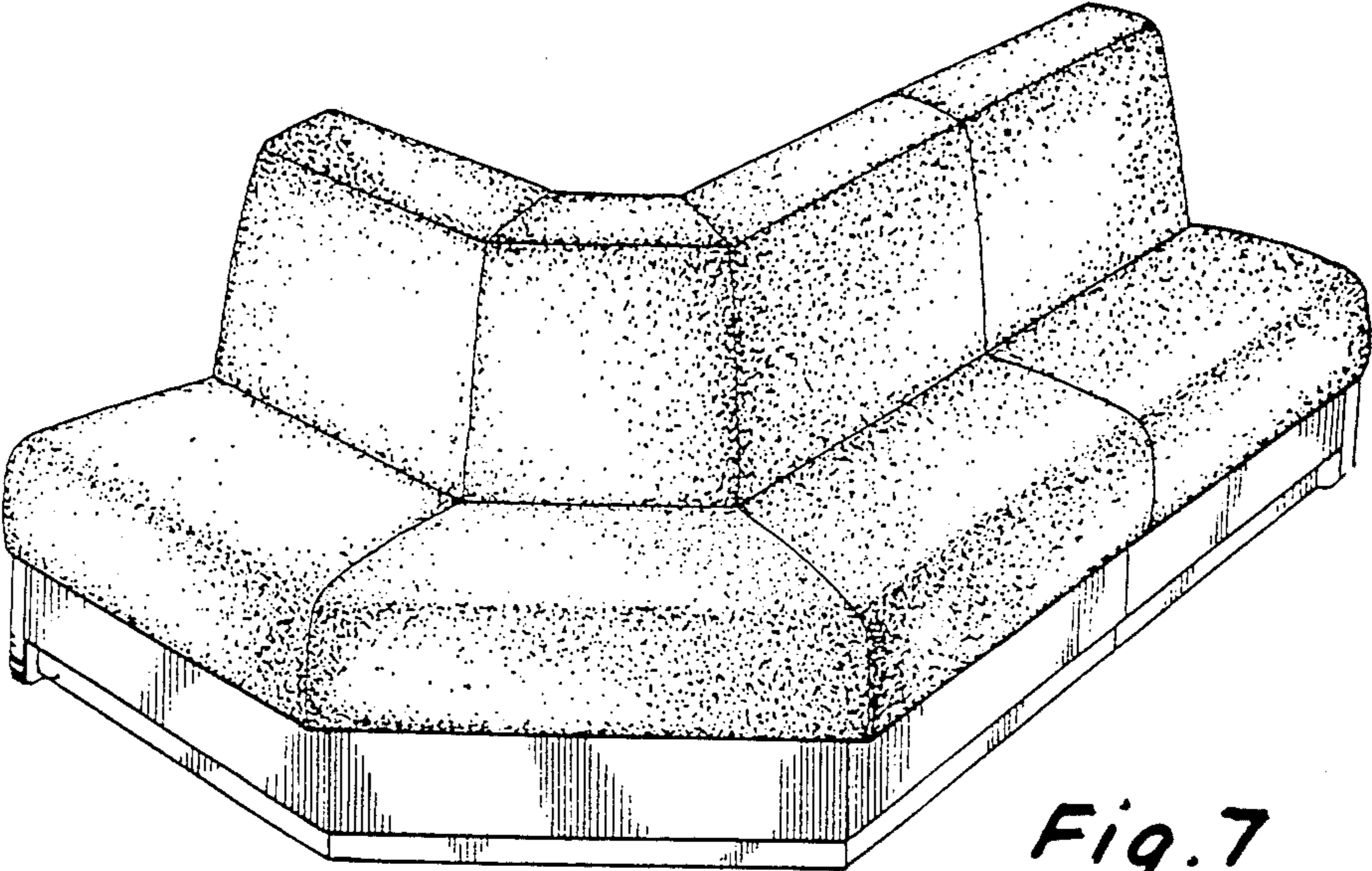

Fig. 7

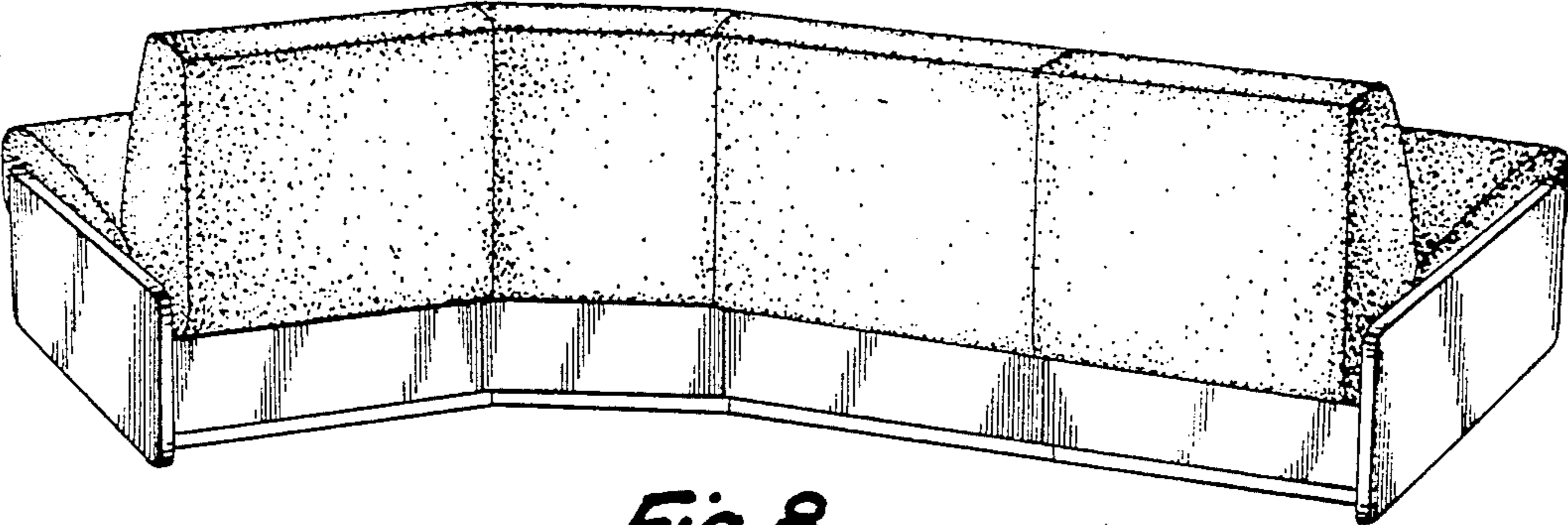

Fig. 8