

[54] ARMREST FOR A CHAIR

[75] Inventor: Burkhard Vogtherr, Kandern-Holzen, Fed. Rep. of Germany

[73] Assignee: Klöber GmbH & Co., Fed. Rep. of Germany

[**] Term: 14 Years

[21] Appl. No.: 621,612

[22] Filed: Jun. 18, 1984

[52] U.S. Cl. D6/500; D6/366

[58] Field of Search D6/334, 364, 365, 366, D6/370-379

[56] References Cited

U.S. PATENT DOCUMENTS

D. 145,918	11/1946	Armstrong	D6/344
D. 261,958	11/1981	Dowse	D6/375
D. 281,935	12/1985	Lowsky	D6/373
4,073,539	2/1978	Caruso	D6/366 X

Primary Examiner—Bruce W. Dunkins
Attorney, Agent, or Firm—Hill, Van Santen, Steadman & Simpson

[57] CLAIM

The ornamental design for an armrest for a chair, as shown and described.

DESCRIPTION

FIG. 1 is a side perspective view of an arm rest for a chair showing my design;
FIG. 2 is a front elevational view of the armrest of FIG. 1;
FIG. 3 is a rear elevational view of the armrest of FIG. 1;
FIG. 4 is a side elevational view of the armrest of FIG. 1 taken from a side opposite to the side illustrated in FIG. 1;
FIG. 5 is a top plan view of the armrest of FIG. 4; and
FIG. 6 is a bottom plan view of the arm rests of FIG. 4.
The broken lines depicting a chair in FIG. 1 have been shown for illustrative purposes only.

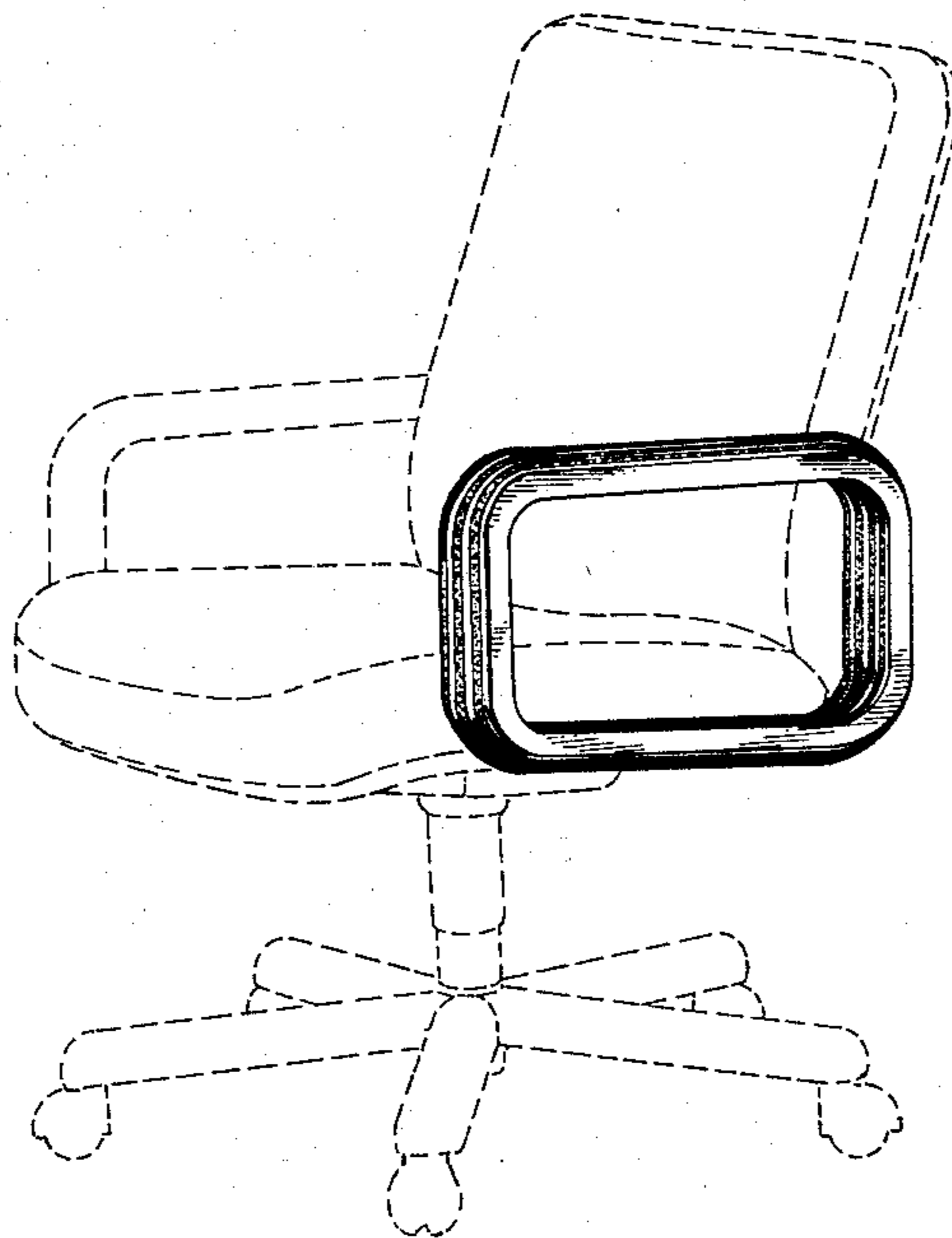

FIG. 1

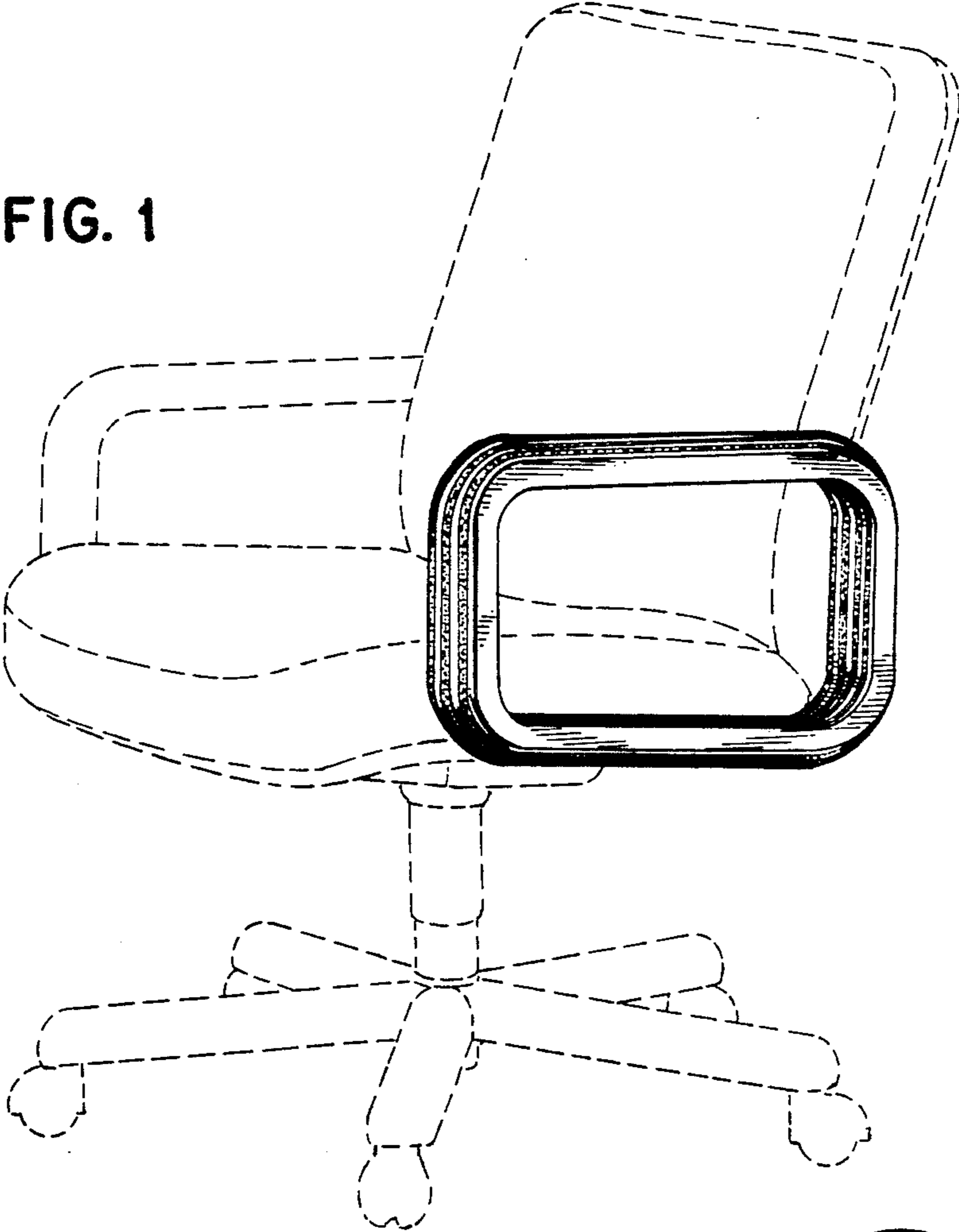

FIG. 2

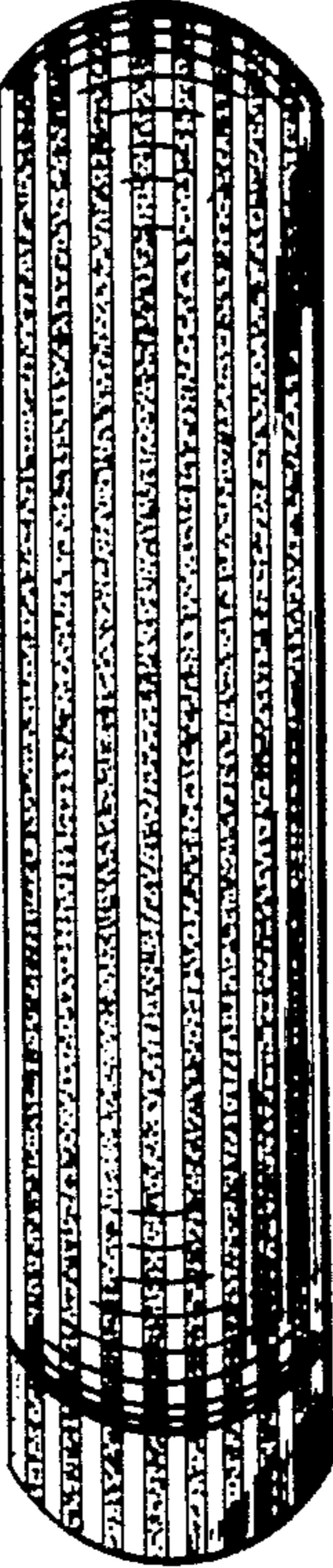
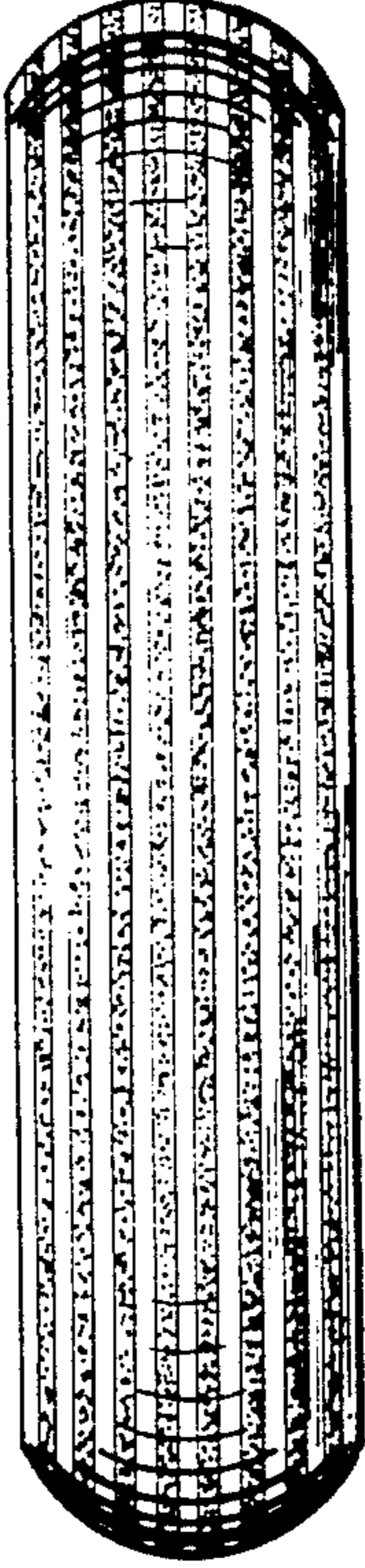

FIG. 3



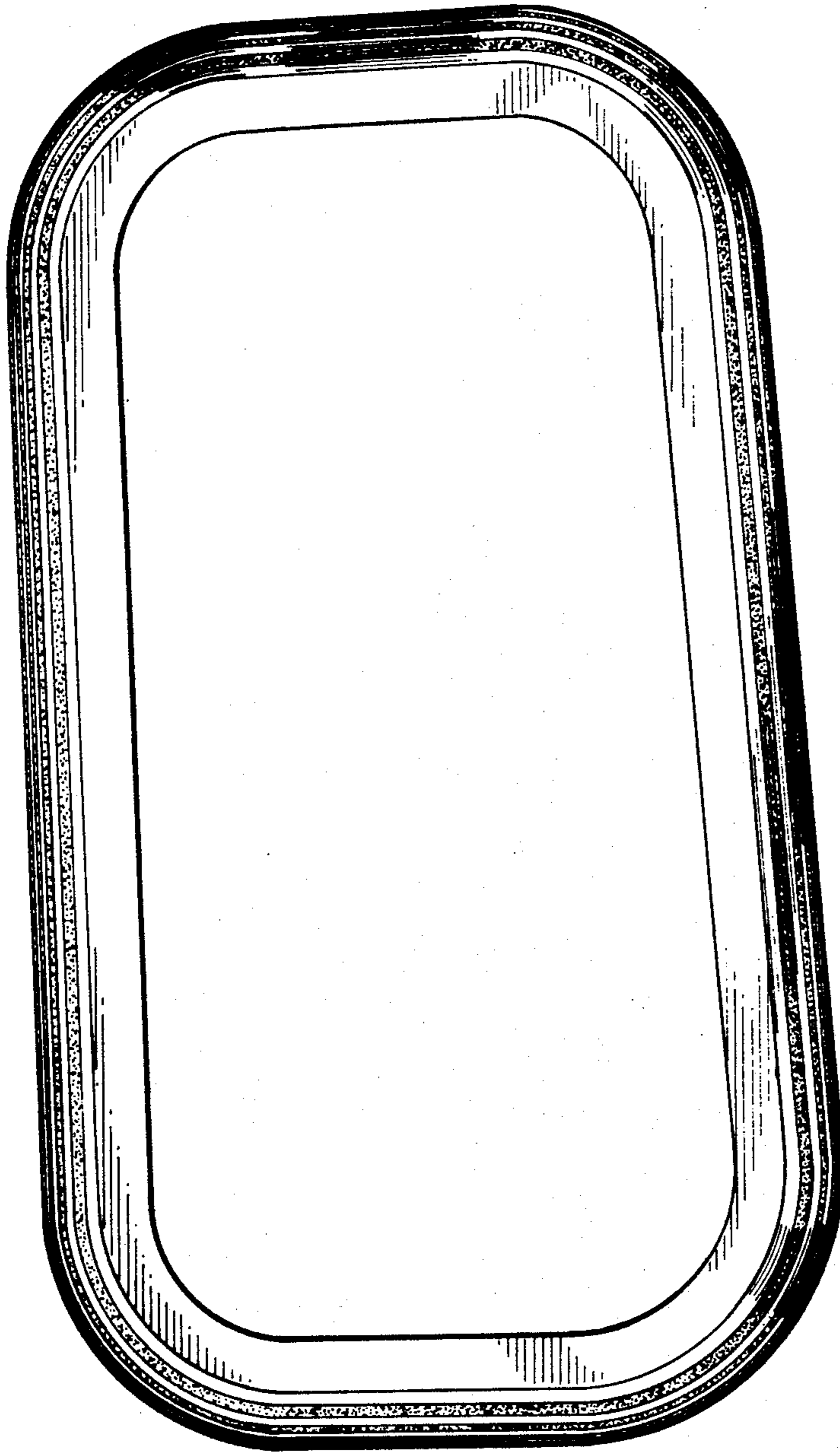

FIG. 4

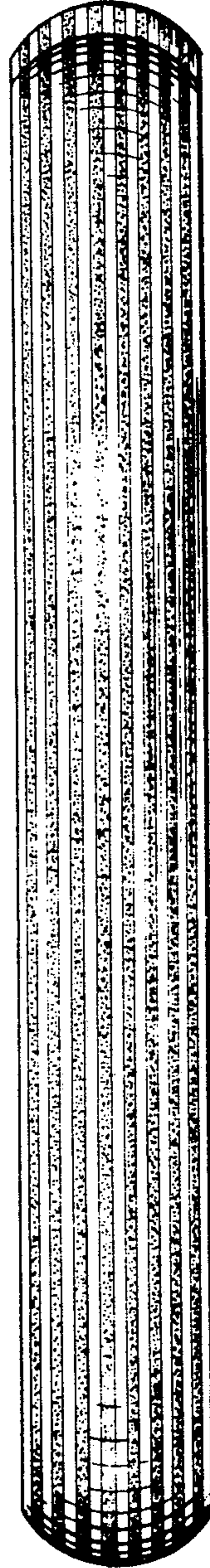

FIG. 5

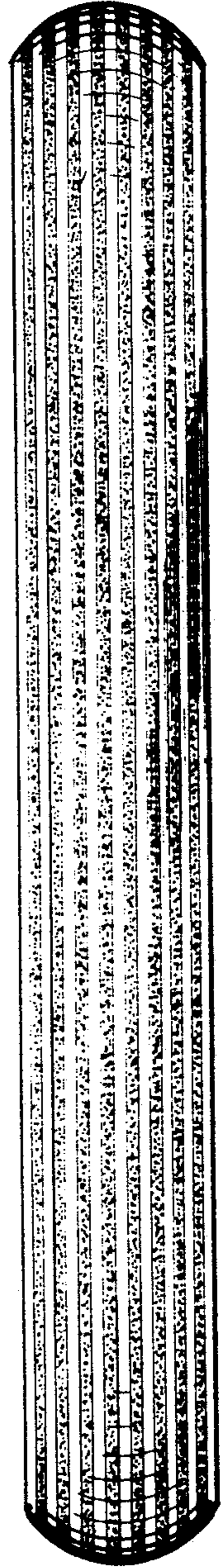

FIG. 6