

- [54] EAVESTROUGH HANGER BRACKET
- [75] Inventor: James Skinner, Mississauga, Canada
- [73] Assignee: Daymond, Division of Redpath Industries Limited, Mississauga, Canada
- [**] Term: 14 Years
- [21] Appl. No.: 665,997
- [22] Filed: Oct. 29, 1984
- [52] U.S. Cl. D8/381; 248/48.2; D8/373
- [58] Field of Search 248/235, 247, 248, 48.1, 248/48.2; 211/90, 123; D8/373, 380, 381, 371, 367; 405/118, 123

3,296,749	1/1967	Cotter	248/48.2
3,416,760	12/1968	Sander	248/48.2
3,436,878	4/1969	Singer	248/48.2
3,630,473	12/1971	Landis	248/48.2
4,242,548	12/1980	Rowe	248/48.2
4,314,683	2/1982	Cunning	248/48.2

Primary Examiner—Wallace R. Burke
 Assistant Examiner—Horace B. Fay
 Attorney, Agent, or Firm—Ivor M. Hughes

[57] CLAIM

The ornamental design for an eavestrough hanger bracket, as shown and described.

DESCRIPTION

FIG. 1 is a left side, top and front perspective view of an eavestrough hanger bracket showing my new design; FIG. 2 is a side elevational view thereof; FIGS. 3 and 4 are respectively top and bottom plan views thereof; FIGS. 5 and 6 are respectively front and rear elevational views thereof.

[56] References Cited

U.S. PATENT DOCUMENTS

1,855,241	4/1932	Irwin	248/48.2
3,022,029	2/1962	Blayden	248/48.2
3,053,491	9/1962	Ramser	248/48.2

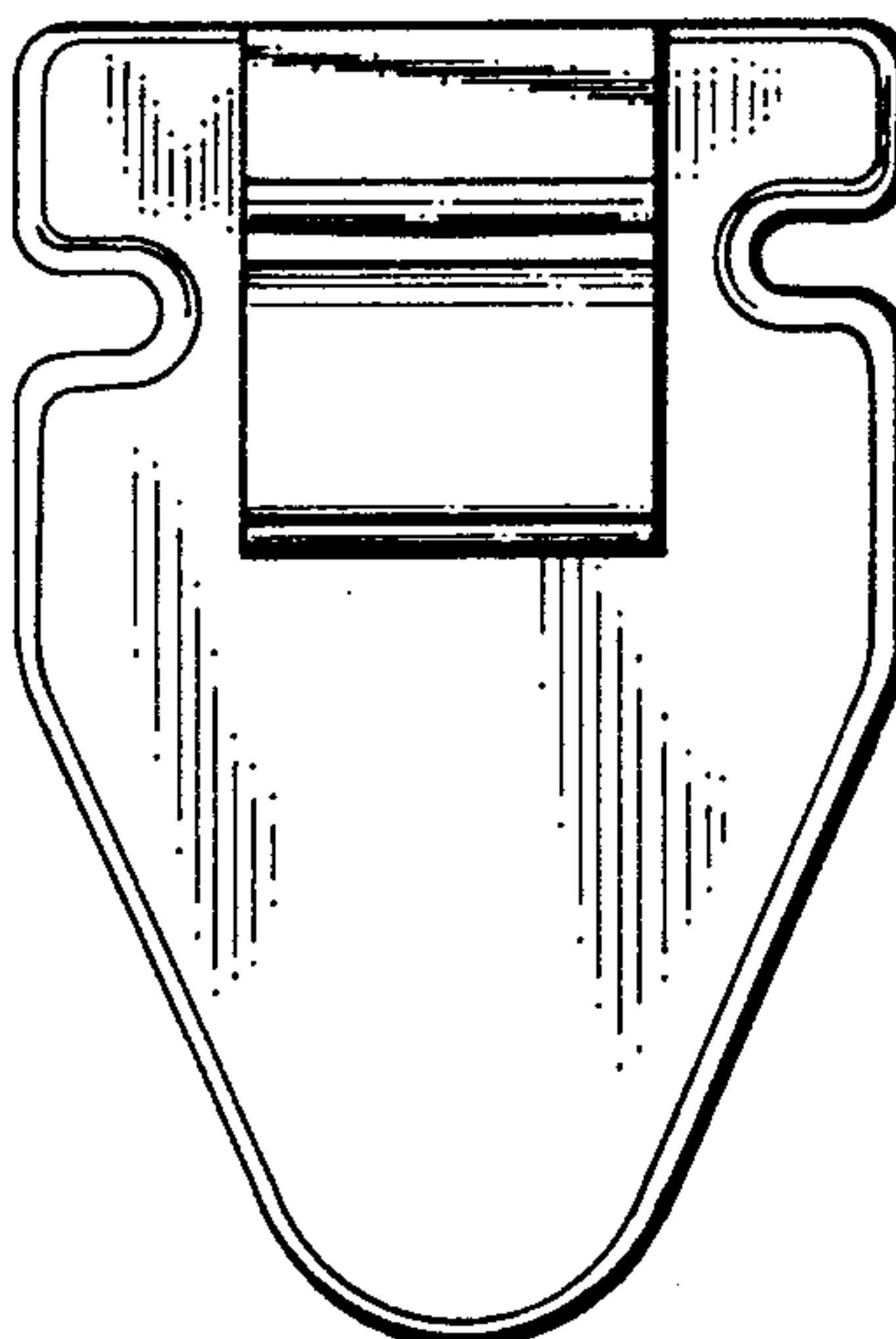
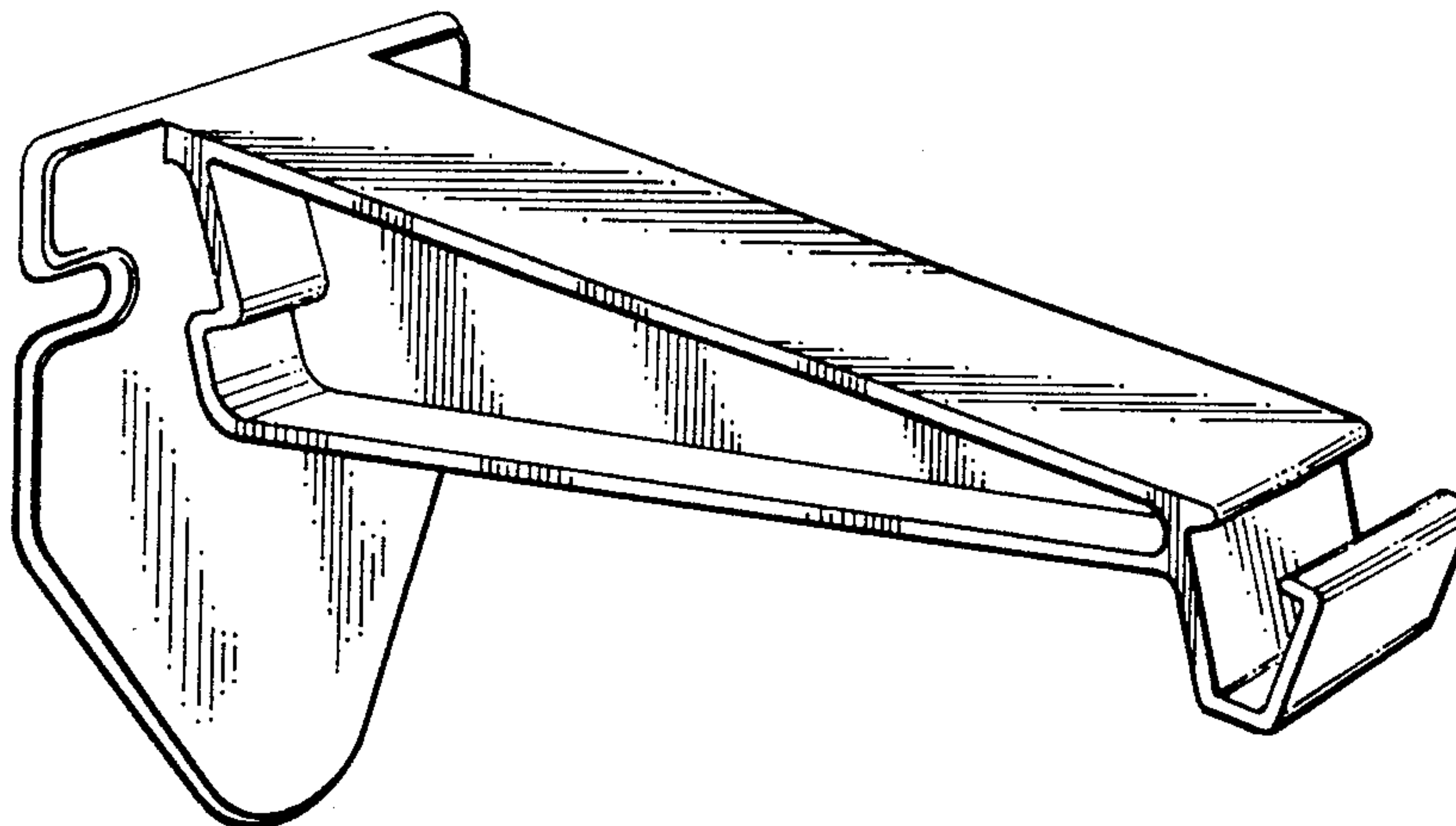

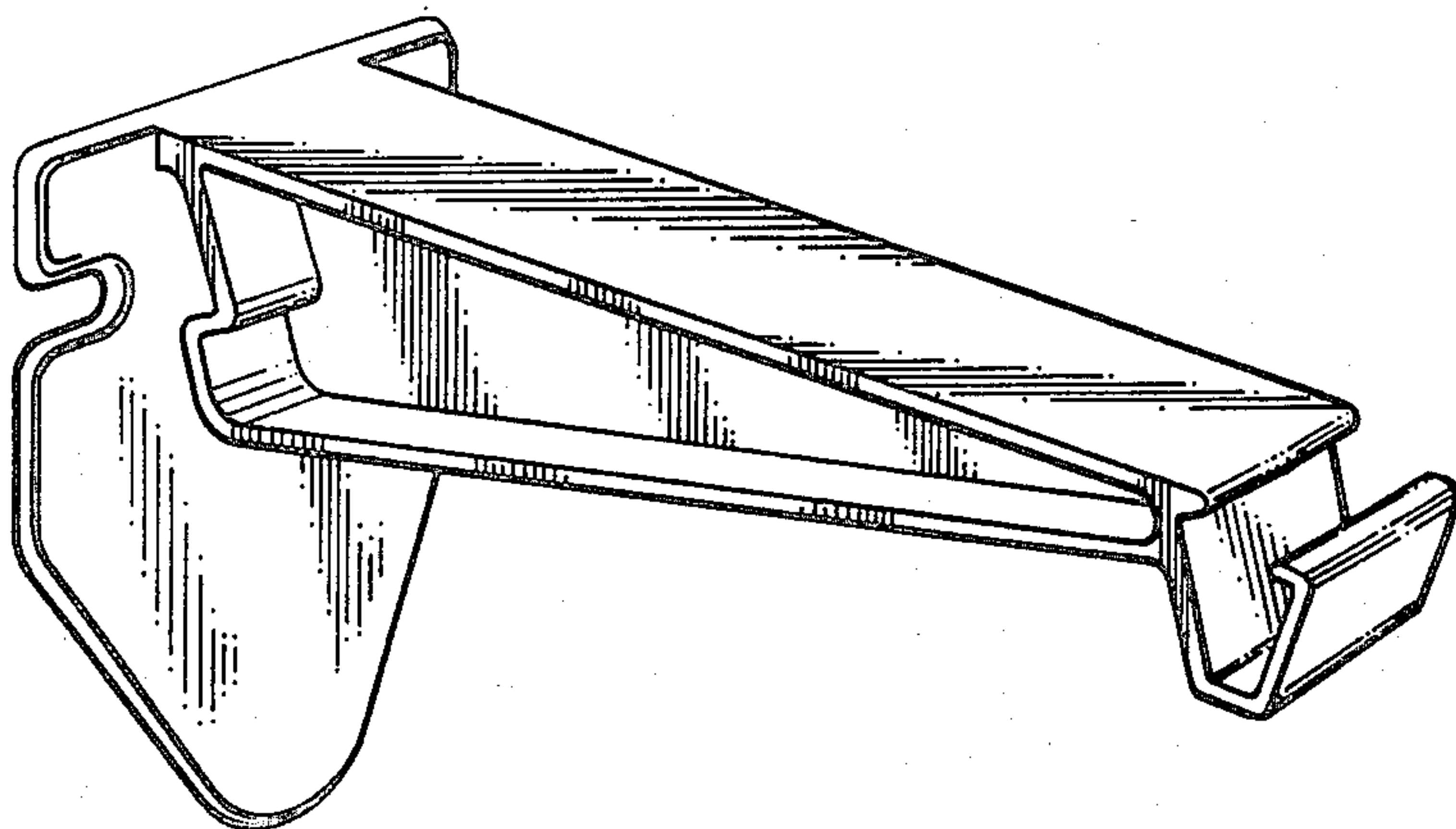

FIG. 1.

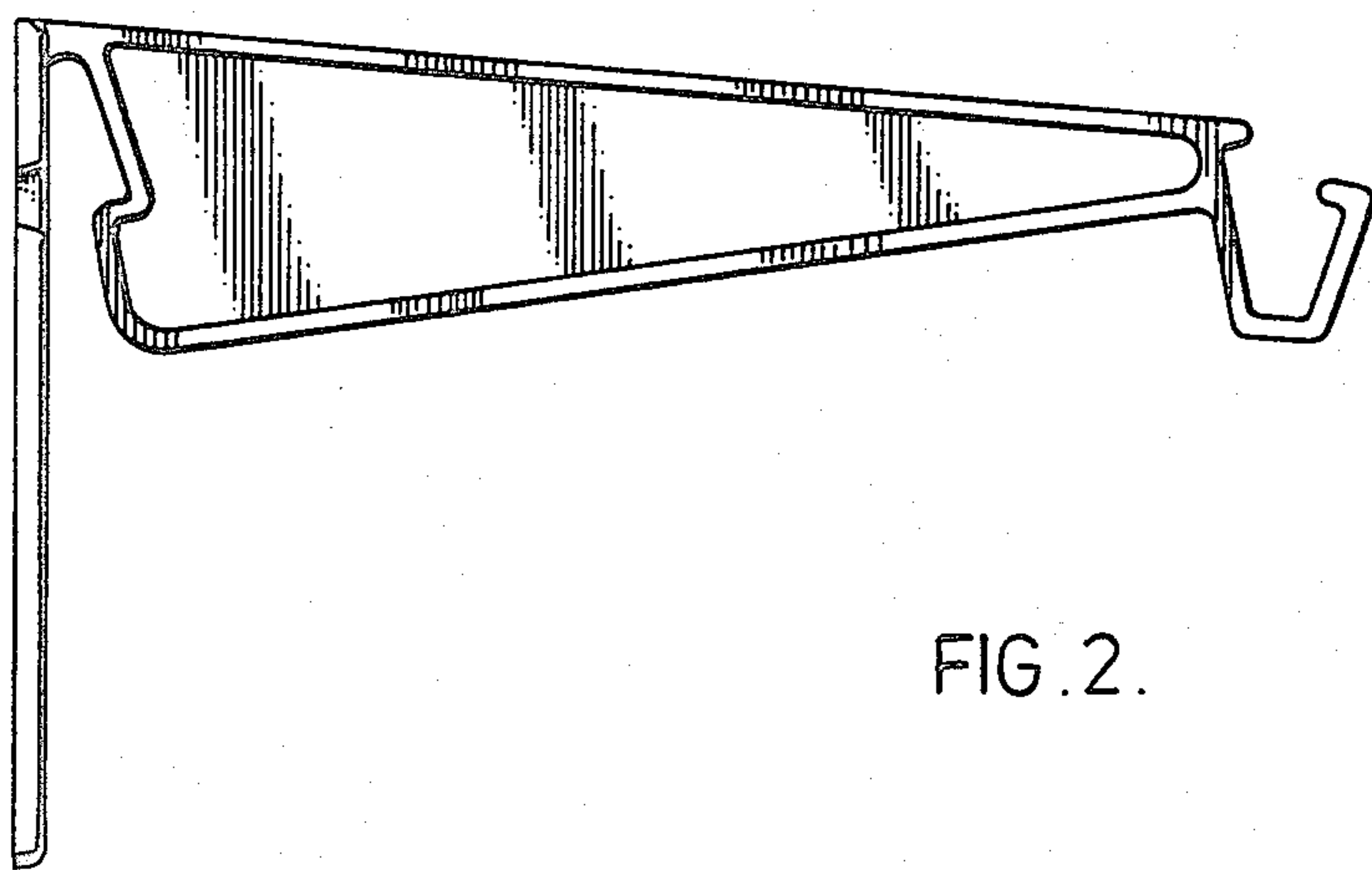

FIG. 2.

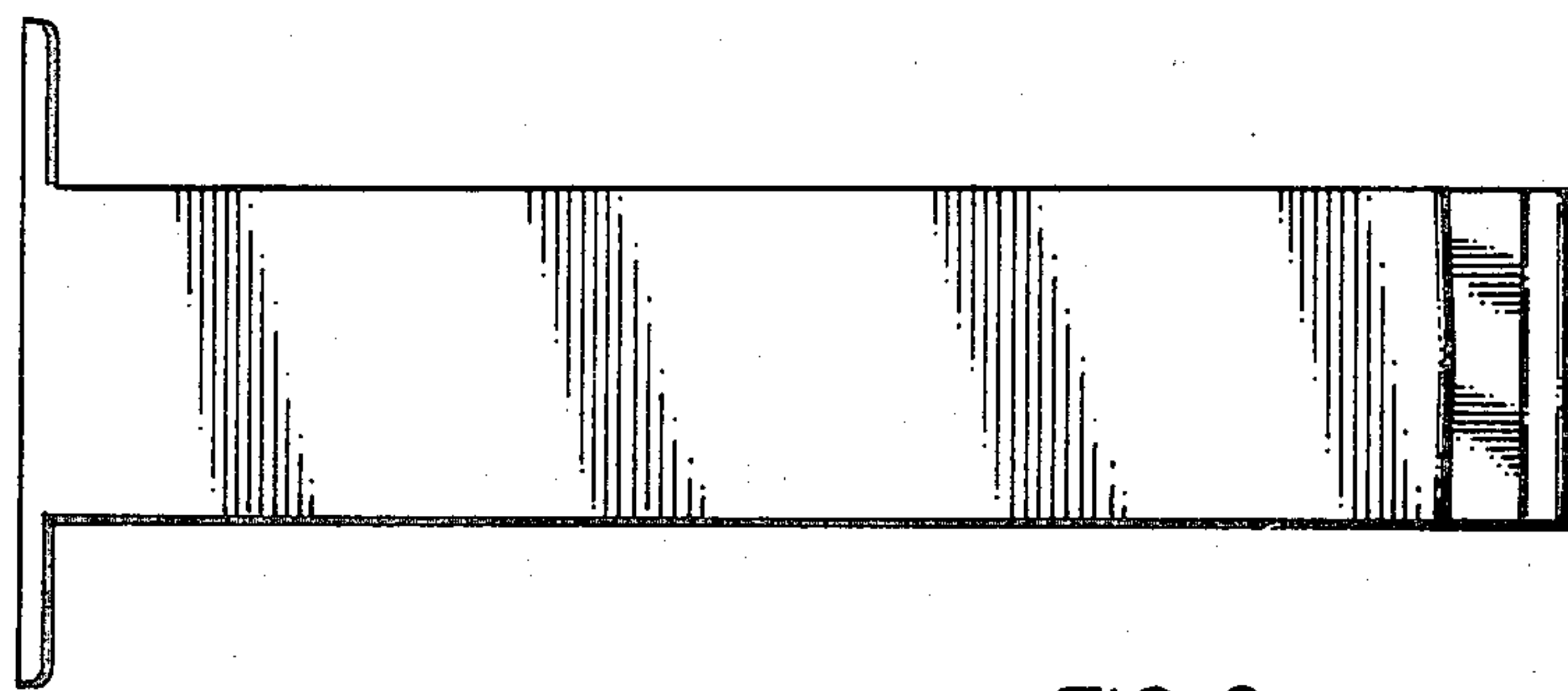

FIG. 3.

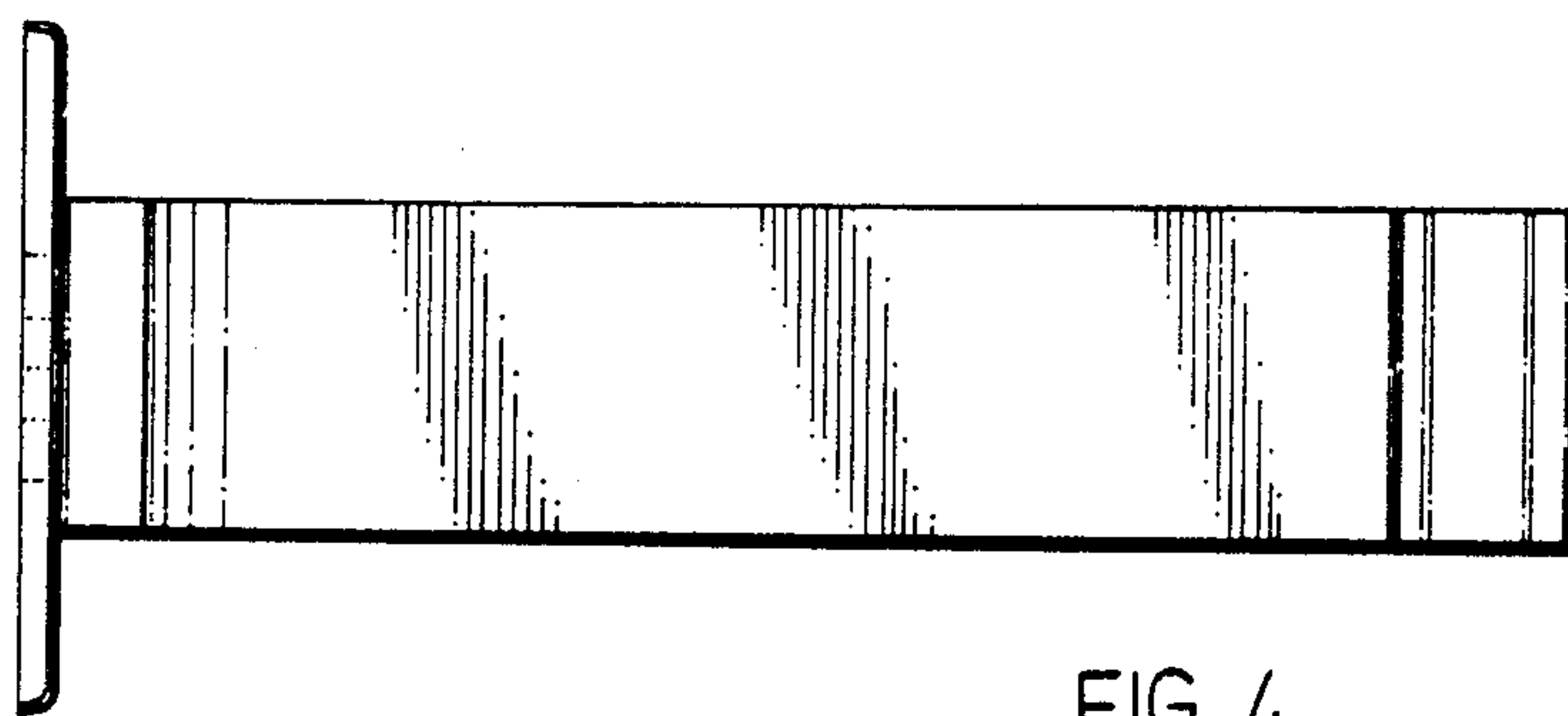

FIG. 4.

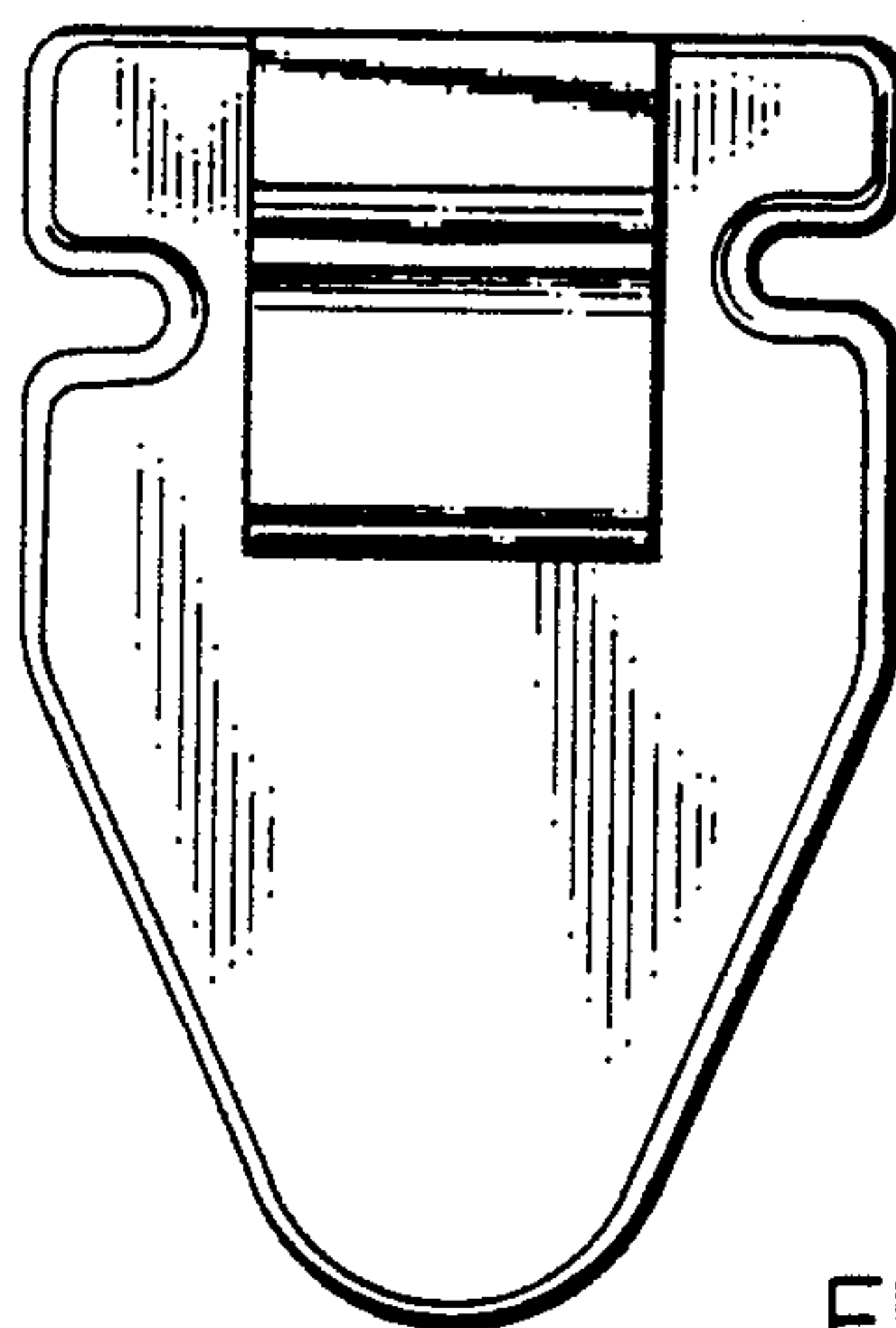

FIG. 5.

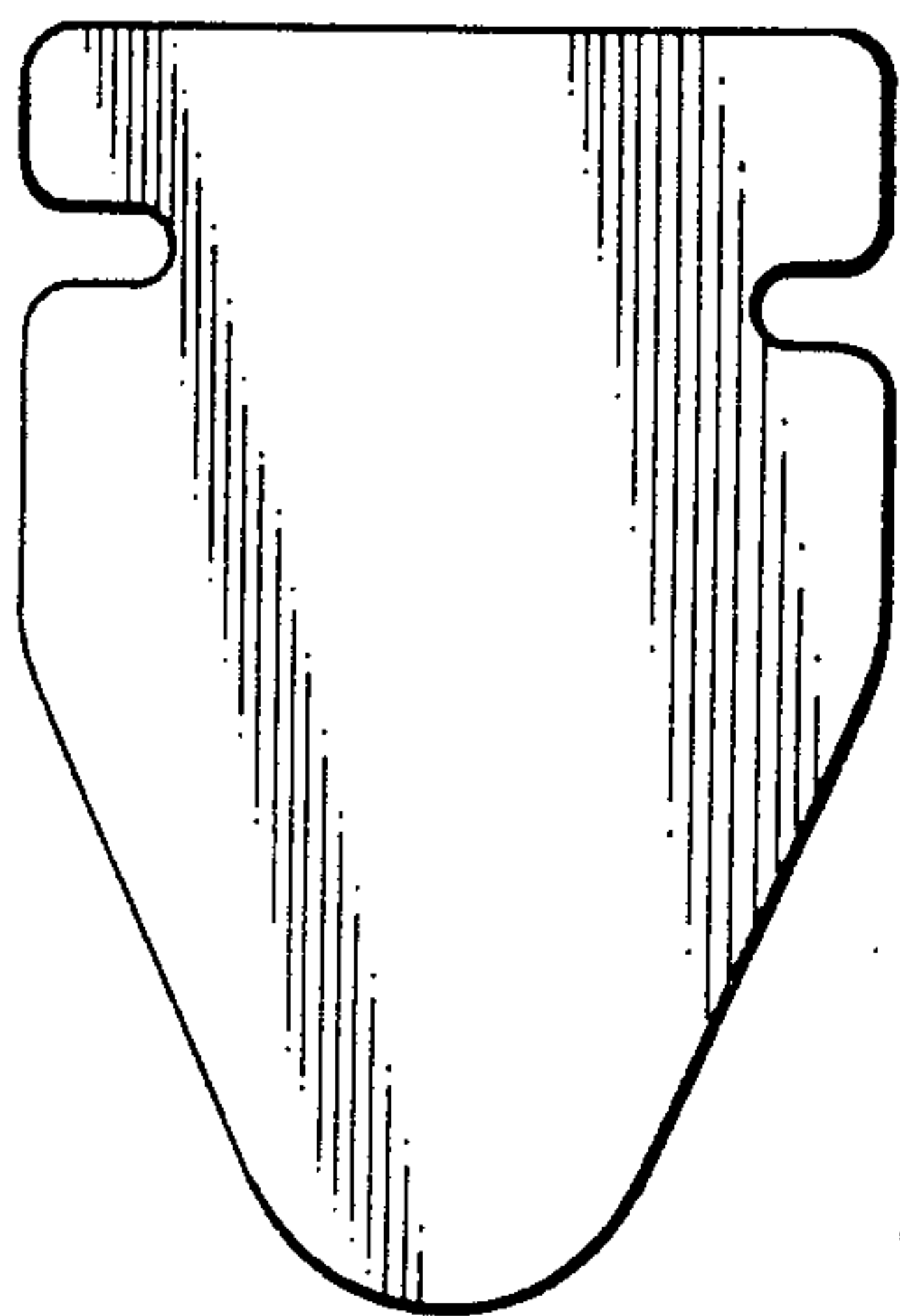

FIG. 6.