

[54] TAPE PLAYER

[75] Inventors: Jyoji Kukita, Gunma; Naoki Tsukamoto, Saitama; Shin-ichi Morinaga, Musashino, all of Japan

[73] Assignee: Sanyo Electric Co., Ltd, Japan

[**] Term: 14 Years

[21] Appl. No.: 678,663

[22] Filed: Dec. 6, 1984

[30] Foreign Application Priority Data

Jun. 6, 1984 [JP] Japan 59-23219

[52] U.S. Cl. D14/6; D14/5; D14/68

[58] Field of Search D14/1, 2, 3, 5, 6, 68, D14/70, 99; 360/99

[56] References Cited

U.S. PATENT DOCUMENTS

D. 270,908 10/1983 Sumita D14/6

D. 273,380 4/1984 Takenaka D14/5

D. 277,564 2/1985 Ohno et al. D14/5

D. 277,565 2/1985 Murakami et al. D14/5

D. 284,765 7/1986 Lam D14/70

OTHER PUBLICATIONS

Merchandising, Jan. 1983, p. 80, Sanyo Sportster MG100.

Primary Examiner—Bernard Ansher
Assistant Examiner—Theodore M. Shooman
Attorney, Agent, or Firm—Darby & Darby

[57] CLAIM

The ornamental design for a tape player, as shown.

DESCRIPTION

FIG. 1 is a front elevational view of a tape player showing our new design;
FIG. 2 is a right side elevational view thereof;
FIG. 3 is a top plan view thereof;
FIG. 4 is a bottom plan view thereof;
FIG. 5 is a rear elevational view thereof;
FIG. 6 is a left side elevational view thereof; and
FIG. 7 is a top, front and right side perspective view thereof.

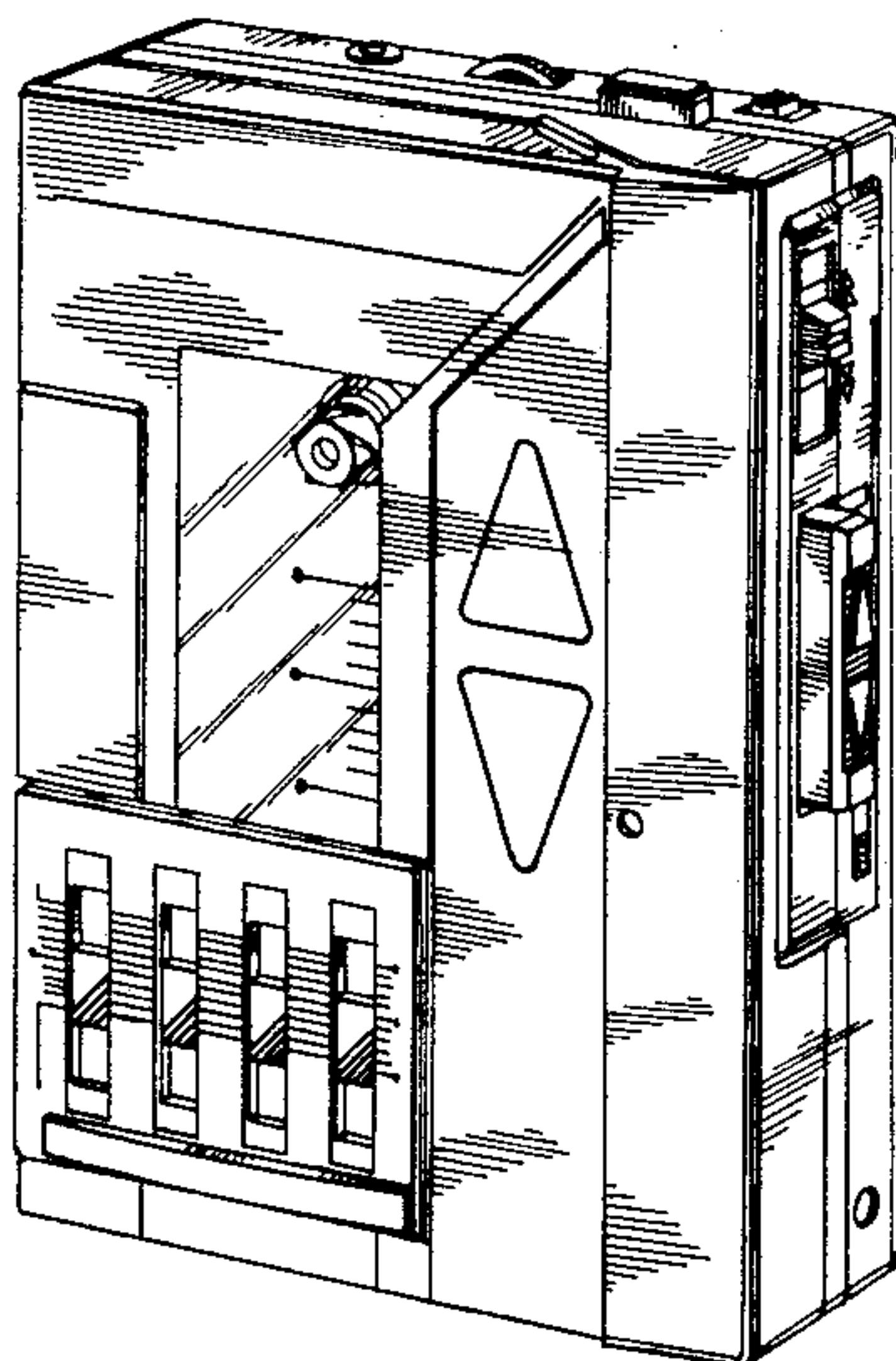

FIG. 1

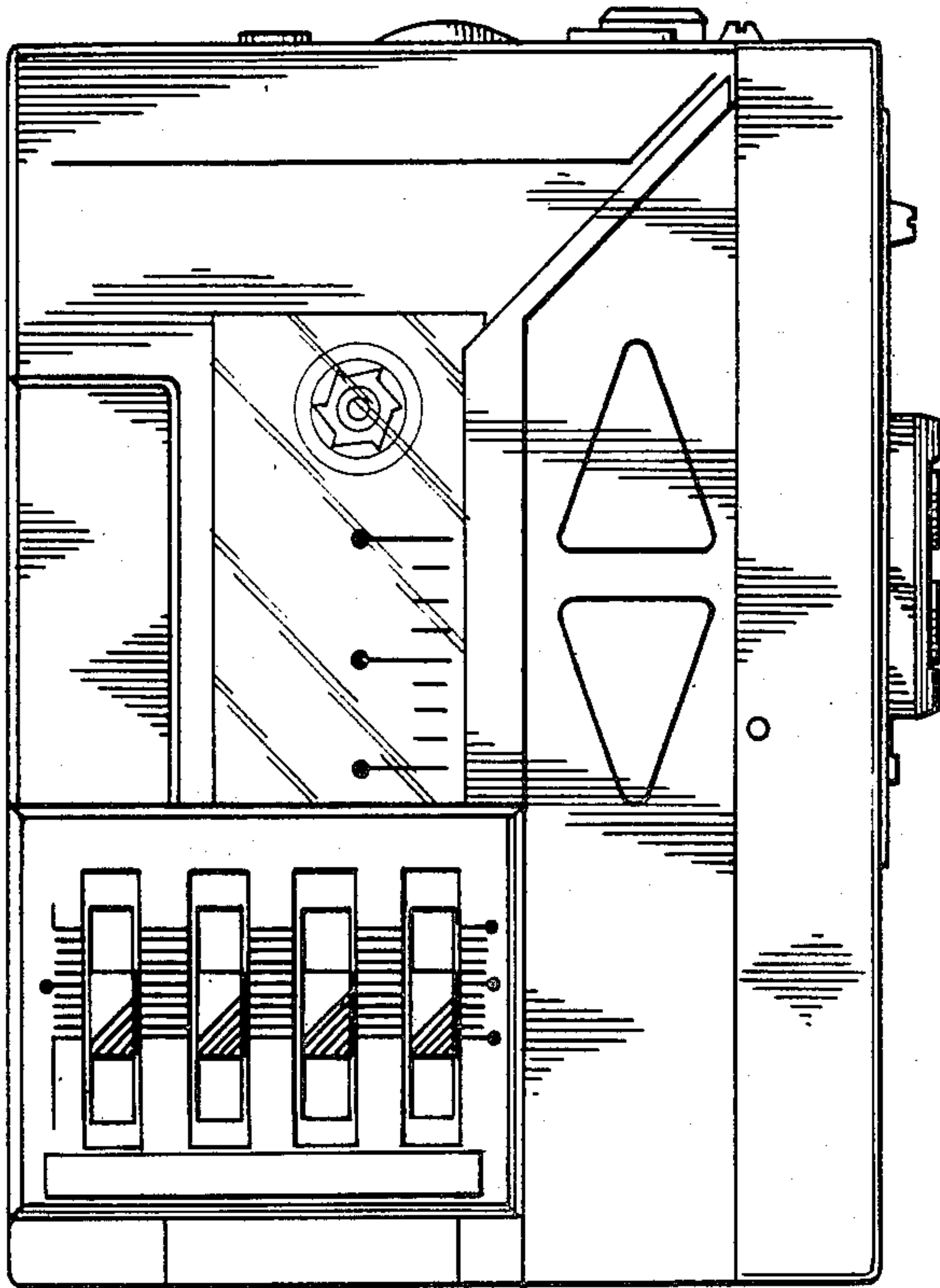

FIG. 2

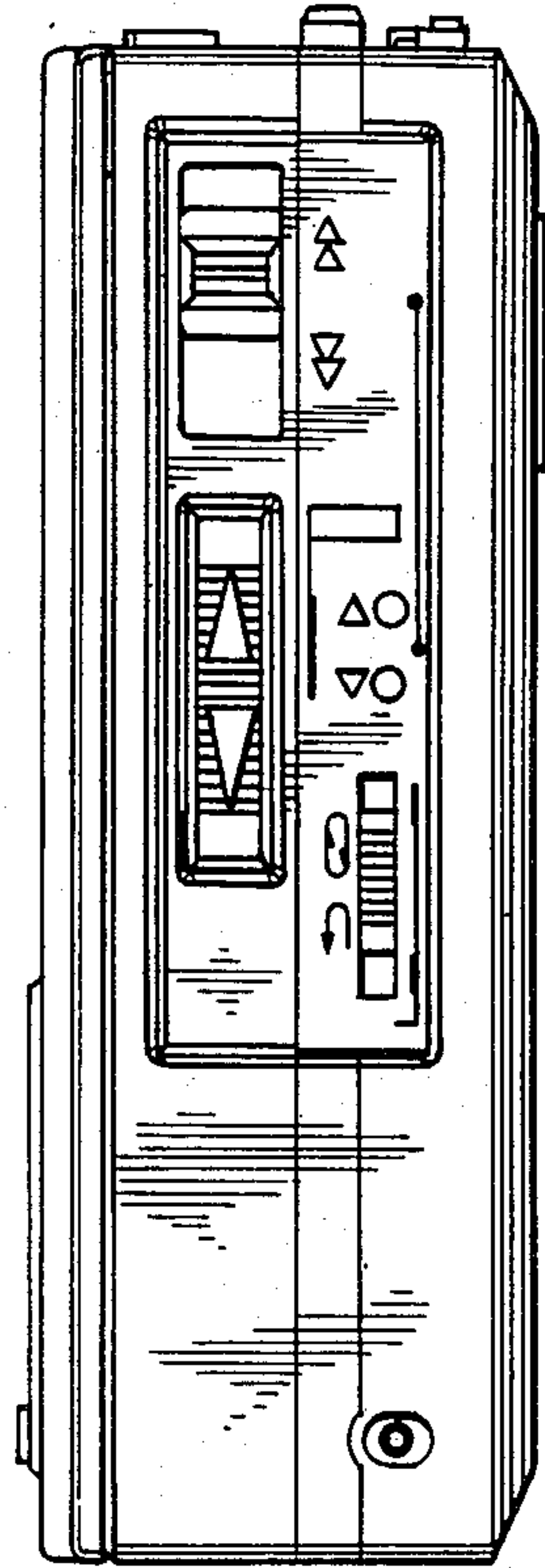

FIG. 3

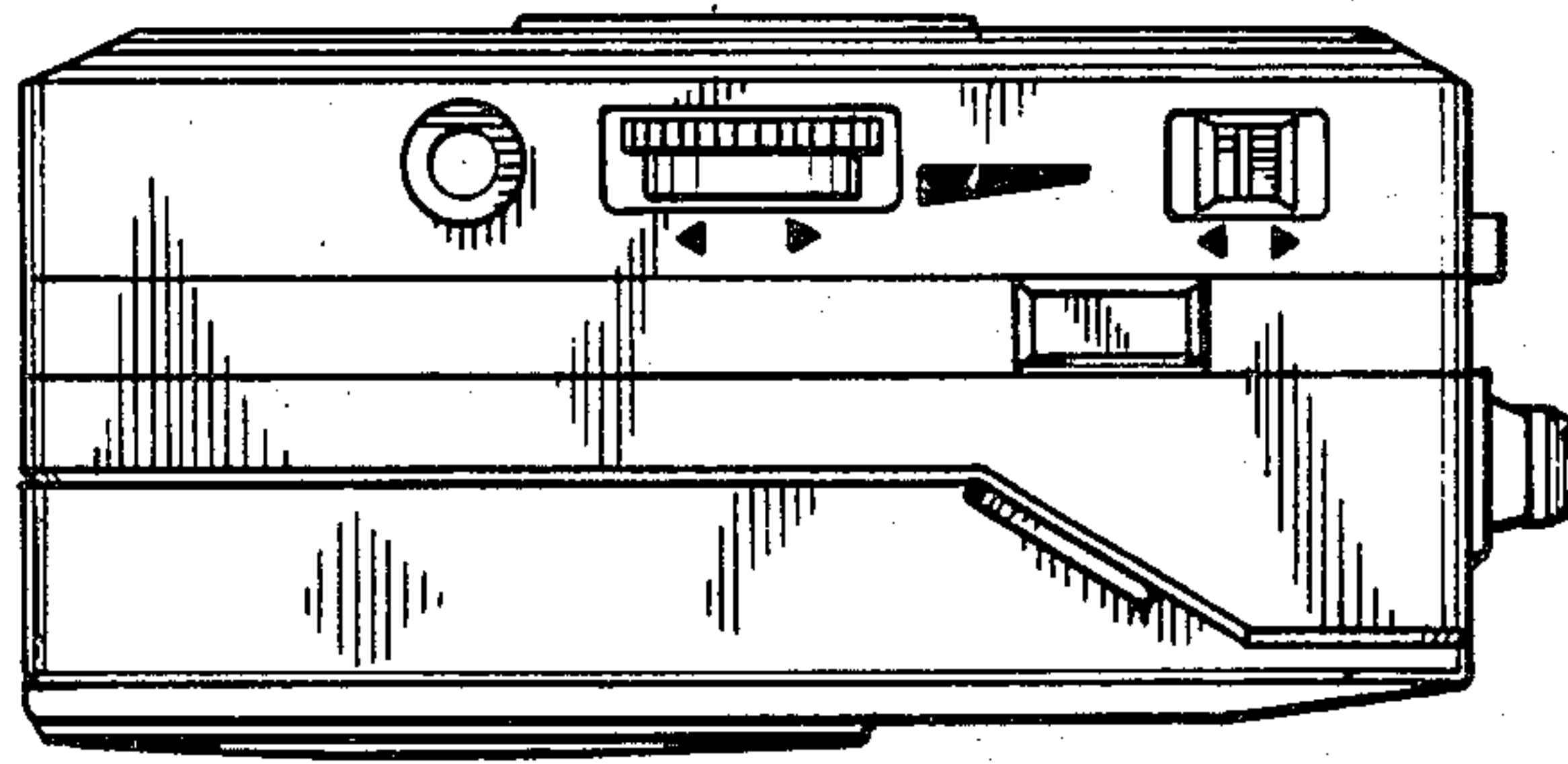

FIG. 4

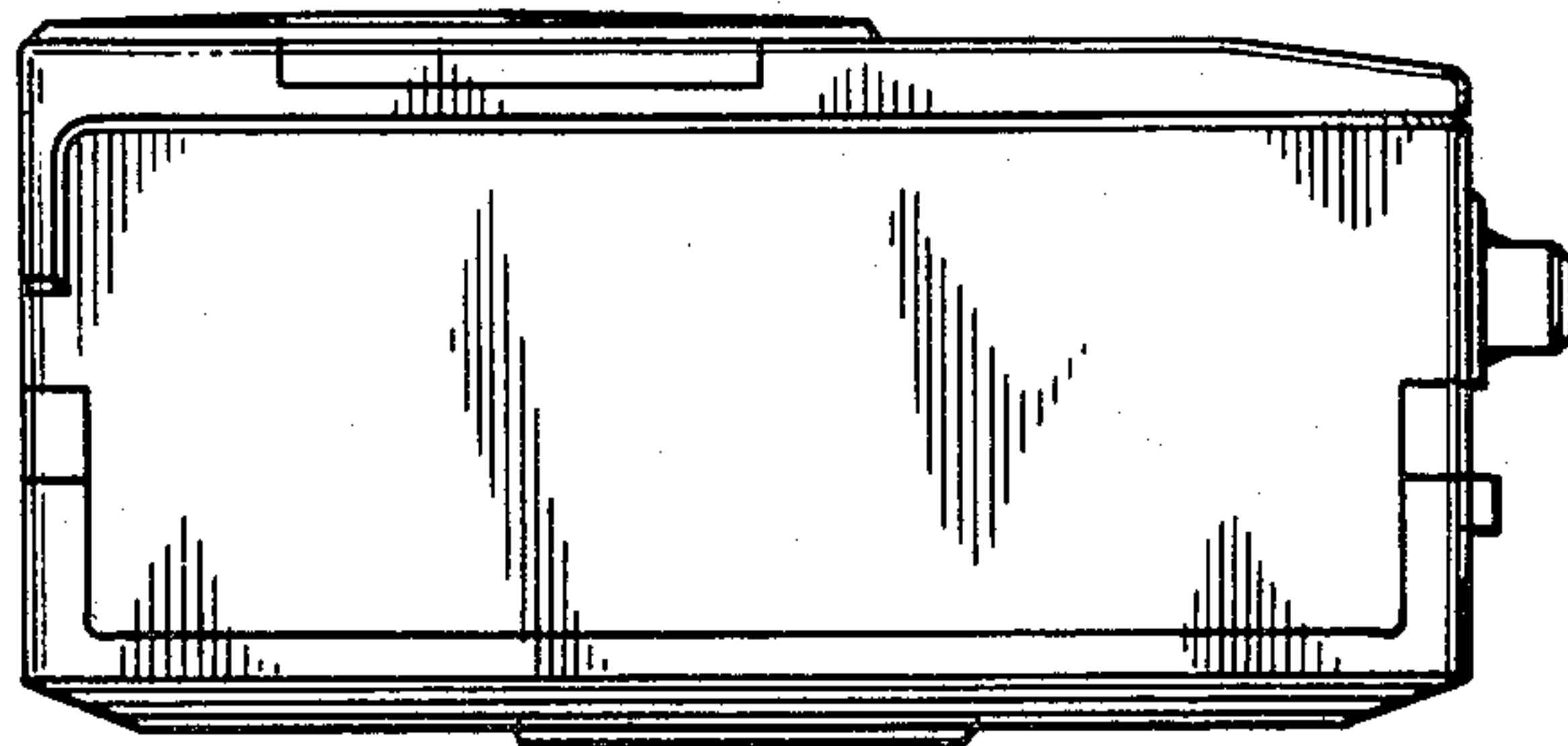

FIG. 5

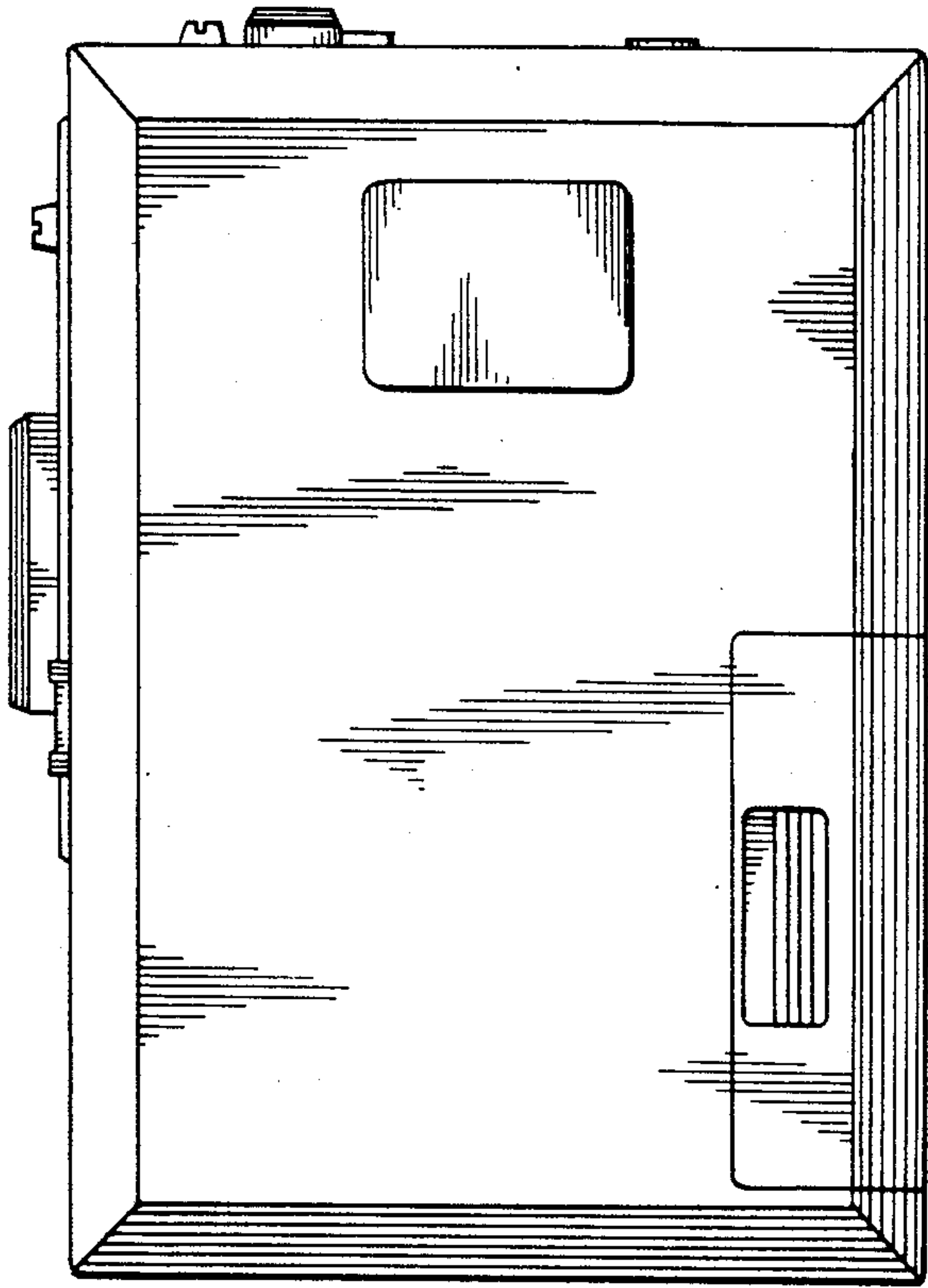

FIG. 6

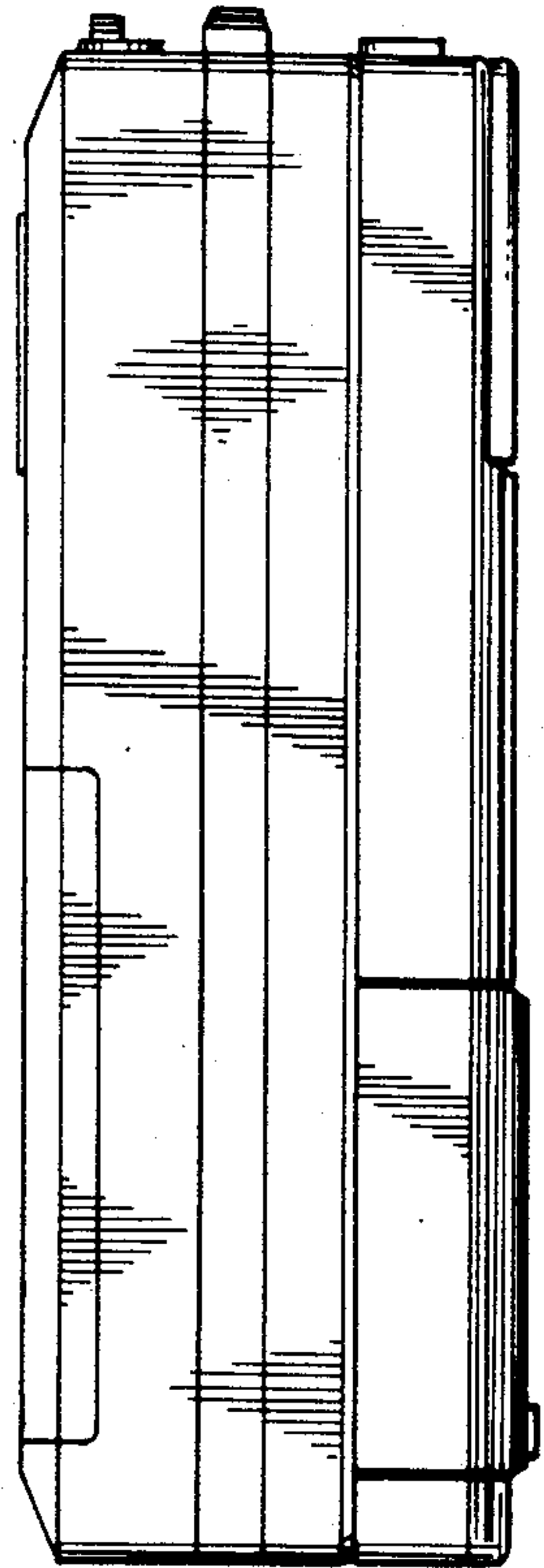

FIG. 7

