

[54] **DUAL TRAY STORAGE BIN**

[75] **Inventor: Balthasar Kirchner, Eferding, Austria**

[73] **Assignee: Ernst Stadelmann Gesellschaft M.B.H., Eferding, Austria**

[**] **Term: 14 Years**

[21] **Appl. No.: 618,541**

[22] **Filed: Jun. 8, 1984**

[52] **U.S. Cl. D34/46**

[58] **Field of Search D34/40, 42, 46, 45;
D9/424; 206/501, 503, 505, 507**

[56] **References Cited**

U.S. PATENT DOCUMENTS

D. 210,274	2/1968	Wilson	D34/40
D. 249,185	8/1978	Carroll et al.	D34/40
2,916,161	12/1959	Schaefer	D34/40 X
4,372,444	2/1983	Le Grand et al.	206/505
4,441,615	4/1984	Goodrich	206/505 X

Primary Examiner—Robert C. Spangler
Attorney, Agent, or Firm—Karl F. Ross; Herbert Dubno

[57] **CLAIM**

The ornamental design for a dual tray storage bin, as shown and described.

DESCRIPTION

FIG. 1 is a top, front perspective view of a dual tray storage bin showing my new design;

FIG. 2 is a rear elevational view thereof on an enlarged scale;

FIG. 3 is a bottom plan view thereof, the bottom of the upper tray being the same in appearance;

FIG. 4 is an enlarged fragmentary sectional view taken on line IV—IV of FIG. 1;

FIG. 5 is a front elevational view showing a modified form of my new design wherein the only change is that the upper tray has been rotated horizontally 180 degrees and the posts thereof have been omitted and the lower tray has been provided with a shorter type support post such as seen on the upper tray in FIG. 4; and

FIG. 6 is a view looking from the right of FIG. 5.

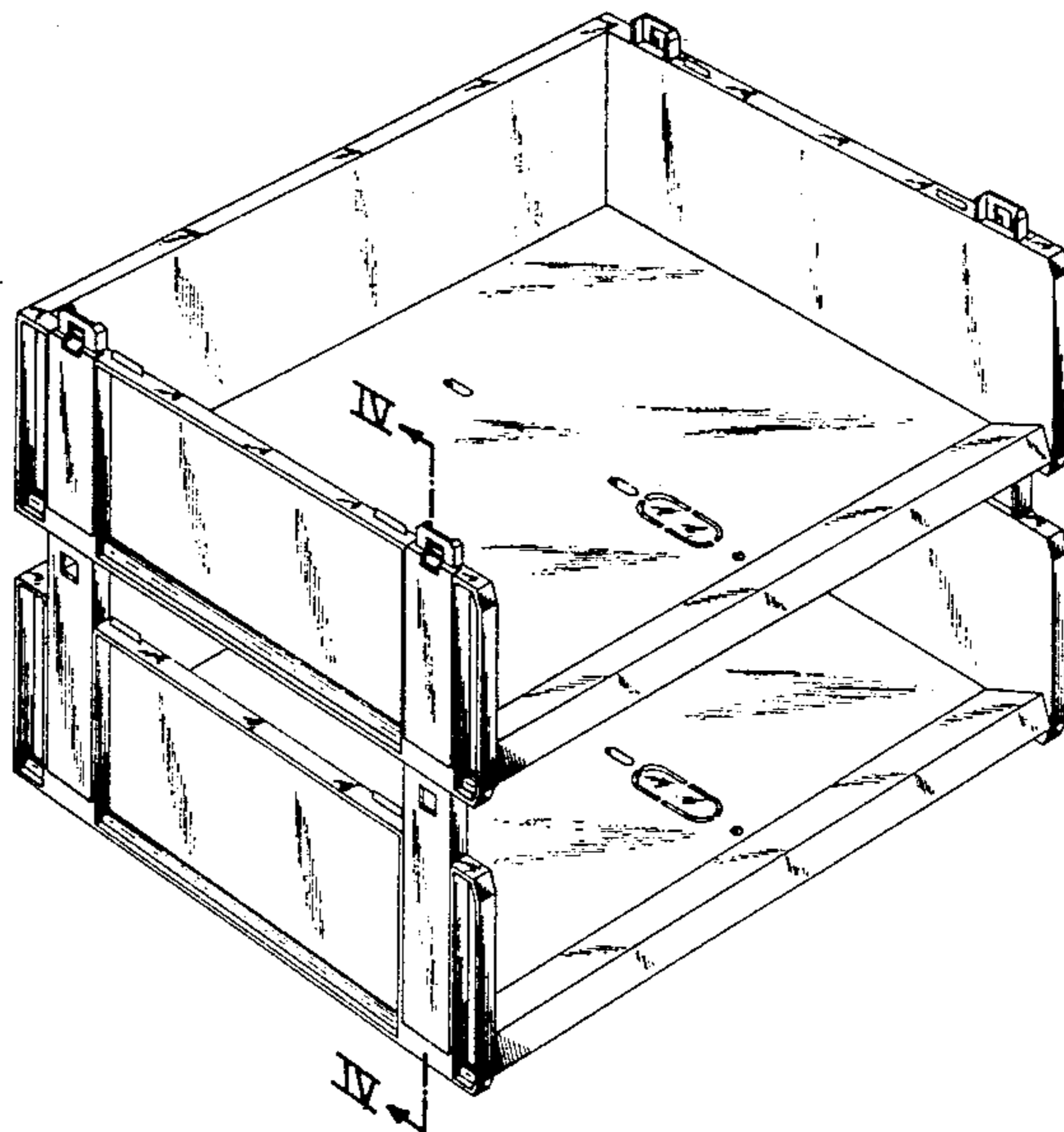

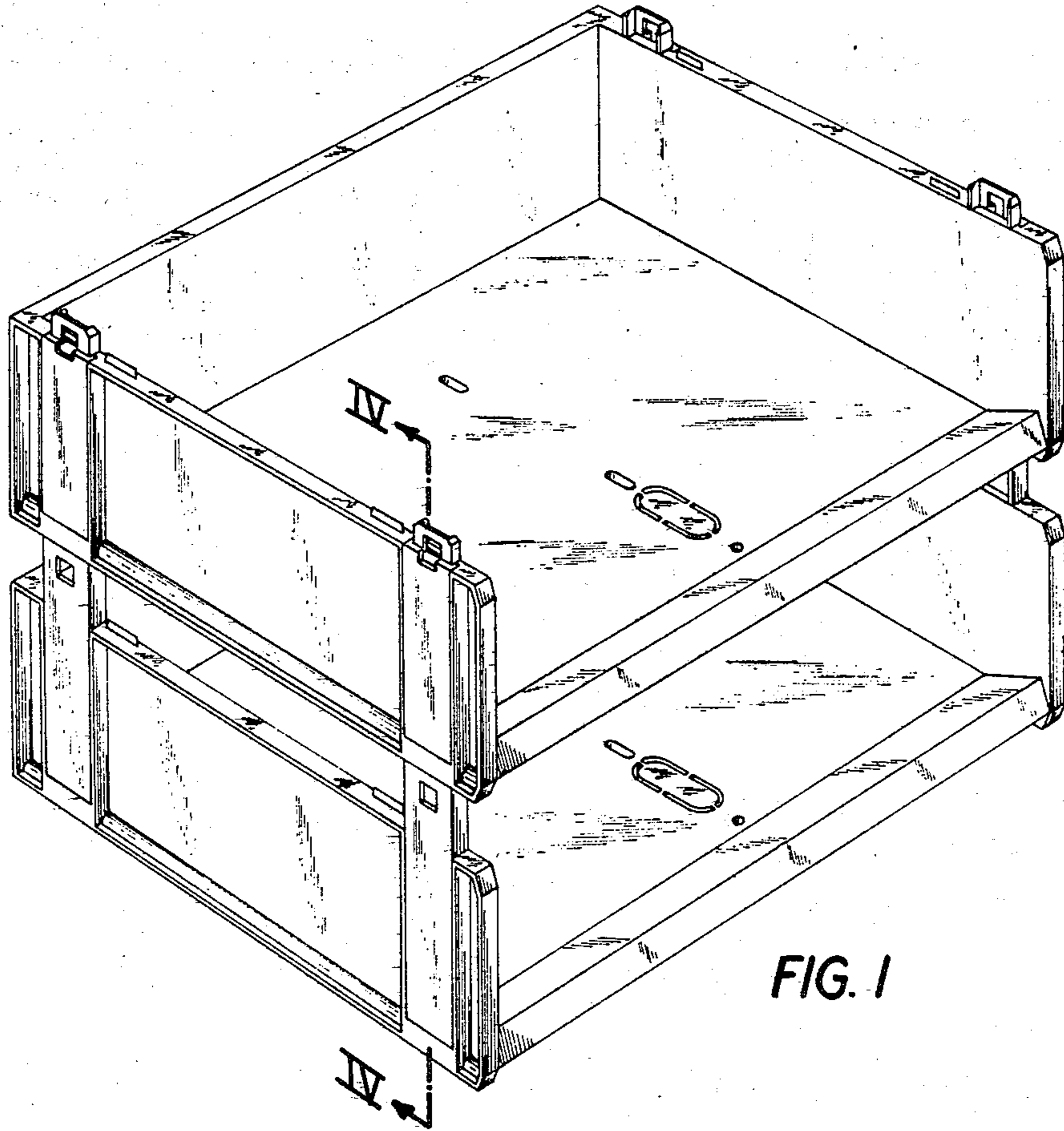

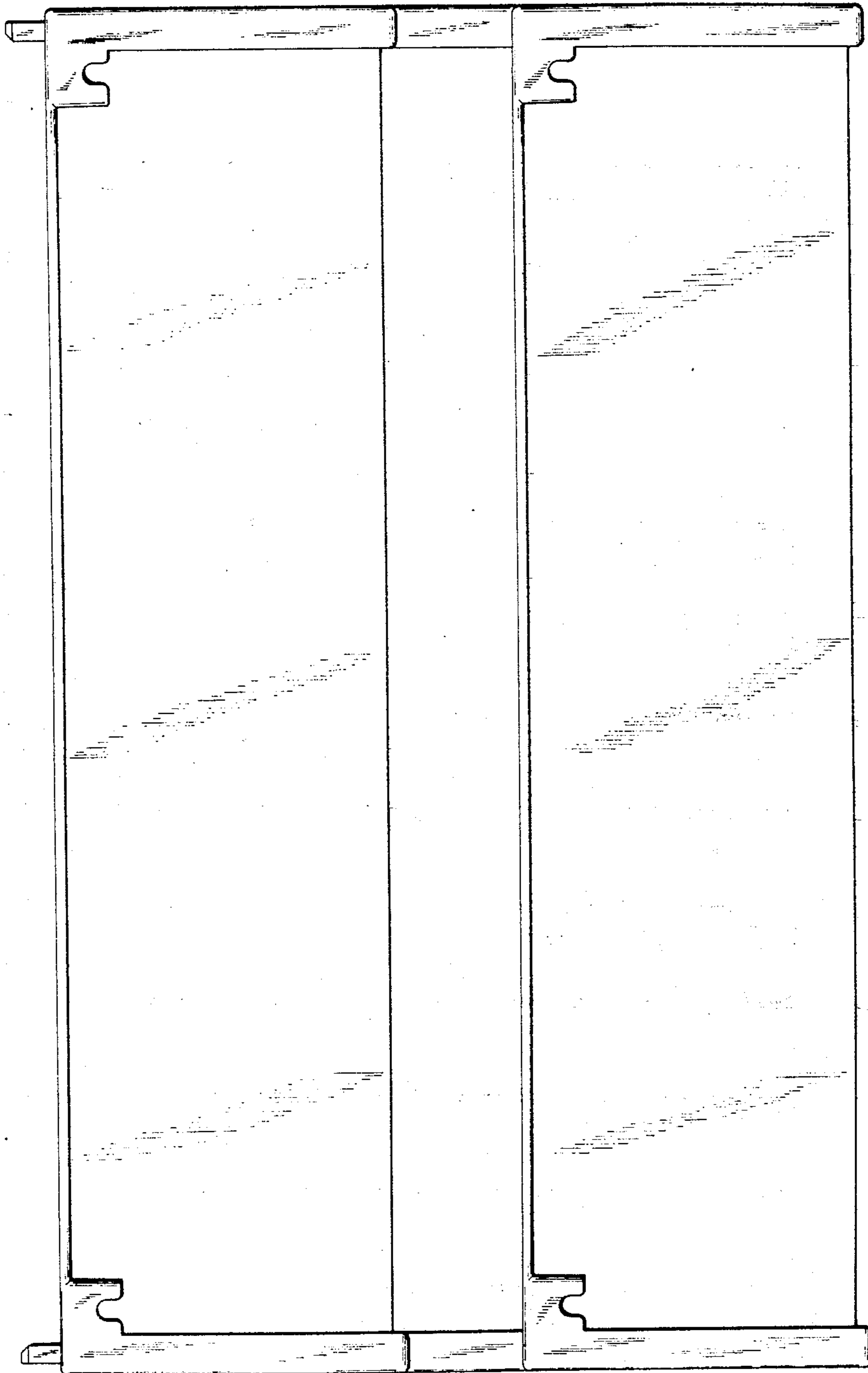
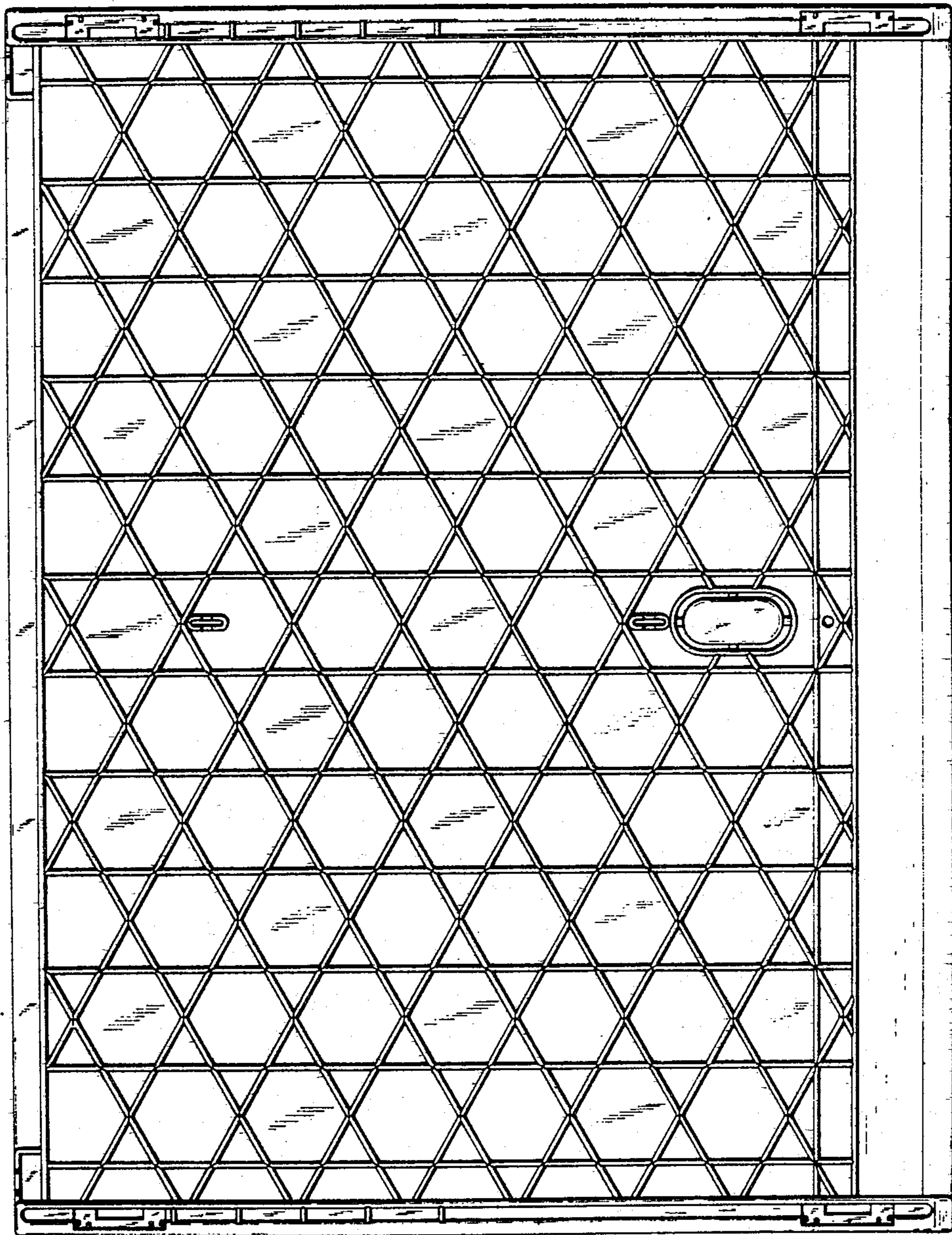

FIG. 2

FIG. 3



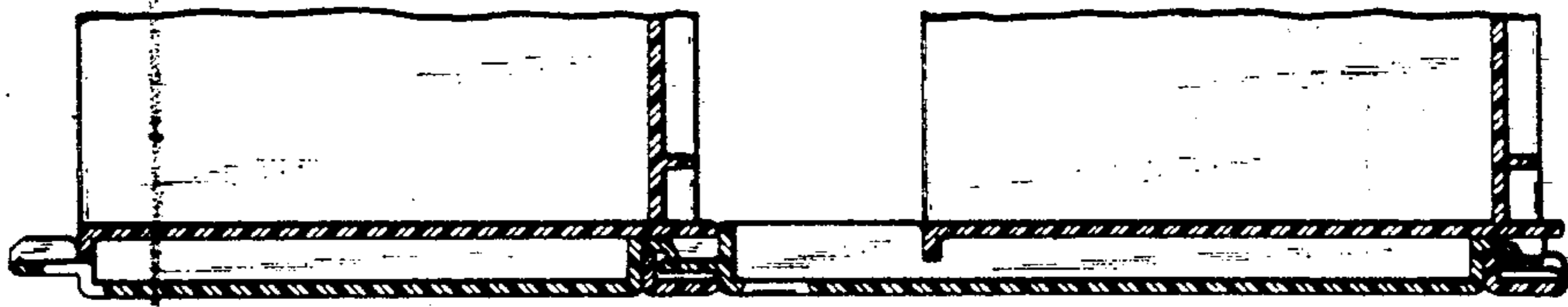

FIG. 4

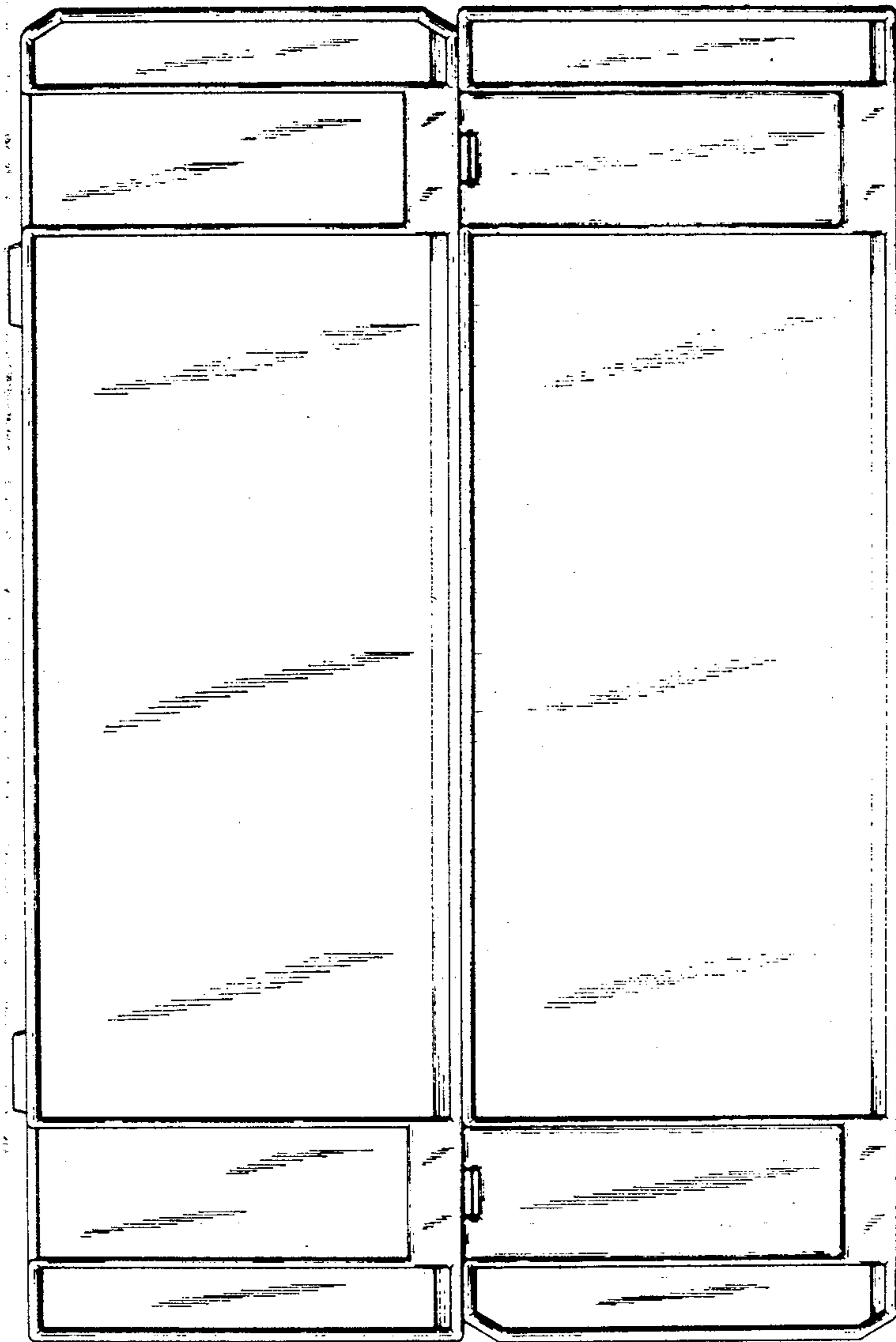

FIG. 6

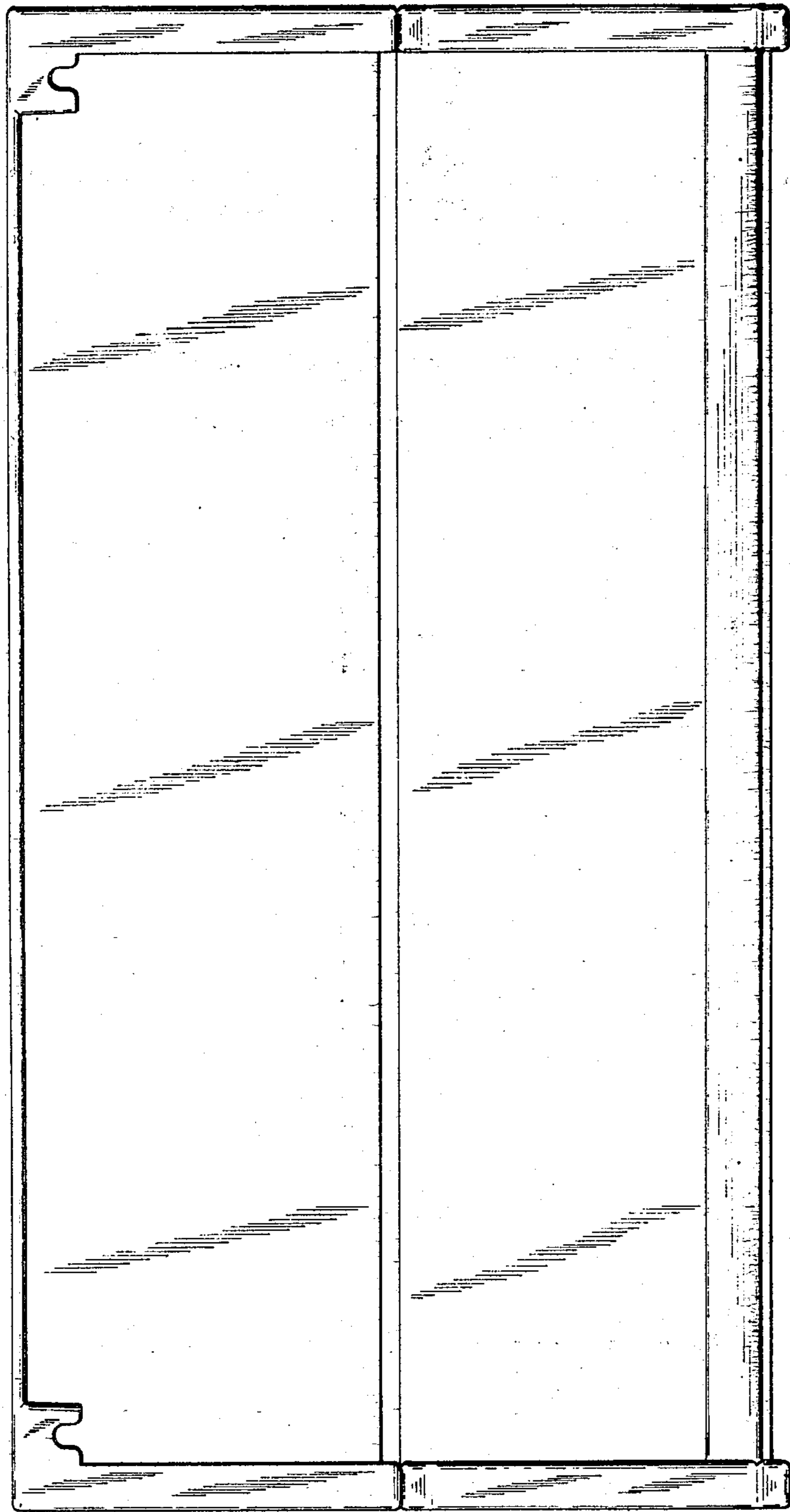

FIG. 5