

[54] SKIRT CLIP FOR SALAD BARS AND THE LIKE

[75] Inventor: Sam Fogelman, Morton Grove, Ill.

[73] Assignee: Midwest Marko, Inc., Ill.

[\*\*] Term: 14 Years

[21] Appl. No.: 621,256

[22] Filed: Jun. 15, 1984

[52] U.S. Cl. .... D8/371; D8/367

[58] Field of Search ..... D8/349, 371, 356, 367; 248/215, 301; 24/3 L, 543, 563, 457; 160/330; D6/323

3,575,371 4/1971 Carlstedl ..... 248/215  
3,905,414 9/1975 Guebert et al. .... 160/330  
4,149,299 4/1979 Welsh ..... 24/543

FOREIGN PATENT DOCUMENTS

654890 7/1951 United Kingdom ..... 248/215

Primary Examiner—Wallace R. Burke  
Assistant Examiner—Horace B. Fay  
Attorney, Agent, or Firm—Robert E. Browne

[57] CLAIM

The ornamental design for a skirt clip for salad bars and the like, substantially shown and described.

DESCRIPTION

FIG. 1 is a left side, top and front perspective view of a skirt clip for salad bars or the like showing my new design;

FIG. 2 is a left side elevational view thereof, the right side being a mirror image thereof, and the broken line is shown for environment association purposes only;

FIG. 3 is a front elevational view thereof;

FIG. 4 is a rear elevational view thereof;

FIG. 5 is a top plan view thereof; and

FIG. 6 is a bottom plan view thereof.

[56] References Cited

U.S. PATENT DOCUMENTS

D. 277,546	2/1985	Trotta	.....	D8/356
537,126	4/1895	Lieb	.....	245/215
2,157,001	8/1939	Morley	.....	248/215
2,751,653	6/1956	Lebow	.....	24/563
2,811,328	10/1957	Ericson	.....	248/301
3,164,473	9/1963	Rose	.....	24/563
3,247,558	4/1966	Kaufman	.....	24/563
3,536,287	10/1970	Kramer	.....	248/301

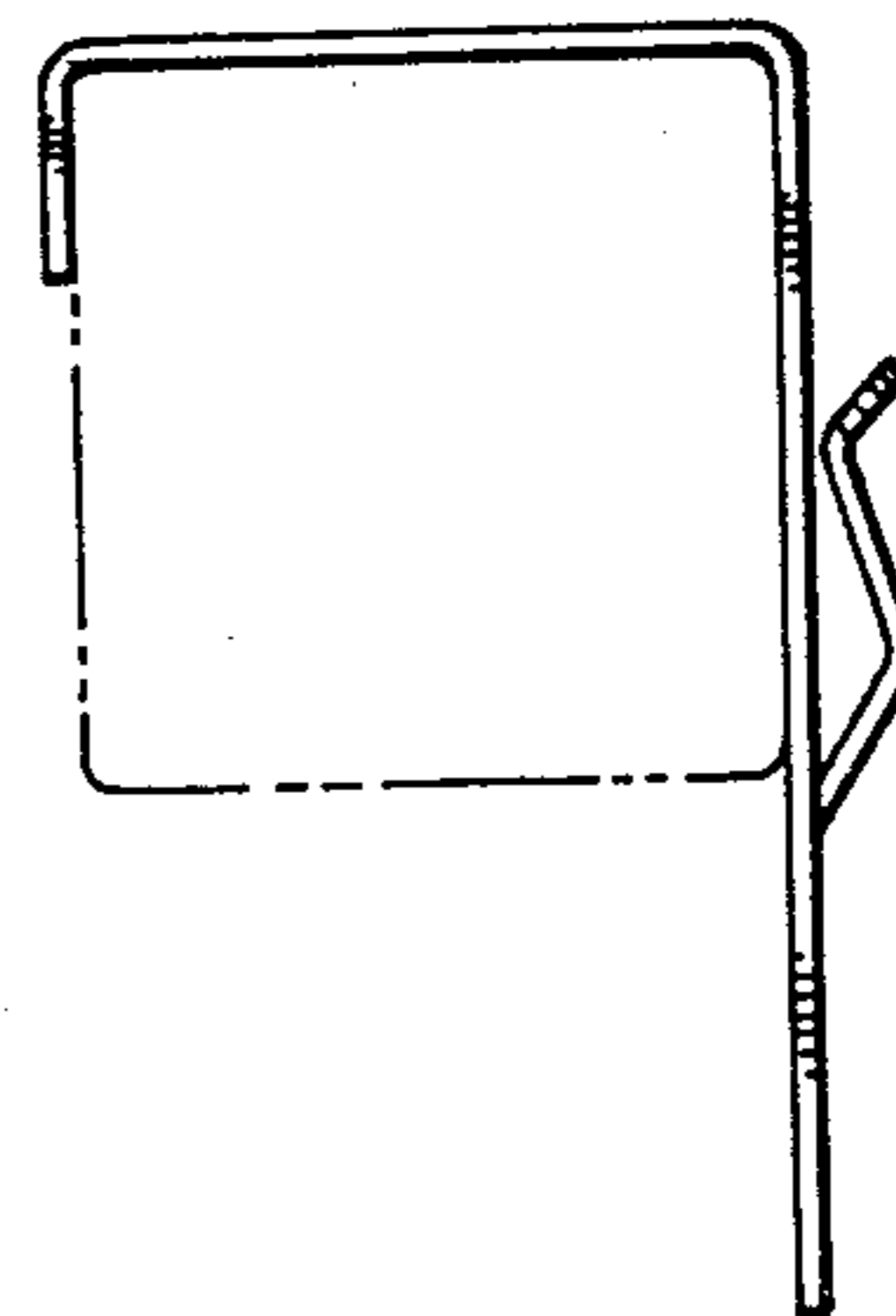
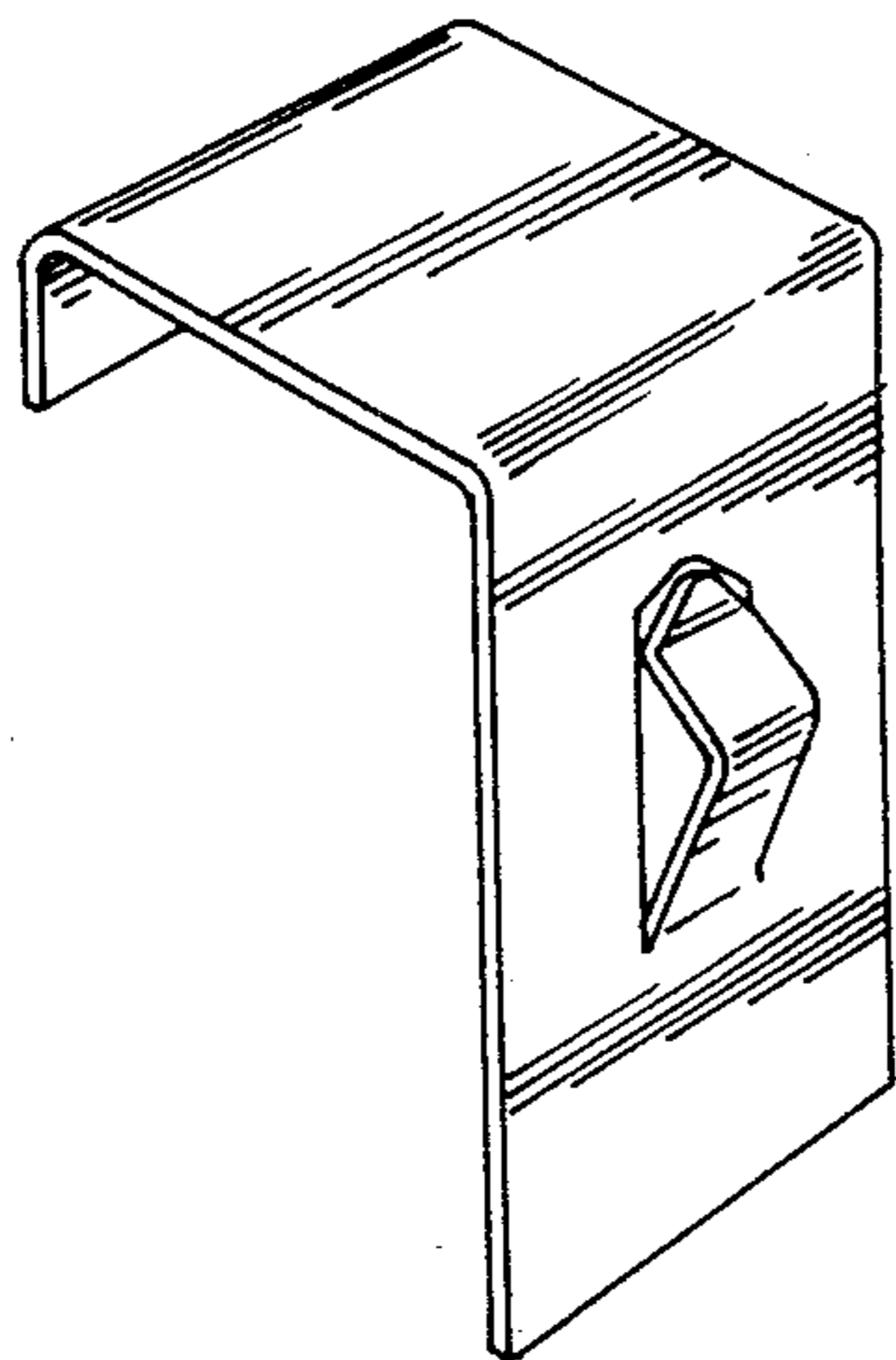

FIG. 1

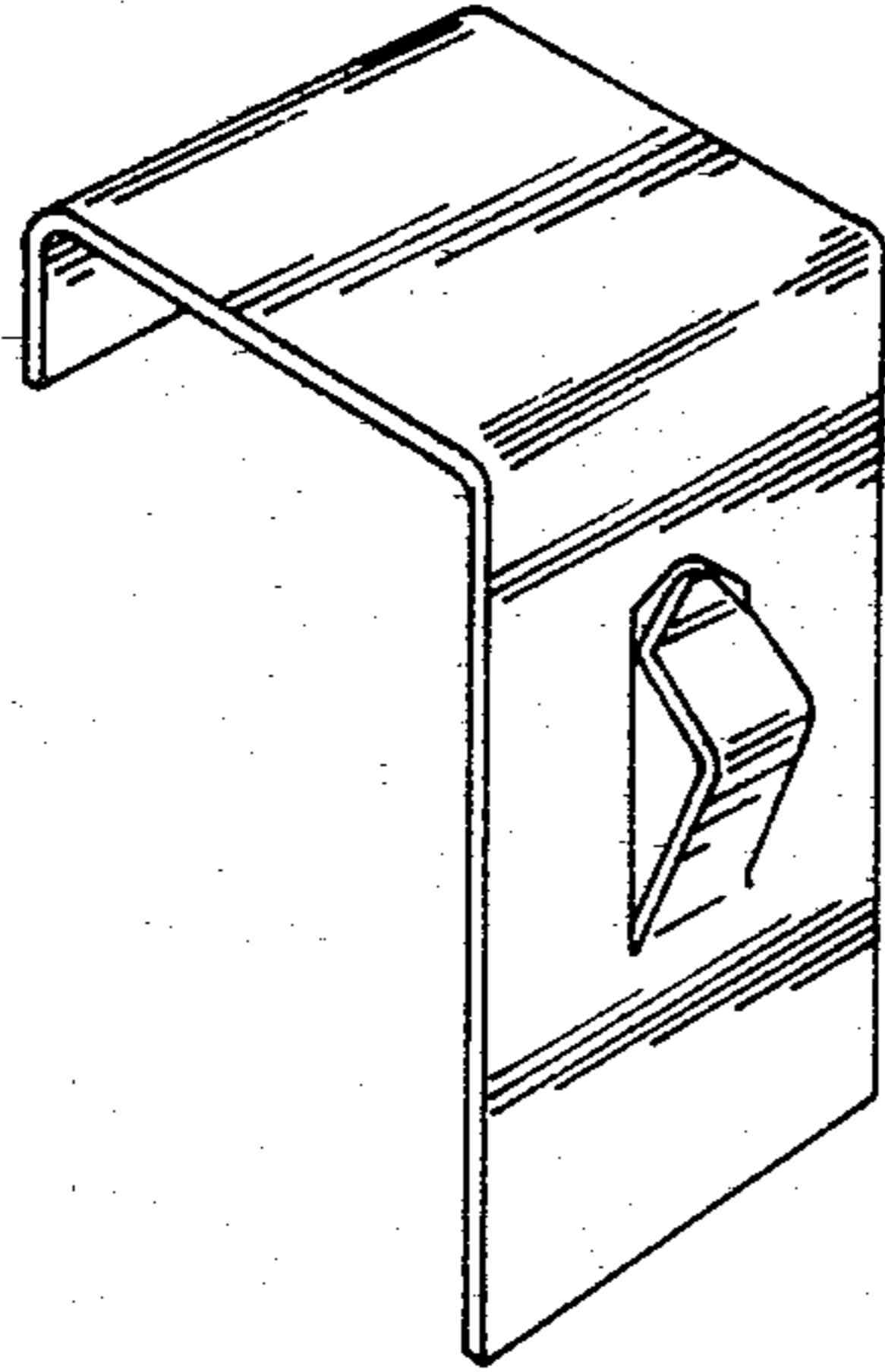

FIG. 2

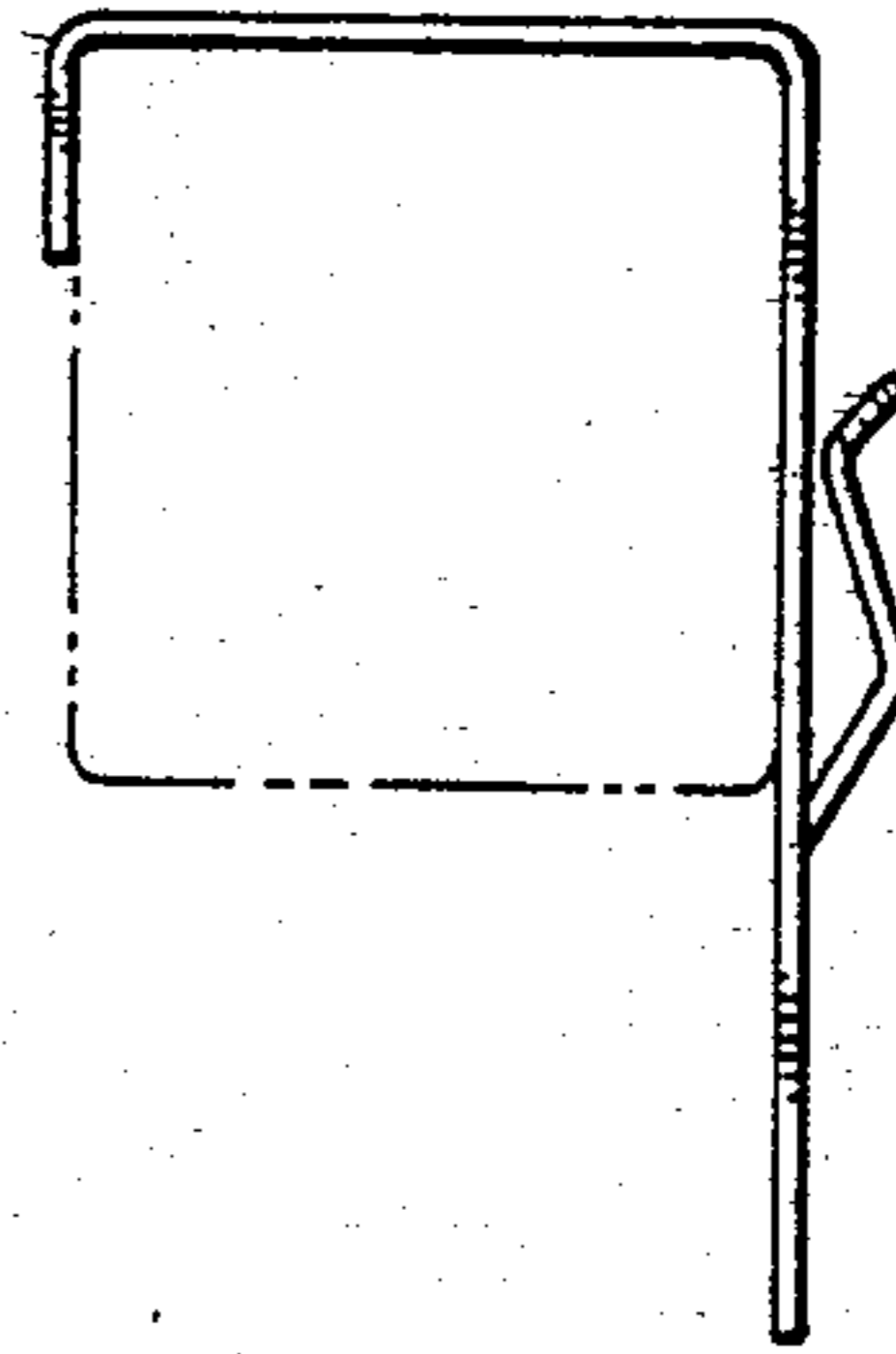

FIG. 3

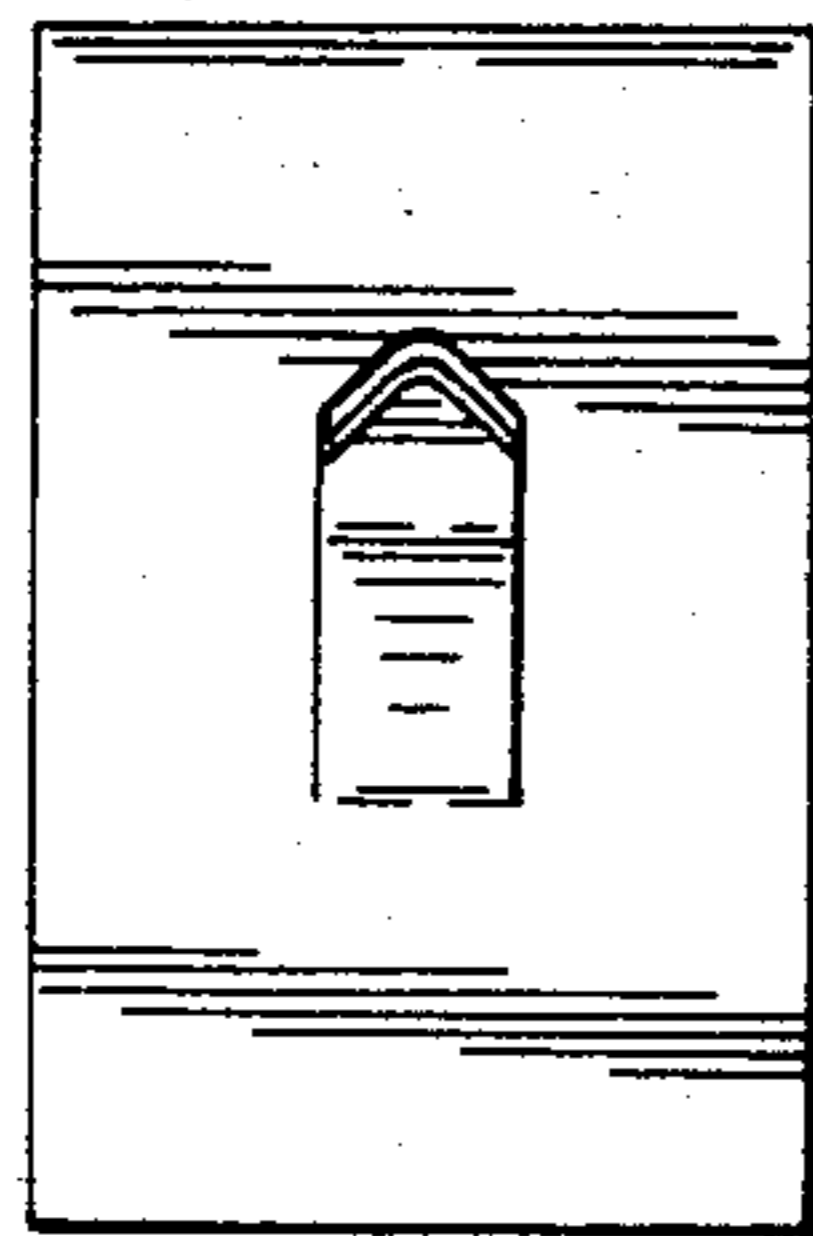

FIG. 4

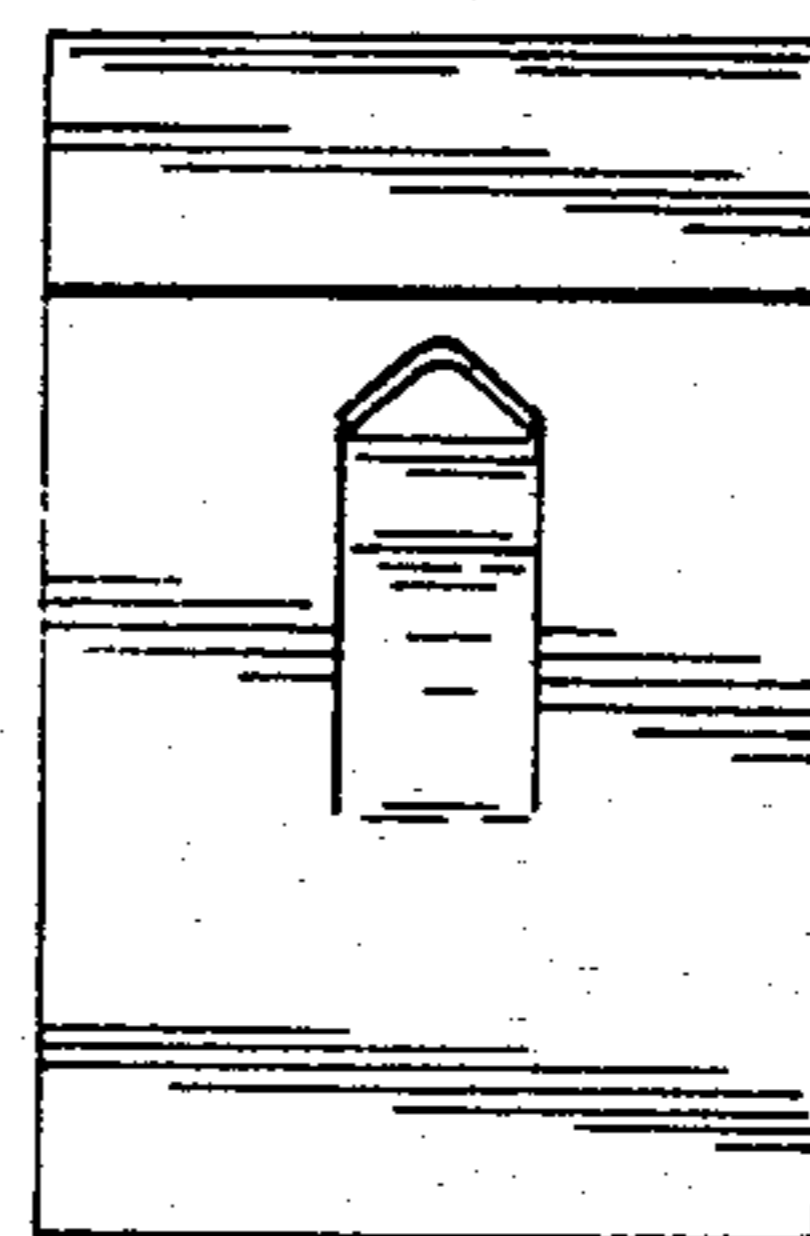

FIG. 5

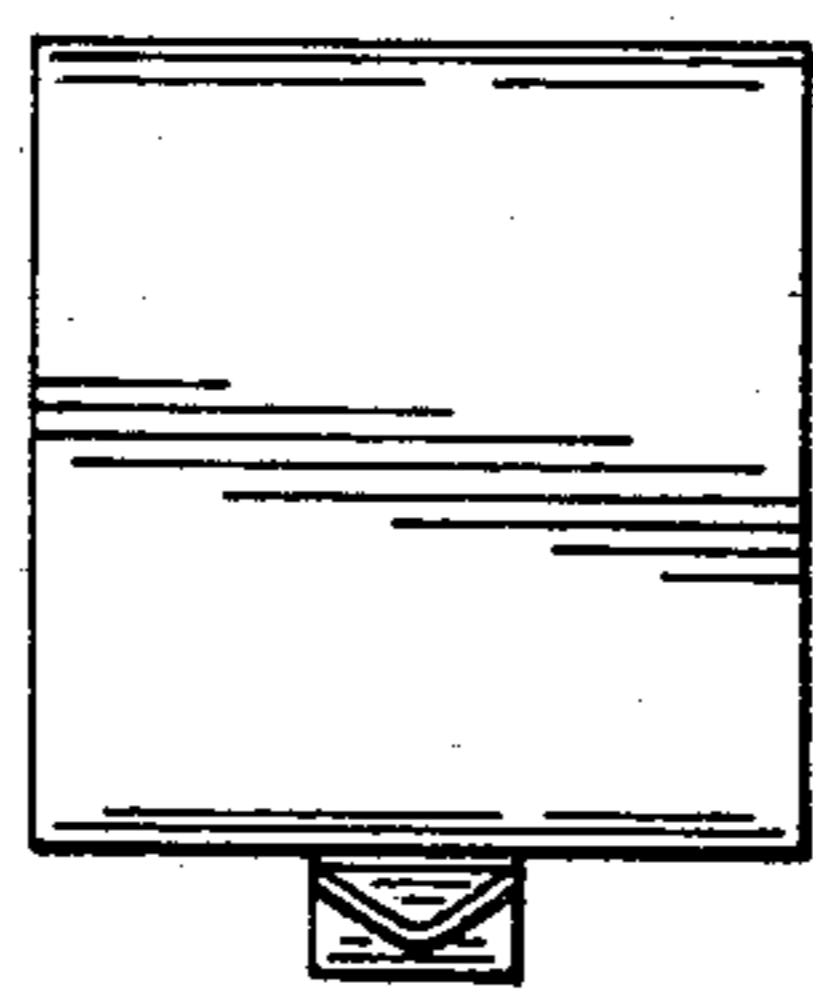

FIG. 6

