

United States Patent [19]

Buist

[11] **Patent Number: Des. 289,955**

[45] **Date of Patent: ** May 26, 1987**

[54] **COMBINED MUG AND COASTER BASE**

[75] **Inventor: Ronald W. Buist, Oakville, Canada**

[73] **Assignee: T.H.D. Donut (Delaware), Inc.,
Oakville, Canada**

[**] **Term: 14 Years**

[21] **Appl. No.: 650,037**

[22] **Filed: Sep. 13, 1984**

[30] **Foreign Application Priority Data**

Sep. 7, 1984 [CA] Canada 07-09-84-10

[52] **U.S. Cl. D7/3; D7/9;
D7/40; D7/45**

[58] **Field of Search D7/9, 10, 3, 40, 45;
220/90.4, 90.6, 90.2, 94 A, 23.83, 23.86, 23.4**

[56] **References Cited**

U.S. PATENT DOCUMENTS

- D. 9,304 5/1876 King D7/9
- D. 247,839 5/1978 Ashton D7/9 X
- D. 279,850 7/1985 Brooker et al. D7/3

- 3,680,330 8/1972 Canosa D7/9 X
- 3,698,594 10/1972 Boehlert D7/3 X
- 4,040,549 8/1977 Sadler D7/9 X

FOREIGN PATENT DOCUMENTS

- 50413 10/1982 Canada D7/3 X
- 1029516 3/1953 France 220/90.4

*Primary Examiner—Winifred E. Herrmann
Attorney, Agent, or Firm—Rogers, Bereskin & Parr*

[57] CLAIM

The ornamental design for a combined mug and coaster base, as shown.

DESCRIPTION

FIG. 1 is a top, rear and right side exploded perspective view of a combined mug and coaster base showing my new design;
 FIG. 2 is a right side exploded elevational view thereof;
 FIG. 3 is a bottom, front and left side exploded perspective view thereof;
 FIG. 4 is a top plan view thereof; and
 FIG. 5 is a front elevational view thereof.

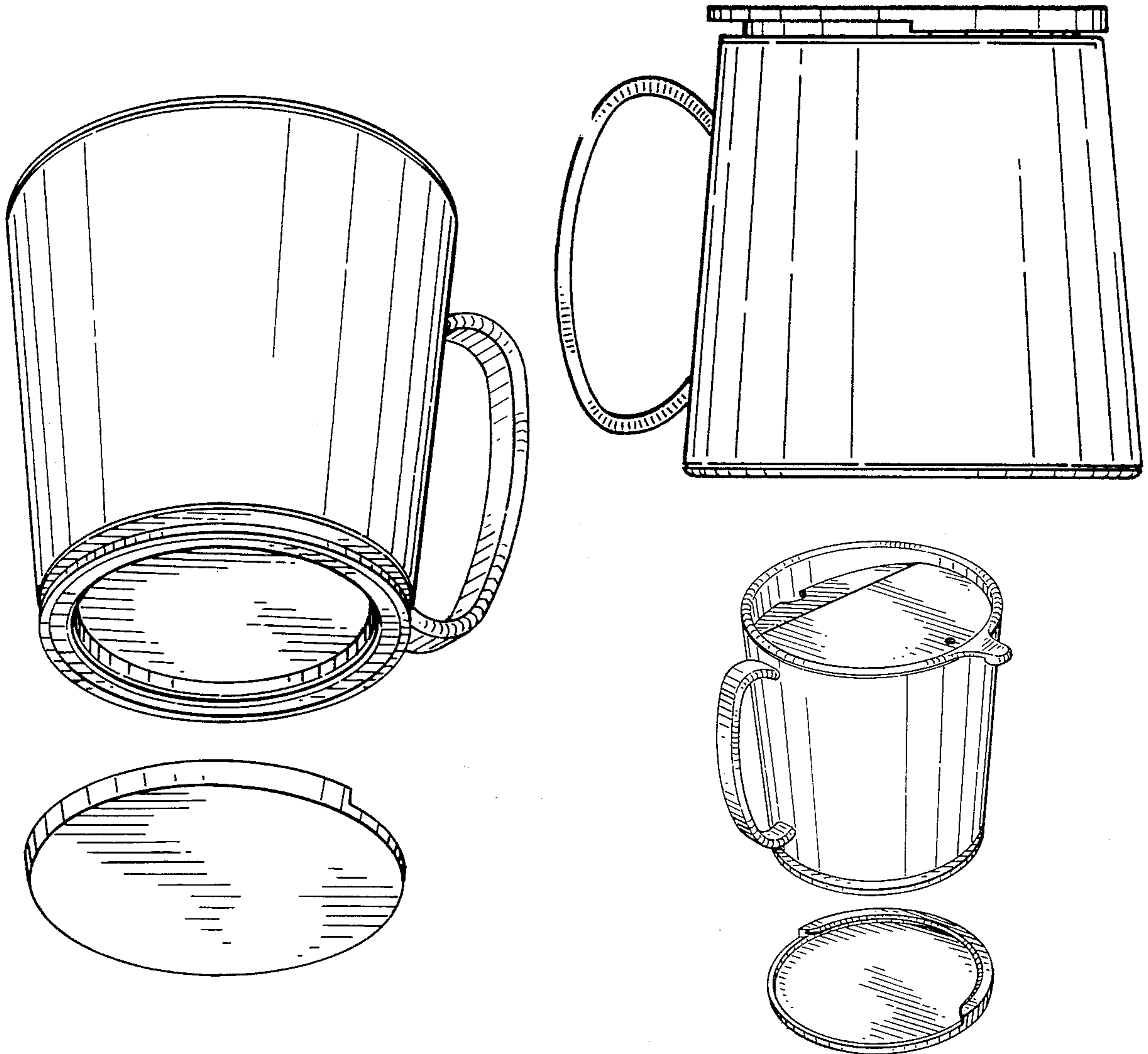

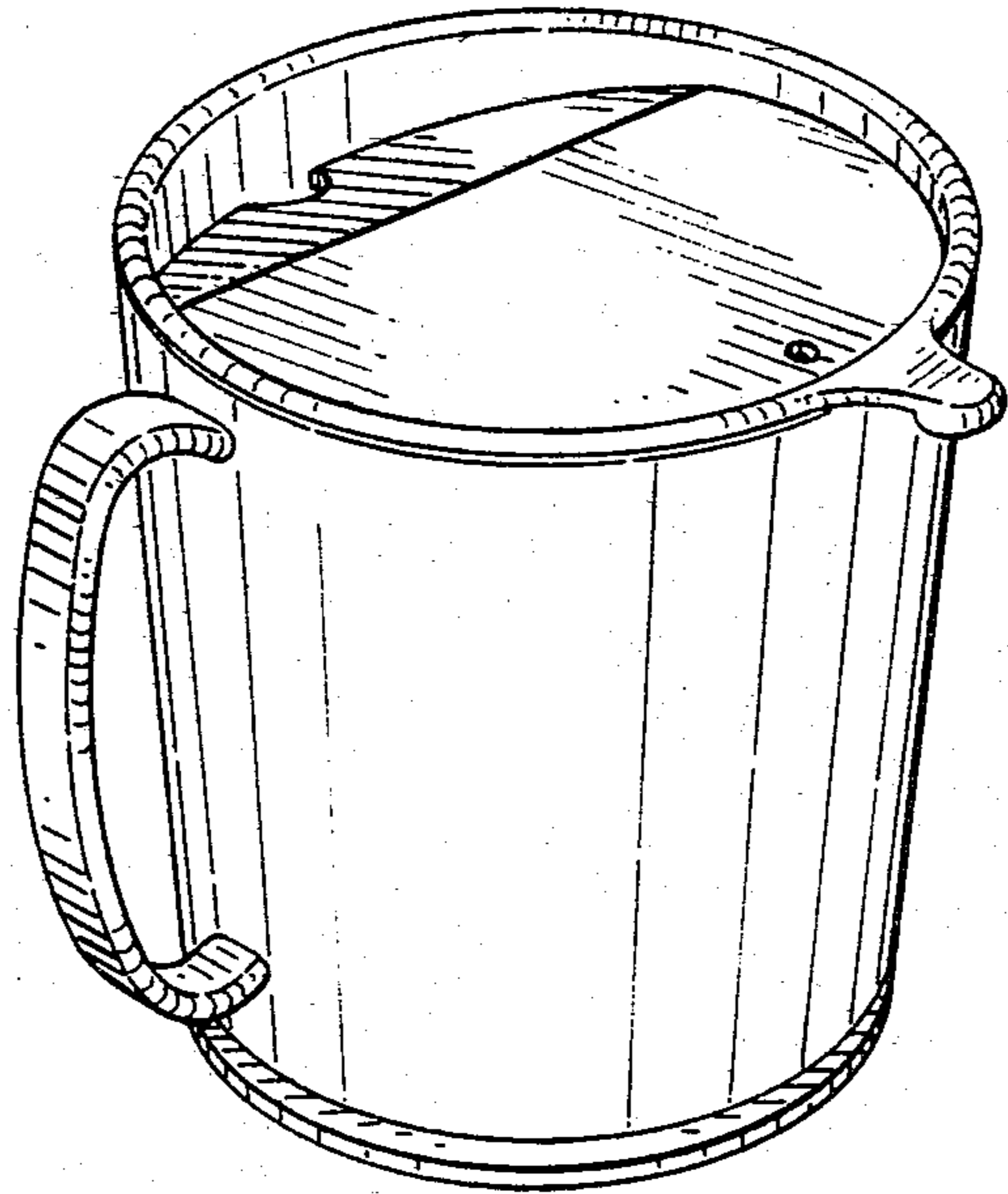

FIG. 1

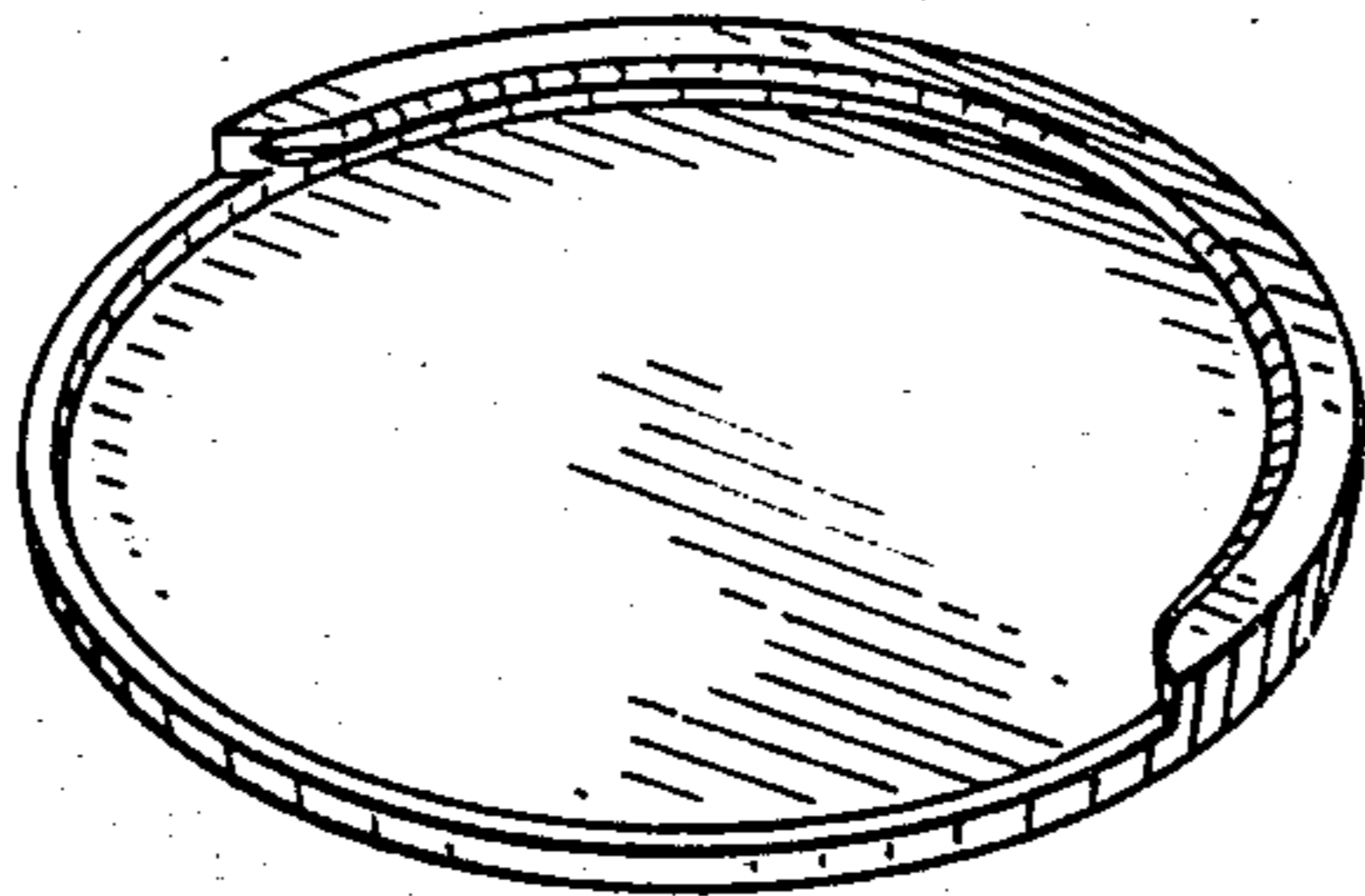
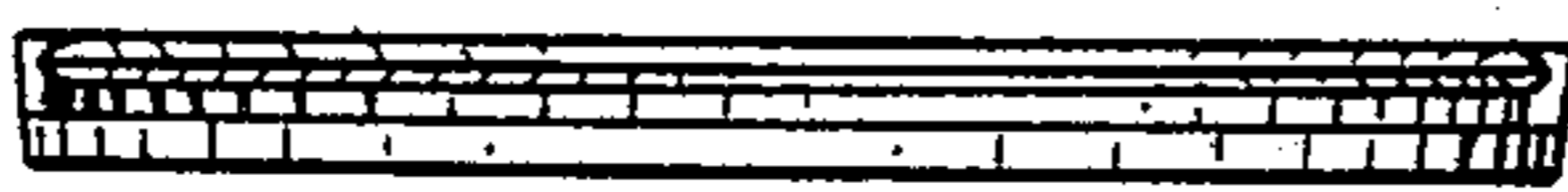
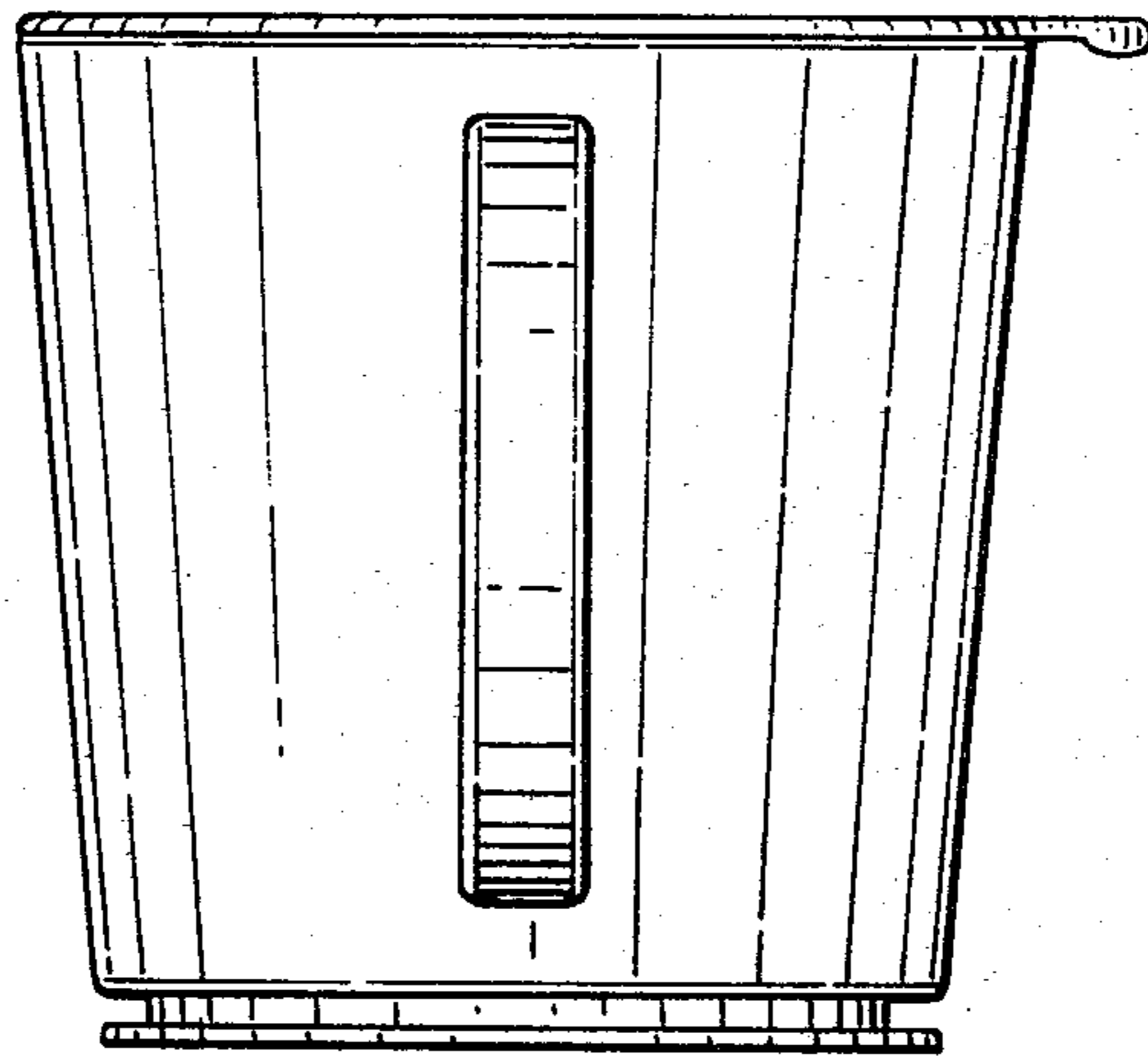

FIG. 2



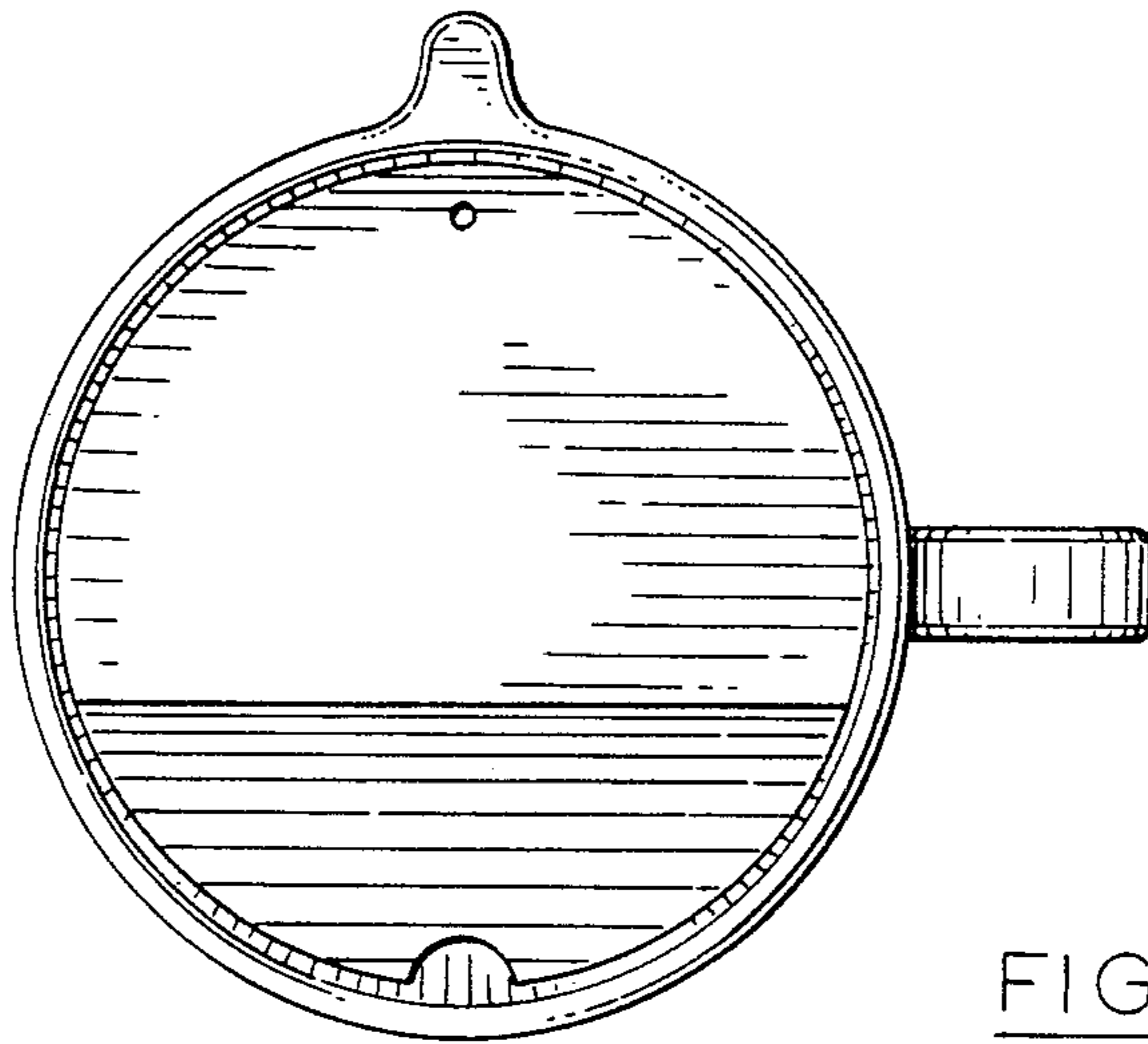
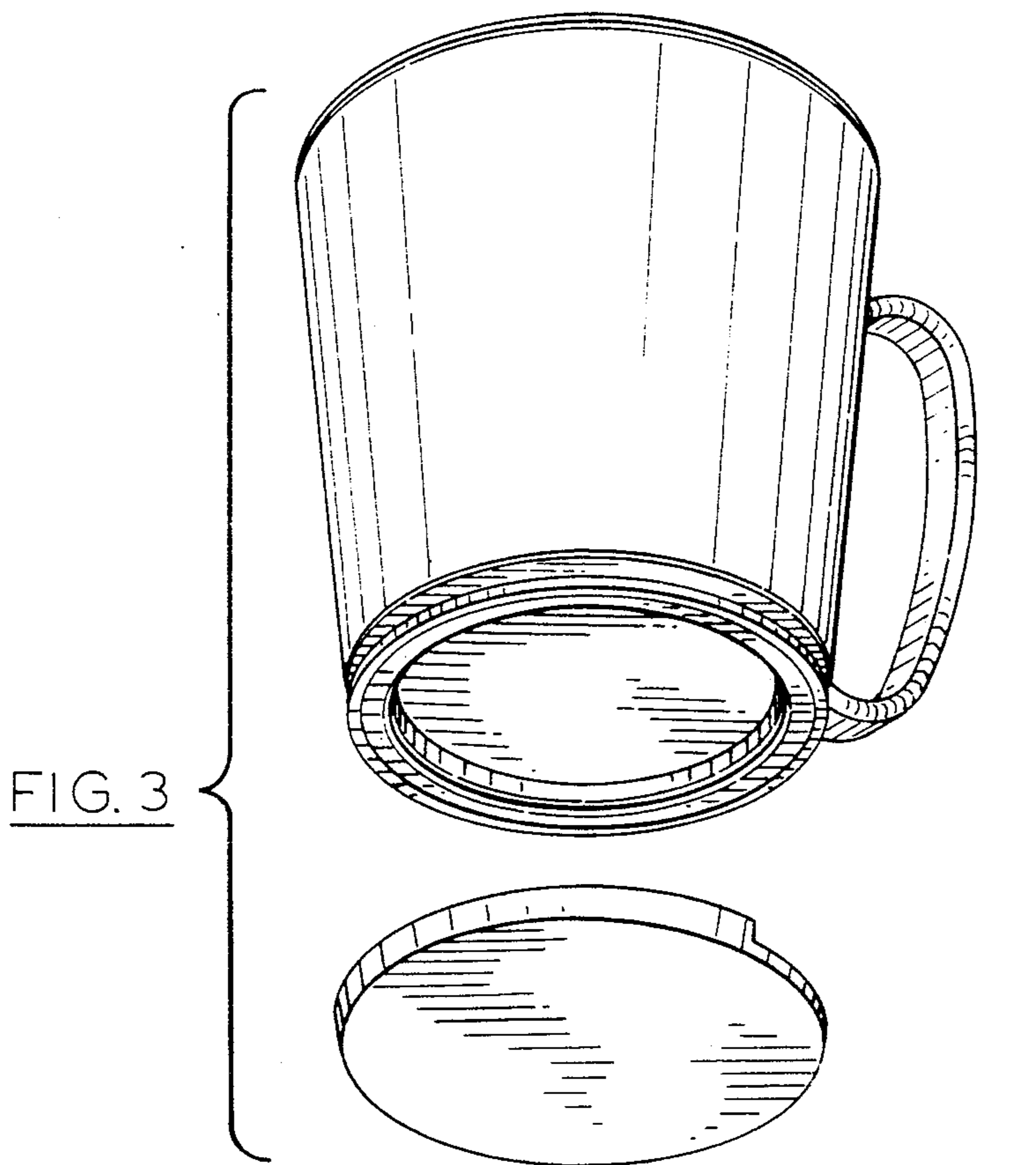

FIG. 4

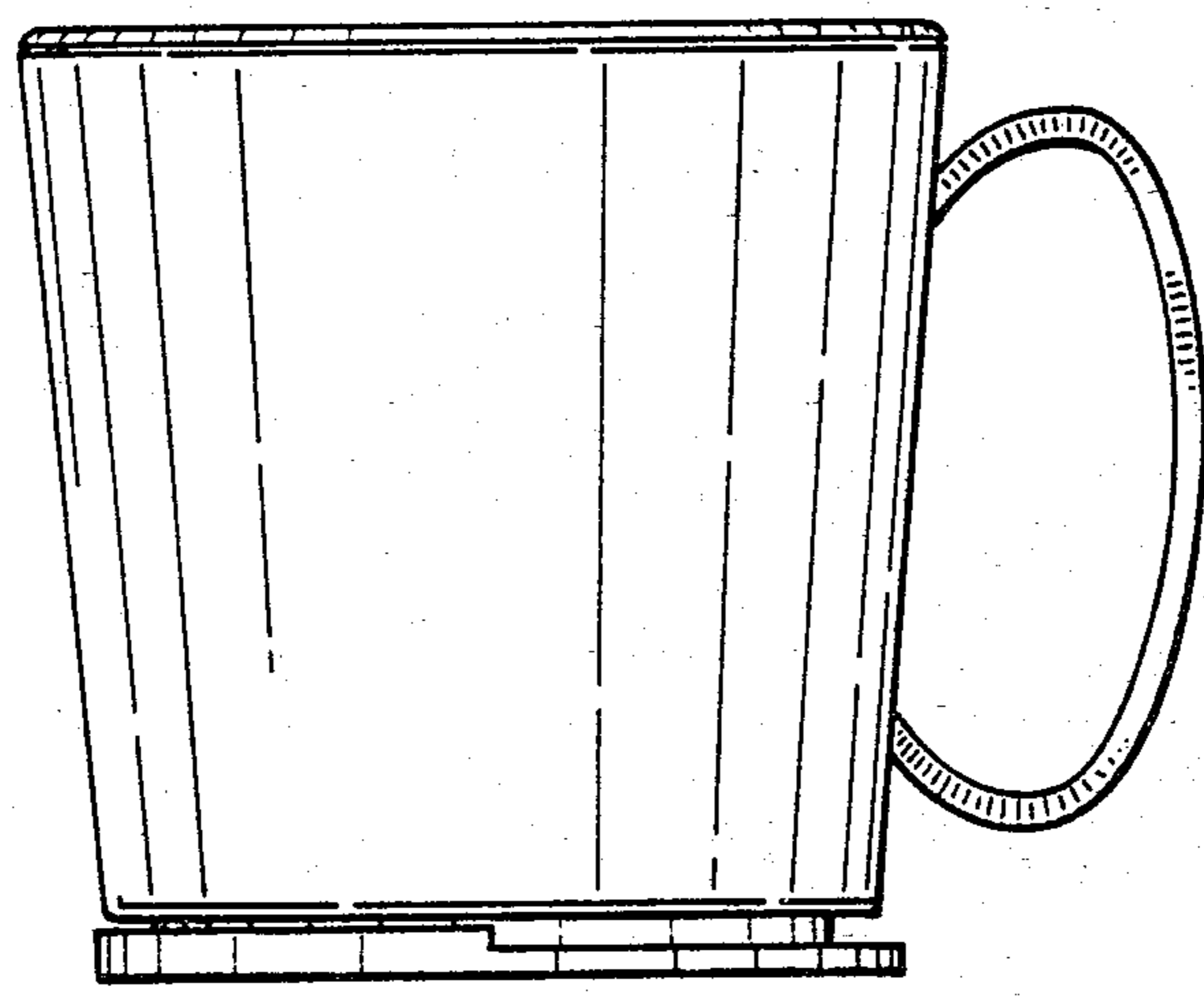

FIG. 5